



**Slip Ring Drive product manual V1.0**  
**JL/X130 – 1680**  
**JL/XHD75 - 975**



# Table of Contents

1	Warnings .....	4
1.1	General warnings .....	4
1.2	Warnings and instructions .....	4
1.3	General risks .....	6
1.4	Summary of further warnings .....	7
2	Introduction.....	8
2.1	Operation of Slip Ring Motor.....	9
2.1.1	Stator Voltage Control .....	9
2.1.2	Bi-directional control using the JLX.....	9
2.1.3	Rotor Control to optimise torque across speed range .....	10
2.1.4	Hyper-synchronous regeneration.....	11
2.2	Notes on configuration and the use of this manual .....	12
2.3	Notes on the use of the JL/X MMI .....	12
3	Control terminals .....	12
3.1	Control terminals electrical specifications .....	12
3.1.1	Universal Inputs (UIP2 – UIP9, terminals 2 to 9) .....	12
3.1.2	Analogue Outputs (AOP1 – AOP3, terminals 10 to 12) .....	12
3.1.3	Digital Inputs (DIP1 – DIP4, terminals 14 to 17) .....	12
3.1.4	Digital Input/Outputs (DIO1 – DIO4, terminals 18 to 21) .....	13
3.1.5	Digital Outputs (DOP1 – DOP3, terminals 22 to 24).....	13
3.2	Control terminals default functions.....	14
3.2.1	Universal Inputs UIP2 – UIP9 (terminals 2 to 9) .....	14
3.2.2	Analogue Outputs AOP1 – AOP3 (terminals 10 to 12) and larm (terminal 29) .....	14
3.2.3	Digital Inputs DIP1 – DIP4 (terminals 14 to 17) .....	14
3.2.4	Digital Input/Outputs DIO1 – DIO4 (terminals 18 to 21).....	15
3.2.5	Digital Outputs DOP1 – DOP3 (terminals 22 to 24).....	15
3.3	Non-programmable terminals (terminals 25 to 53) .....	15
3.3.1	Control board terminals.....	15
3.3.2	Power board terminals .....	16
4	Rating Tables .....	17
4.1	Rating Table for JL/X standard duty versions.....	17
4.2	Rating Table for JL/XHD high duty versions .....	18
4.3	Environment ratings.....	19
5	Basic wiring diagrams .....	20
5.1	Basic power control diagram .....	20
5.2	Basic analogue bipolar input speed control (as shipped, default configuration) .....	21
5.3	Basic analogue unipolar input speed control (as shipped, default configuration).....	22
5.4	Basic joystick/digital input speed control (3-key reset configuration).....	23
5.5	Basic analogue unipolar input current control (as shipped, default configuration).....	24
5.6	Basic joystick/digital input current control (3-key reset configuration).....	25
5.7	Rotor resistance control .....	26
5.8	Brake control .....	27
6	Commissioning guide .....	28
6.1	Setting up communications with Savvy software.....	28
6.1.1	JL/X not fitted with drive.web board .....	28
6.1.2	JL/X fitted with drive.web board .....	29
6.2	Basic calibration .....	32
6.2.1	Special technique for high voltage tachogenerators .....	33
6.2.2	Special technique for reducing JL/X current rating .....	33
6.3	Functional settings.....	35
6.3.1	Ramp times .....	35
6.3.2	Brake settings.....	36
6.3.3	Hyper-synchronous detection settings .....	39
6.3.4	Scaling the external speed demand and setting the hyper-synchronous demand detector .....	41
6.3.5	Adjusting stator firing angle minimum delay .....	44
6.3.6	Rotor resistance control settings .....	46
6.4	Speed and current loop tuning .....	48
6.4.1	Current loop tuning.....	48
6.4.2	Speed loop tuning .....	56

6.4.3	Special techniques for highly inductive stators .....	63
7	Alarms .....	64
7.1	Stator Overcurrent .....	65
7.2	Overspeed.....	65
7.3	Stator Overvoltage .....	65
7.4	Missing pulse.....	65
7.5	Stall.....	66
7.6	Motor Thermistor (T30).....	66
7.7	Heatsink Overtemp.....	66
7.8	Shorted Digital Output .....	66
7.9	Bad Reference Exchange .....	66
7.10	Contactors Lockout .....	67
7.11	User or drive.web .....	67
7.12	Synchronization loss .....	67
7.13	EL1/2/3 Phase Loss.....	67
7.14	Special note concerning speed feedback mismatch alarm .....	68
8	Mechanical Dimensions .....	69
8.1	Frame 2 JL/X130 – 270 and JL/XHD75 - 160 .....	69
8.2	Frame 4 JL/X370 – 780 and JL/XHD220- 470 .....	70
8.3	Frame 5 JL/X860 – 1680 and JL/XHD520 - 1010 .....	71
9	Venting .....	72
9.1	General venting information for frame 4 and 5 .....	72
9.2	When venting kit impractical for frame 4 and 5 .....	72
9.3	Venting kit for frame 4 .....	72
9.4	Frame 4 and 5 venting kit diagram .....	73
9.5	Venting kit for frame 5 .....	73
9.6	Air supply to enclosure .....	74
9.7	Exhaust air .....	74
9.8	Venting summary .....	74
9.9	Diagram of airflow for frame 4 and 5.....	75
10	Product rating labels .....	76
11	Semiconductor fusing .....	77
11.1	L1,2,3 supply fusing total clearing I <sup>2</sup> t ratings.....	77
11.1.1	Standard 150% overload models.....	77
11.1.2	HD 250% overload models .....	77
11.2	Bardac part numbers for L1,2,3 supply fuses/fuseholders.....	78
11.2.1	Standard 150% overload models.....	78
11.2.2	HD 250% overload models .....	78
12	Line reactors .....	79
13	Installation .....	79
13.1	Lifting the frame 4 and 5 units .....	79
13.2	Terminal tightening torques.....	79
13.3	Forces applied to the power terminals .....	80
13.4	Installation guide for EMC.....	80
13.5	Guidelines for earthing and screening .....	80
13.6	Guidelines when using supply filters.....	81
14	JL/X block diagrams .....	82
14.1	Normal page default block diagrams .....	82
14.2	3-key reset page default block diagrams.....	89
15	Record of manual modifications.....	90

# 1 Warnings

## 1.1 General warnings

### PLEASE READ AND UNDERSTAND THIS MANUAL BEFORE APPLYING POWER TO THE JL/X DRIVE UNIT

The JL/X motor drive controller is an open chassis component for use in a suitable enclosure

Drives and process control systems are a very important part of creating better quality and value in the goods for our society, but they must be designed, installed and used with great care to ensure everyone's SAFETY.

Remember that the equipment you will be using incorporates...

High voltage electrical equipment

Powerful rotating machinery with large stored energy

Heavy components

Your process may involve...

Hazardous materials

Expensive equipment and facilities

Interactive components

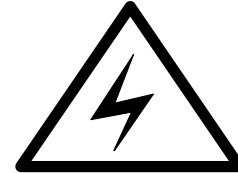

DANGER  
ELECTRIC SHOCK RISK

Always use qualified personnel to design, construct and operate your systems and keep **SAFETY** as your primary concern.

Thorough personnel training is an important aid to **SAFETY** and productivity.

**SAFETY** awareness not only reduces the risk of accidents and injuries in your plant, but also has a direct impact on improving product quality and costs.

If you have any doubts about the **SAFETY** of your system or process, consult an expert immediately. Do not proceed without doing so.

### HEALTH AND SAFETY AT WORK

Electrical devices can constitute a safety hazard. It is the responsibility of the user to ensure the compliance of the installation with any acts or bylaws in force. Only skilled personnel should install and maintain this equipment after reading and understanding this instruction manual. If in doubt refer to supplier.

**Important note:** The contents of this manual are believed to be accurate at the time of printing. However the manufacturers reserve the right to change the content and product specification without notice. No liability is accepted for omissions or errors. No liability is accepted for the installation or fitness for purpose or application of the JL/X motor drive unit.

## 1.2 Warnings and instructions

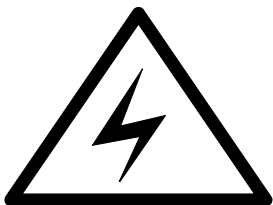

### WARNING

Only qualified personnel who thoroughly understand the operation of this equipment and any associated machinery should install, start-up or attempt maintenance of this equipment. Non compliance with this warning may result in personal injury and/or equipment damage. Never work on any control equipment without first isolating all power supplies from the equipment. The JL/X and motor must be connected to an appropriate safety earth. Failure to do so presents an electrical shock hazard.



### CAUTION

This equipment was tested before it left the factory. However, before installation and start-up, inspect all equipment for transit damage, loose parts, packing materials etc. This product conforms to IP00 protection. Due consideration should be given to environmental conditions of installation for safe and reliable operation. Never perform high voltage resistance checks on the wiring without first disconnecting the product from the circuit being tested.

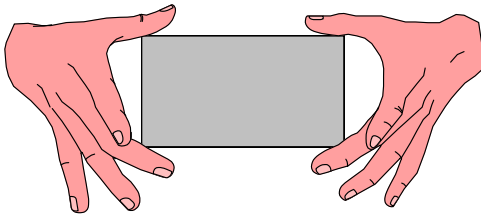

### STATIC SENSITIVE

This equipment contains electrostatic discharge (ESD) sensitive parts. Observe static control precautions when handling, installing and servicing this product.

**THESE WARNINGS AND INSTRUCTIONS ARE INCLUDED TO ENABLE THE USER TO OBTAIN MAXIMUM EFFECTIVENESS AND TO ALERT THE USER TO SAFETY ISSUES**

**APPLICATION AREA:** Industrial (non-consumer) "Motor speed control utilising slip ring motors".

**PRODUCT MANUAL:** This manual is intended to provide a description of how the product works. It is not intended to describe the apparatus into which the product is installed.

This manual is to be made available to all persons who are required to design an application, install, service or come into direct contact with the product.

**APPLICATIONS ADVICE:** Application advice and training is available from Bardac Corporation.

### 1.3 General risks

**INSTALLATION:** THIS PRODUCT IS CLASSIFIED AS A COMPONENT AND MUST BE USED IN A SUITABLE ENCLOSURE



Ensure that mechanically secure fixings are used as recommended.  
Ensure that cooling airflow around the product is as recommended.  
Ensure that cables and wire terminations are as recommended and clamped to required torque.  
Ensure that a competent person carries out the installation and commissioning of this product.  
Ensure that the product rating is not exceeded.

**APPLICATION RISK:** ELECTROMECHANICAL SAFETY IS THE RESPONSIBILITY OF THE USER



The integration of this product into other apparatus or systems is **not** the responsibility of the manufacturer or distributor of the product.  
The applicability, effectiveness or safety of operation of this equipment, or that of other apparatus or systems is **not** the responsibility of the manufacturer or distributor of the product.

Where appropriate the user should consider some aspects of the following risk assessment.

**RISK ASSESSMENT:** Under fault conditions or conditions not intended.

1. The motor speed may be incorrect.
2. The motor speed may be excessive.
3. The direction of rotation may be incorrect.
4. The motor may be energised.

In all situations the user should provide sufficient guarding and/or additional redundant monitoring and safety systems to prevent risk of injury. NOTE: During a power loss event the product will commence a sequenced shut down procedure and the system designer must provide suitable protection for this case.

**MAINTENANCE:** Maintenance and repair should only be performed by competent persons using only the recommended spares (or return to factory for repair). Use of unapproved parts may create a hazard and risk of injury.



**WHEN REPLACING A PRODUCT IT IS ESSENTIAL THAT ALL USER DEFINED PARAMETERS THAT DEFINE THE PRODUCT'S OPERATION ARE CORRECTLY INSTALLED BEFORE RETURNING TO USE. FAILURE TO DO SO MAY CREATE A HAZARD AND RISK OF INJURY.**

**PACKAGING:** The packaging is combustible and if disposed of incorrectly may lead to the generation of lethal toxic fumes.

**WEIGHT:** Consideration should be given to the weight of the product when handling.

**REPAIRS:** Repair reports can only be given if the user makes sufficient and accurate defect reporting.

Remember that the product without the required precautions can represent an electrical hazard and risk of injury, and that rotating machinery is a mechanical hazard.

**PROTECTIVE INSULATION:**

1. All exposed metal insulation is protected by basic insulation and user bonding to earth i.e. Class 1.
2. Earth bonding is the responsibility of the installer.
3. All signal terminals are protected by basic insulation, and the user earth bonding. (Class 1). The purpose of this protection is to allow safe connection to other low voltage equipment and is not designed to allow these terminals to be connected to any un-isolated potential.

**Important note:** It is essential that all the following warnings are read and understood.

## 1.4 Summary of further warnings

This summary is provided for convenience only. Please read the entire manual prior to first time product use.

0V on T13 must be used for protective clean earth connection.

Do not rely on any JL/X function to prevent the motor from operating when personnel are undertaking maintenance, or when machine guards are open. Electronic control is not accepted by safety codes to be the sole means of inhibition of the controller. Always isolate the power source before working on the JL/X or the motor or load.

Contactors usually have a high inductance. When the contactor is de-energised it can produce high energy arcing on the internal JL/X control relay. This may degrade the life of the relay and/or produce excessive EMC emissions. Ensure that the contactor coil is fitted with a snubber. Refer to contactor supplier for details.

The essential elements of controlling the contactor are as follows.

- 1) It must be possible to release the contactor without relying on electronics.
- 2) The contactor must not break current. To obey this rule the following applies:-
  - a) The JL/X must not attempt to deliver stator current until after the contactor has closed.
  - b) The stator current must be brought to zero before the contactor has opened.
- 3) The contactor control circuit must be compatible with all likely application requirements.

It may be necessary for installations to have over-riding external independent systems for de-energising the main contactor. In this case it is recommended that the CSTOP terminal be opened 100mS in advance of the main contacts opening. Failure to achieve this may result in damage to the unit.

Note. If the main contactor has a closing time delay of greater than 75mS, then it is essential that steps are taken to delay the release of stator current until the main contact has closed by inserting an auxiliary normally open contact of the main contactor in series with the RUN input on T31.

All external fuses must be of the correct rating and type. The  $I^2t$  rating must be less than the rating specified in the rating tables. This includes main and auxiliary fuses.

Check the 3 phase auxiliary supply phasing on EL1/2/3 equates to the phasing of the main stack supply on L1/2/3, and the 1 ph control supply on T52/53 is correct.

Disconnect the JL/X for any wiring tests using a high voltage insulation tester.

A protective clean earth connection must be made to the control 0V on T13 to ensure that the installation complies with protective class1 requirements.

The emergency stopping and safety procedure, including local and remote actuators, must be checked prior to applying power to the motor.

All JL/X alarms are generated by semiconductor electronics. Local safety codes may mandate electro-mechanical alarm systems. All alarms must be tested in the final application prior to use. The suppliers and manufacturers of the JL/X are not responsible for system safety.

It is important that 680)alarm BURDEN OHMS, is set as closely as possible to the physical ACCT burden installed on the power board. DO NOT ALLOW THE MODEL RATING TO EXCEED THE VALUES GIVEN IN THE RATING TABLE AND ON THE RATING LABEL FOUND UNDER THE UPPER END CAP. FAILURE TO HEED THIS WARNING WILL INVALIDATE ANY WARRANTY, AND VIOLATE APPROVAL STANDARDS. NO LIABILITY IS ACCEPTED BY THE MANUFACTURER AND/OR DISTRIBUTOR FOR FAULTS CAUSED BY RE-RATING OF THE PRODUCT.

All units must be protected by correctly rated semi-conductor fuses. Failure to do so will invalidate warranty.

IMPORTANT SAFETY WARNINGS			
	The AC supply filters must not be used on supplies that are un-balanced or float with respect to earth	The drive and AC filter must only be used with a permanent earth connection. No plugs/sockets are allowed in the AC supply	The AC supply filter contains high voltage capacitors and should not be touched for a period of 20 seconds after the removal of the AC supply

## 2 Introduction

A slip ring motor is a type of induction motor having a wound rotor connected to slip rings. The stator (U, V, W) is phase angle controlled by the JL/X in a closed loop with speed feedback derived from a tachogenerator or encoder mounted on the motor shaft. Alternatively, pure stator current control may be utilised, with no speed feedback required for this method. The motor speed/torque characteristic may be modified by resistors connected to the rotor slip rings, controlled by JL/X relay output drivers. Four resistor control outputs are provided. Generally, only one or two would be used for applications such as slew, yaw or X/Y travel. Hoist applications might use three or four. Undemanding applications may employ fixed rotor resistance.

Operation at speeds above synchronous speed is detected and under this circumstance rotor resistance is minimised for maximum regeneration into the supply (if maximum speed is demanded by the operator). If speeds above synchronous speed are detected without being demanded by the operator, plugging operation prevails for maximum counter-torque availability.

Provision is made for selection of analogue or joystick controlled speed demand or current demand. The default block diagram is configured for analogue control, a joystick control configuration exists within the 3-key reset page. Analogue outputs representing stator current, stator volts and speed are provided.

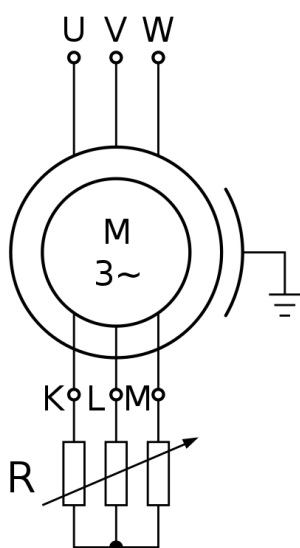

The JL/X range of slip ring motor drives is a derivation of the PL/X digital DC drive product range. It shares the same software and hardware platforms and delivers the same precise digital control functionality enjoyed by users of the established range of DC Drives. The main difference between the JL/X and PL/X range is that the thyristor stack configuration has been designed to provide a firing angle controlled 3 phase output (U, V, W) suitable for controlling slip ring motors in either 2 or 4 Quadrant modes. All the fieldbus options and configuration software packages used with the PL/X are also available for the JL/X range.

The JL/X range covers output currents from 130 to 1650 Amps and is available in 3 frame sizes with standard supply voltage inputs up to 480VAC. (Frame 2, 4 and 5). Frame sizes 4 and 5 also have the option of being supplied as HV units. These units are able to accept AC supply voltages up to 690 VAC for higher voltage applications. The JL/X range has an overload capability of 150% for 25 seconds.

There is also a high duty range called the JL/XHD, having an overload capability of 250% for 25 seconds.

All models have the high current 3 phase supply terminals in standard top entry, with the stator connections at the bottom of the unit.



## 2.1 Operation of Slip Ring Motor

### 2.1.1 Stator Voltage Control

The Speed / Torque curve for a Slip Ring Motor is shown in the diagram below for the case where the Rotor resistors are static.

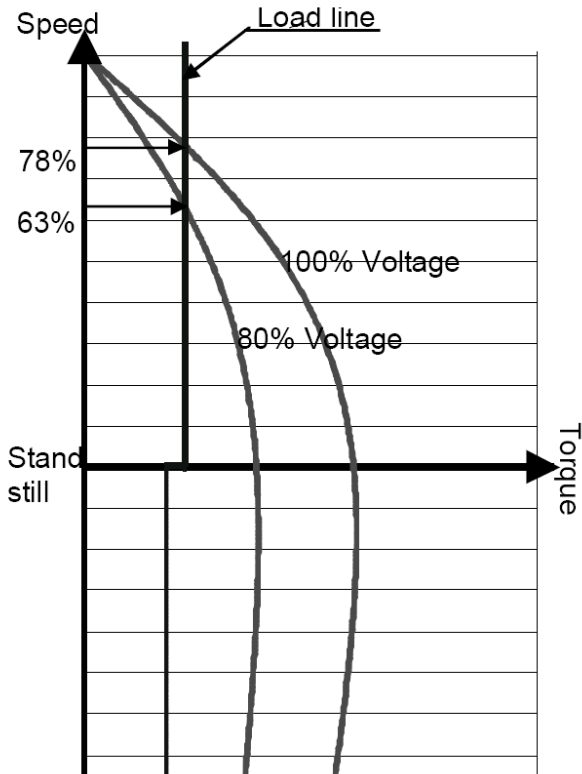

The curved lines represent the Speed / Torque relationship at 100% and 80% Stator voltage.

The voltage on the Stator is controlled by adjusting the phase angle of the 3 phase thyristor stack within the JL/X. This is controlled with reference to the speed setpoint and speed feedback.

In this case it is possible to alter the speed of the motor for a given load, requiring the same torque, by adjusting the Stator voltage.

A reduced Stator voltage will reduce the peak torque by approximately the square of the voltage reduction.

Here a reduction in Stator voltage from 100% to 80% will reduce the speed from 78% to 63%

### 2.1.2 Bi-directional control using the JLX

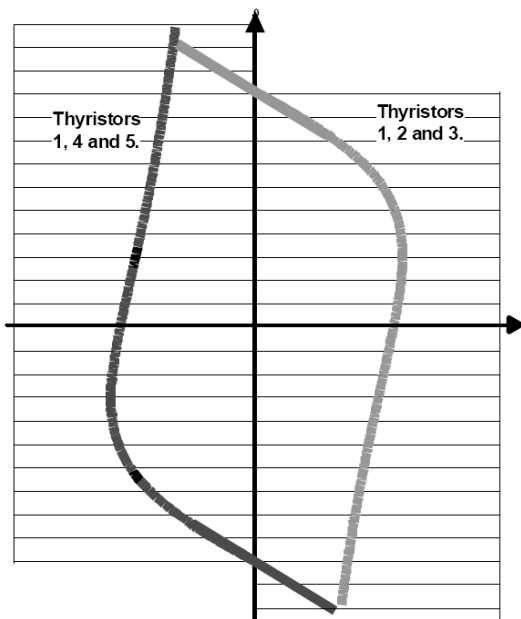

The JL model has a single 3 phase stack with 3 pairs of anti-parallel thyristors which provide a phase controlled 3 phase output driving the stator. Thyristor pairs are 1, 2 and 3

The JLX model has 2 further pairs of anti-parallel thyristors (4 and 5) which allow the direction of the stator phase rotation to be reversed. In this case the stator is driven by thyristor pairs 1, 4 and 5.

This implementation allows all 4 quadrants of speed and torque to be controlled.

### 2.1.3 Rotor Control to optimise torque across speed range

The diagram shows all 4 quadrants of speed against torque, with curves for a shorted rotor and for 4 other values of rotor resistance. This diagram is of course a simplistic representation to facilitate the explanation of the control strategy.

For a high rotor resistance ( $R_1 + R_2 + R_3 + R_4 + R_5$ ) the starting torque is high but the torque at higher speeds reduces.

For a shorted rotor the starting torque is low but the torque at higher speeds increases.

There is a family of curves in between. The JL/X automatically selects the appropriate Rotor resistance using the contactor outputs to keep the torque curve at maximum throughout the speed range.

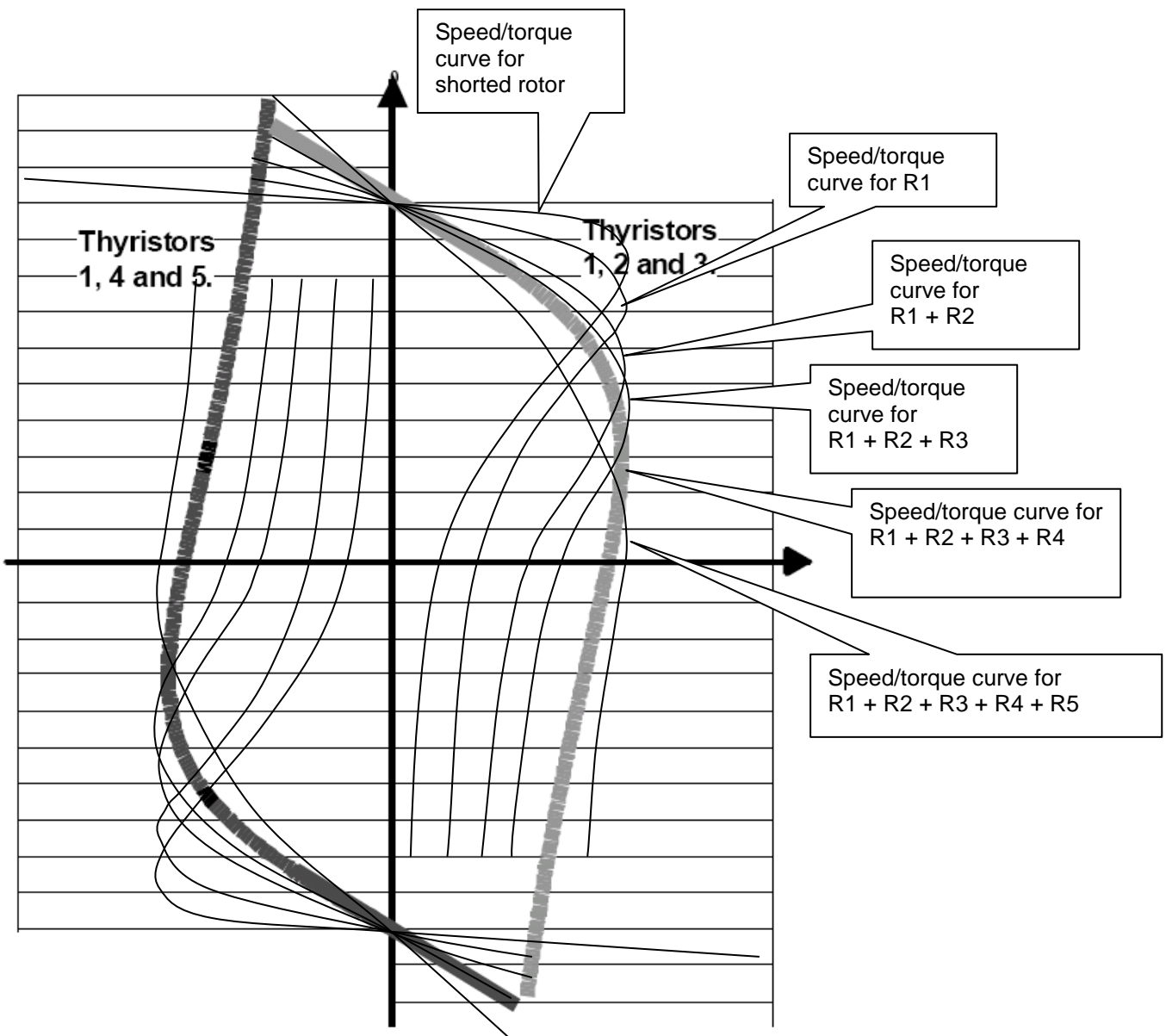

### 2.1.4 Hyper-synchronous regeneration

The shaded areas in the braking quadrants are where regeneration can occur. Outside the shaded areas any braking that occurs is achieved through a process known as plugging in which the absorbed energy is dissipated in the rotor and the rotor resistors. Hence for regeneration to occur the load must be forcing the speed to exceed synchronous speed. The JLY must arrange for the correct loop conditions and thyristor combination to be selected to regenerate the current back into the supply. As the motor approaches the synchronous speed in either of the motoring quadrants, the opposing stator phase rotation is selected to activate the braking quadrant. Simultaneously the speed demand is set above synchronous speed to ensure that the motor speed exceeds the synchronous speed allowing slip to create regenerative current.

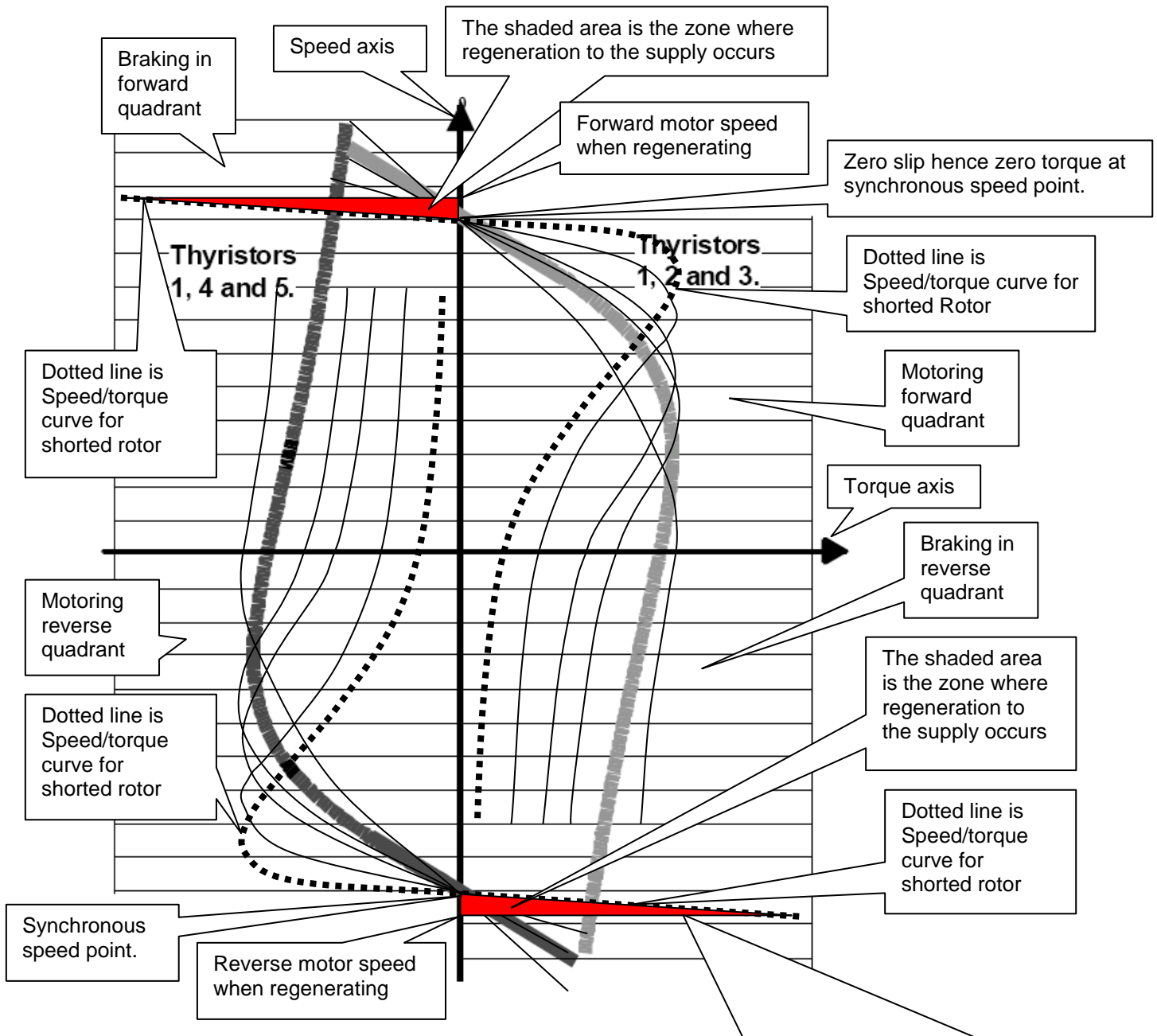

Motor speed is higher than synchronous speed hence regenerative current is created by slip and returned to the supply by the JLY. The braking torque is optimised for the lowest slip by using a shorted rotor. The maximum torque depends primarily on the overload limit of the JLY and also the motor/installation rating. The speed will rise above synchronous speed until the torque reaches a level that satisfies the load. This action is mirrored in the braking forward quadrant under similar conditions.

## 2.2 Notes on configuration and the use of this manual

The JL/X has been developed as a special application based on existing PL/X dc drive hardware and software. The PL/X drive is very versatile, and highly configurable with regards to its internal block diagram connections. In contrast, the JL/X is pre-configured for the most common slip ring motor applications and in the majority of cases block diagram connection changes will not be required. The JL/X also makes extensive use of existing PL/X family application blocks, and most of the available I/O capabilities of the hardware. Therefore this manual does not include references to the methods required for making block diagram configuration changes or the full functionality of the individual applications blocks used, just the individual parameters requiring adjustment.

## 2.3 Notes on the use of the JL/X MMI

Similarly, and dependant on the JL/X software issue, certain parameters available when using the JL/X MMI may be presented using legacy names applicable to the PL/X range of dc drives. In those cases, the parameter names may be ignored – use the parameter identification numbers for identification purposes if required. This manual does not describe the internal menu structure of the JL/X.

Reference can be made to the PL/X family manuals for information on both the above subjects and all manuals are available for download from [www.bardac.com](http://www.bardac.com) if required.

It is strongly suggested that the JL/X should be commissioned using Savvy software rather than via the JL/X MMI or by using Pilot software (except where noted in the commissioning guide below). Savvy software can be downloaded from [www.driveweb.com](http://www.driveweb.com) by using the “get savvy” link, if required.

# 3 Control terminals

## 3.1 Control terminals electrical specifications

The following describes the electrical specification of the control terminals. The default functions for these terminals are described in section 3.2.

### 3.1.1 Universal Inputs (UIP2 – UIP9, terminals 2 to 9)

4 input voltage ranges +/-5/10/20/30V.  
Input impedance 100K for input scaling at 5 and 10V range.  
Input impedance 50K for input scaling above 10V range.

### 3.1.2 Analogue Outputs (AOP1 – AOP3, terminals 10 to 12)

Short circuit protection to 0V.  
Output current +/-5mA maximum.  
Output range 0 to +/-11V.

### 3.1.3 Digital Inputs (DIP1 – DIP4, terminals 14 to 17)

Fixed threshold, logic low <2V, logic high >4V.  
Input impedance 10K Ohms.

DIP3 and DIP4 may also be used for incremental encoder A and B signals, maximum input frequency 100KHz.

#### 3.1.4 Digital Input/Outputs (DIO1 – DIO4, terminals 18 to 21)

Input impedance 10K Ohms.

Short circuit protected with internal flywheel diode. (Range 22 to 32 Volts for output high).

Output capability 350mA, total for all digital outputs 350mA.

#### 3.1.5 Digital Outputs (DOP1 – DOP3, terminals 22 to 24)

Short circuit protected with internal flywheel diode. (Range 22 to 32 Volts for output high).

Output capability 350mA, total for all digital outputs 350mA.

## 3.2 Control terminals default functions

When the JL/X is shipped the control terminals are allocated with the following functions. All the programmable terminals are available to be configured for an alternative function by the user if desired. An alternative joystick control configuration is stored in recipe page 3. To access it a 3-Key reset is required.

Current versions of the product cannot be reset to “as shipped” default configuration. Please contact the supplier if a return to default condition is required.

### 3.2.1 Universal Inputs UIP2 – UIP9 (terminals 2 to 9)

<b>0V terminal</b>		<b>0V</b>	<b>T1</b>
<b>Contactor interlock</b> Used by the default configuration as part of the brake release sequencing	<b>Digital input</b>	<b>UIP2</b>	<b>T2</b>
<b>Current limit</b> 0 to +10V linear input for 0 to 150% stator current limit (0 to +/-250% on HD models).	<b>Analogue input</b>	<b>UIP3</b>	<b>T3</b>
<b>Speed demand</b> 0 to +/-10V linear input for 0 to +/-100% speed.	<b>Analogue input</b>	<b>UIP4</b>	<b>T4</b>
<b>Start positive</b> Used as an alternative START command, setting the polarity of UIP4 to be non-inverting.	<b>Digital input</b>	<b>UIP5</b>	<b>T5</b>
<b>Start negative</b> Used as an alternative START command, setting the polarity of UIP4 to be inverting.	<b>Digital input</b>	<b>UIP6</b>	<b>T6</b>
<b>Spare input</b>	<b>Analogue input</b>	<b>UIP7</b>	<b>T7</b>
<b>Positive hyper-synchronous detection input</b> Link to terminal AOP2 T11 to enable hyper-synchronous speed detection.	<b>Analogue input</b>	<b>UIP8</b>	<b>T8</b>
<b>Negative hyper-synchronous detection input</b> Link to terminal AOP2 T11 to enable hyper-synchronous speed detection.	<b>Analogue input</b>	<b>UIP9</b>	<b>T9</b>

### 3.2.2 Analogue Outputs AOP1 – AOP3 (terminals 10 to 12) and Iarm (terminal 29)

<b>Stator current % monitor</b> 0 to +/-10V linear output for 0 to +/-150% stator current (or 0 to +/-250% on HD models).	<b>Analogue output</b>	<b>AOP1</b>	<b>T10</b>
<b>Speed feedback monitor</b> 0 to +/-10V linear output for 0 to +/-100% speed feedback.	<b>Analogue output</b>	<b>AOP2</b>	<b>T11</b>
<b>Stator voltage % monitor</b> 0 to 10V linear output for 0 to 100% stator r.m.s. volts.	<b>Analogue output</b>	<b>AOP3</b>	<b>T12</b>

### 3.2.3 Digital Inputs DIP1 – DIP4 (terminals 14 to 17)

<b>0V</b> Connect to clean earth star point.		<b>0V</b>	<b>T13</b>
<b>Spare input</b>	<b>Logic low below 2V, high above 4V</b>	<b>Digital input</b>	<b>DIP1 T14</b>
<b>Spare input</b>	<b>Logic low below 2V, high above 4V</b>	<b>Digital input</b>	<b>DIP2 T15</b>
<b>Encoder (B train or sign)</b>	<b>Logic low below 2V, high above 4V</b>	<b>Digital input</b>	<b>DIP3 T16</b>
<b>Encoder (A train)</b>	<b>Logic low below 2V, high above 4V</b>	<b>Digital input</b>	<b>DIP4 T17</b>

### 3.2.4 Digital Input/Outputs DIO1 – DIO4 (terminals 18 to 21)

<b>Rotor resistor control</b> Output high to control highest rotor resistor shorting contactor.	<b>Digital output</b>	<b>DIO1</b>	<b>T18</b>
<b>Rotor resistor control</b> Output high to control second highest rotor resistor shorting contactor.	<b>Digital output</b>	<b>DIO2</b>	<b>T19</b>
<b>Rotor resistor control</b> Output high to control third highest rotor resistor shorting contactor	<b>Digital output</b>	<b>DIO3</b>	<b>T20</b>
<b>Rotor resistor control</b> Output high to control lowest rotor resistor shorting contactor.	<b>Digital output</b>	<b>DIO4</b>	<b>T21</b>

### 3.2.5 Digital Outputs DOP1 – DOP3 (terminals 22 to 24)

<b>Brake engage</b> Output low to demand brake engage when stopping – rotor speed threshold activated.	<b>Digital output</b>	<b>DOP1</b>	<b>T22</b>
<b>Brake release</b> Output high to authorise brake release when starting – stator current threshold activated.	<b>Digital output</b>	<b>DOP2</b>	<b>T23</b>
<b>Drive healthy</b> Output high when the controller is healthy.	<b>Digital output</b>	<b>DOP3</b>	<b>T24</b>

## 3.3 Non-programmable terminals (terminals 25 to 53)

### 3.3.1 Control board terminals

<b>Analogue 0V</b>	<b>A0V</b>	<b>T25</b>
<b>Analogue tacho input</b> +/- 200V range, input impedance 150K Ohms	<b>TACHOT26</b>	
<b>+10V reference output</b> +10.00V +/-0.5%, 10mA max. Short circuit protection to A0V	<b>+10</b>	<b>T27</b>
<b>-10V reference output</b> -10.00V +/-0.5%, 10mA max. Short circuit protection to A0V	<b>-10</b>	<b>T28</b>
<b>Stator current metering output</b> +/-5V +/-5% linear output for +/-100% model rating stator current Programmable uni-polar or bi-polar output Output current capability 10mA. Short circuit protection to A0V	<b>Iarm</b>	<b>T29</b>
<b>Thermistor input</b> Motor temperature thermistor or thermal switch OK<200 Ohms, Over-temperature >2K Ohms. Connect between THERM and A0V	<b>THERMT30</b>	
<b>Run input</b> Electronic enable for current loop and contactor drop out delays 24V logic input, logic low <6V, logic high >16V Input impedance. 10K Ohms	<b>RUN</b>	<b>T31</b>
<b>Brake fail assist input</b>	<b>JOG</b>	<b>T32</b>

Jog input with programmable contactor drop out delay  
24V logic input, logic low <6V, logic high >16V  
Input impedance. 10K Ohms

**Start input**

Start input with programmable contactor drop out delay.  
24V logic input, logic low <6V, logic high >16V.  
Input impedance 10K Ohms.

**START T33**

**Coast stop input**

Coast stop input.  
24V logic input, logic low <6V, logic high >16V.  
Input impedance 10K Ohms.

**CSTOP T34**

**+24V**

Nominal +24V output for external logic, range 22 to 34 volts.  
Short circuit protected.  
Shares total current capability of 'Digital Outputs' (350mA), with additional 50mA capability.  
Total maximum available 400mA.

**+24 T35**

**WARNING. Do not rely on any JL/X function to prevent the motor from operating when personnel are undertaking maintenance, or when machine guards are open. Electronic control is not accepted by safety codes to be the sole means of inhibition of the controller. Always isolate the power source before working on the JL/X or the motor or load. If the RUN input goes low at any point during the stopping process then the contactor will drop out straight away.**

3.3.2 Power board terminals

**RA+**

Do not connect to this terminal.

**RA+ T41**

**NC**

Do not connect to this terminal.

**NC T42**

**RA-**

Do not connect to this terminal.

**RA- T43**

**NC**

Do not connect to this terminal.

**NC T44**

**CON1**

Rating up to 240V 500VA.  
Volt free contact for controlling main supply contactor coil.

**CON1 T45**

**CON2**

Rating up to 240V 500VA.  
Volt free contact for controlling main supply contactor coil

**CON2 T46**

**LATCH1**

Connect to UIP2, terminal 2

**LATCH1 T47**

**LATCH2**

Connect to 24V, terminal 35

**LATCH2 T48**

**E**

Dirty earth connection for control supply

**E T51**

**N**

Control supply neutral connection

**N T52**



100-240VAC, 50/60Hz +/-10% 50VA

L

Control supply line connection  
100-240V 50/60Hz +/-10% 50VA

L T53

## 4 Rating Tables

### 4.1 Rating Table for JL/X standard duty versions

**These models have a 150% overload capability for 25 seconds**

Nominal maximum continuous ratings

Model	KW at 415V AC	HP at 415V AC	HP at 480V AC	HP at 690V AC (HV models)	100% Output Current	Cooling air flow and dissipation		Dimensions mm  W x H x D
						cfm	watts	
JL/X130	75	100	115	N/A	130	365	380	216 x 378 x 218
JL/X170	100	130	150	N/A	170	365	500	216 x 378 x 218
JL/X220	130	170	200	N/A	220	365	650	216 x 378 x 218
JL/X270	160	210	240	N/A	270	365	875	216 x 378 x 218
JL/X370	215	290	335	480	370	400	1200	253 x 700 x 350
JL/X450	260	350	405	580	450	400	1450	253 x 700 x 350
JL/X530	310	415	480	690	530	400	1700	253 x 700 x 350
JL/X615	360	480	555	800	615	400	2000	253 x 700 x 350
JL/X700	405	550	630	915	700	400	2300	253 x 700 x 350
JL/X780	450	610	705	1015	780	400	2500	253 x 700 x 350
JL/X860	500	670	775	1115	860	800	2700	506 x 700 x 350
JL/X1025	595	800	925	1330	1025	800	3200	506 x 700 x 350
JL/X1190	690	930	1075	1550	1190	800	3700	506 x 700 x 350
JL/X1350	785	1055	1220	1755	1350	800	4200	506 x 700 x 350
JL/X1520	880	1190	1375	1980	1520	800	4700	506 x 700 x 350
JL/X1680	975	1310	1515	2180	1680	800	5200	506 x 700 x 350

## 4.2 Rating Table for JL/XHD high duty versions

**These models have a 250% overload capability for 25 seconds**

Nominal maximum continuous shaft ratings

Model	KW at 415V AC	HP at 415V AC	HP at 480V AC	HP 690V AC (HV models)	100% Output Current	Cooling air flow and dissipation		Dimensions mm  W x H x D
						cfm	watts	
JL/XHD75	45	60	70	N/A	75	365	380	216 x 378 x 218
JL/XHD100	60	80	90	N/A	100	365	500	216 x 378 x 218
JL/XHD130	75	100	115	N/A	130	365	650	216 x 378 x 218
JL/XHD160	95	125	145	N/A	160	365	875	216 x 378 x 218
JL/XHD220	130	170	200	280	220	400	1200	253 x 700 x 350
JL/XHD270	160	210	240	350	270	400	1450	253 x 700 x 350
JL/XHD320	190	250	290	415	320	400	1700	253 x 700 x 350
JL/XHD370	215	290	335	480	370	400	2000	253 x 700 x 350
JL/XHD420	245	330	380	550	420	400	2300	253 x 700 x 350
JL/XHD470	270	370	430	615	470	400	2500	253 x 700 x 350
JL/XHD520	300	405	470	670	520	800	2700	506 x 700 x 350
JL/XHD615	360	480	555	800	615	800	3200	506 x 700 x 350
JL/XHD715	415	560	650	930	715	800	3700	506 x 700 x 350
JL/XHD815	475	640	740	1065	815	800	4200	506 x 700 x 350
JL/XHD910	530	710	820	1180	910	800	4700	506 x 700 x 350
JL/XHD1010	585	790	915	1310	1010	800	5200	506 x 700 x 350

365 cubic feet per minute is approximately equivalent to 11 cubic metres per minute.

400 cubic feet per minute is approximately equivalent to 12 cubic metres per minute.

800 cubic feet per minute is approximately equivalent to 24 cubic metres per minute.

### Standard Models

Main 3 phase supply 50 - 60hz

Auxiliary 3 phase supply 50 - 60hz

Control 1 phase (50VA) 50 - 60Hz

Any supply from 12 to 480V AC +/- 10%

Any supply from 100 to 480V AC +/- 10%

Any supply from 110 to 240V AC +/- 10%

### High Voltage (HV) Models

Main 3 phase supply 50 - 60hz

Auxiliary 3 phase supply 50 - 60hz

Control 1 phase (50VA) 50 - 60Hz

Any supply from 12 to 690V AC +/- 10%

Any supply from 100 to 690V AC +/- 10%

Any supply from 110 to 240V AC +/- 10%

### Internal Fan supply

JL/X 370/450/530/615/700/780/860 models also need a separate 100VA 240V 50/60Hz ac fan supply.

JL/X 860/1025/1190/1350/1520/1680 models need a 200VA 240V 50/60Hz ac fan supply.

### OUTPUT VOLTAGE RANGE

U, V, W 0 to 1.0 times AC supply.

### OUTPUT CURRENT RANGE

Standard models 0 to 100% continuous, 150% for 25 seconds

HD models 0 to 100% continuous, 250% for 25 seconds

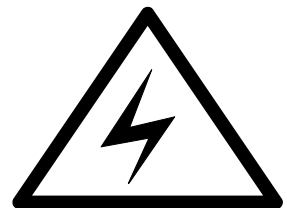

### 4.3 Environment ratings

- Temperature: 0 – 40°C ambient enclosure internal operating temperature  
(0 – 35°C for JL/X1680 and JL/XHD1010)  
-25 °C - +55°C storage  
Protect from direct sunlight  
Ensure dry, corrosive free environment  
85% relative humidity maximum  
Non-flammable, non-condensing  
Pollution degree: 2  
Installation category: 3
- Short circuit-rating: Suitable for use on a circuit capable of delivering not more than  
18000A (JL/X130 – 270 and JL/XHD75 – 160),  
42000A (JL/X370 – 780 and JL/XHD220 – 470),  
85000A (JL/X860 – 1680 and JL/XHD520 – 1010),  
85000A (JL/X370HV – 780HV and JL/XHD220HV – 470HV),  
100000A (JL/X860HV – 1680HV and JL/XHD520HV – 1010HV)  
RMS symmetrical amperes when protected by Ar class fuses.

## 5 Basic wiring diagrams

Please note: The following diagrams indicate the simplest possible configurations, utilise functions found in the default block diagrams and are thus not exhaustive. Alternative control strategies are possible as the JL/X is fully configurable.

### 5.1 Basic power control diagram

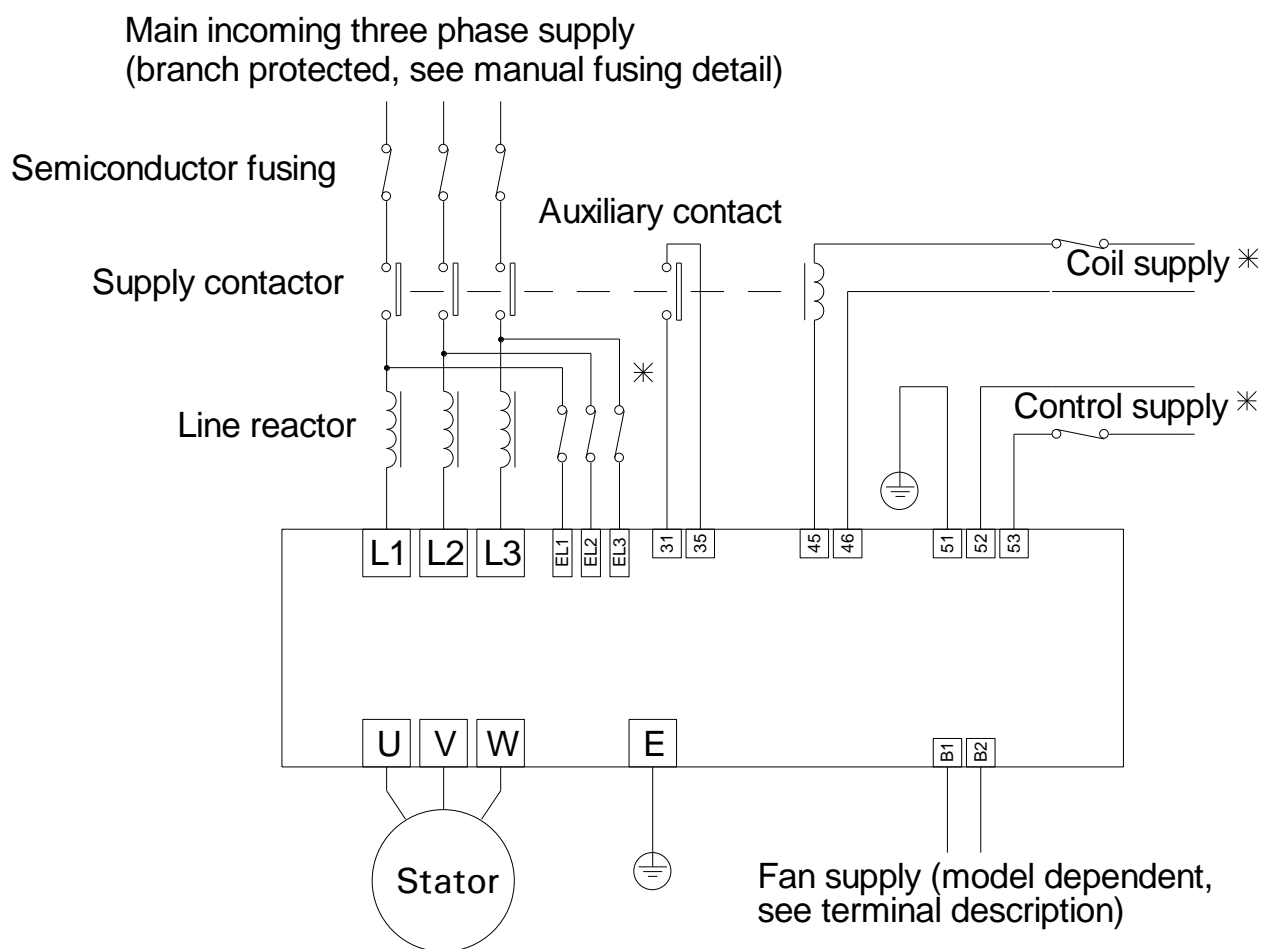

\* Note: EL1,2,3 terminal wiring, control supply and coil supply breaker or HRC fuse protected

5.2 Basic analogue bipolar input speed control (as shipped, default configuration)

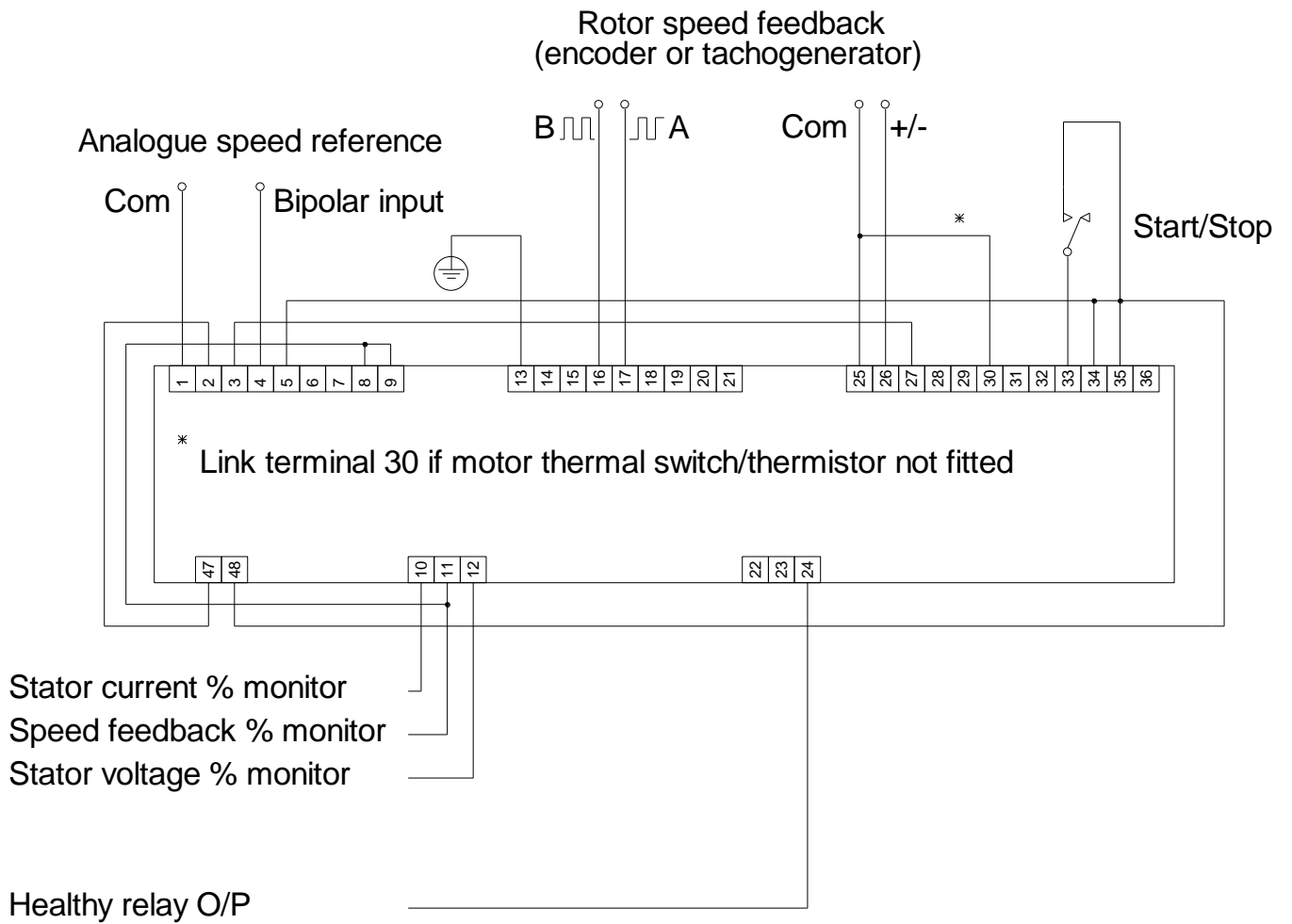

### 5.3 Basic analogue unipolar input speed control (as shipped, default configuration)

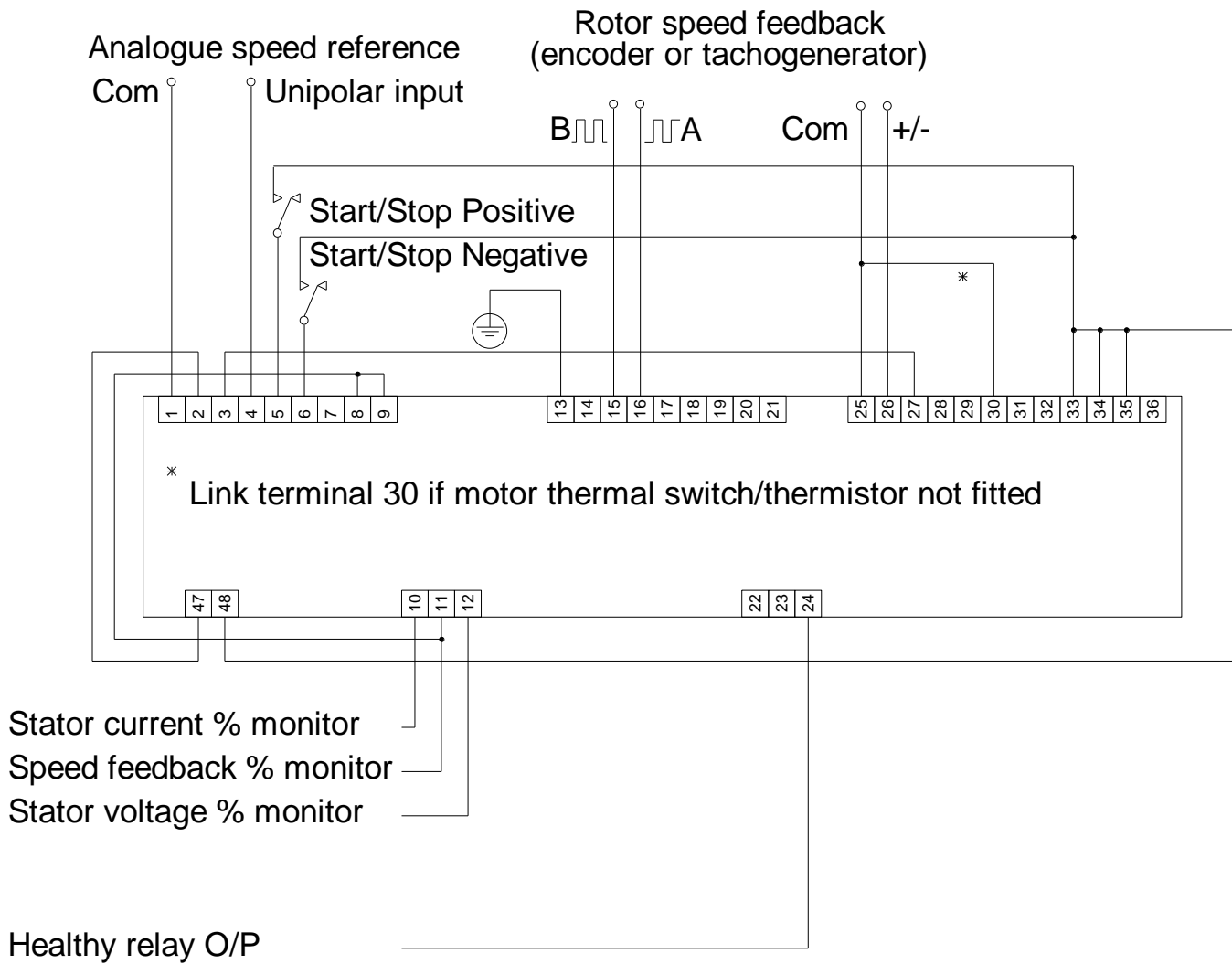

5.4 Basic joystick/digital input speed control (3-key reset configuration).

*Not yet implemented – drawing to follow*

## 5.5 Basic analogue unipolar input current control (as shipped, default configuration)

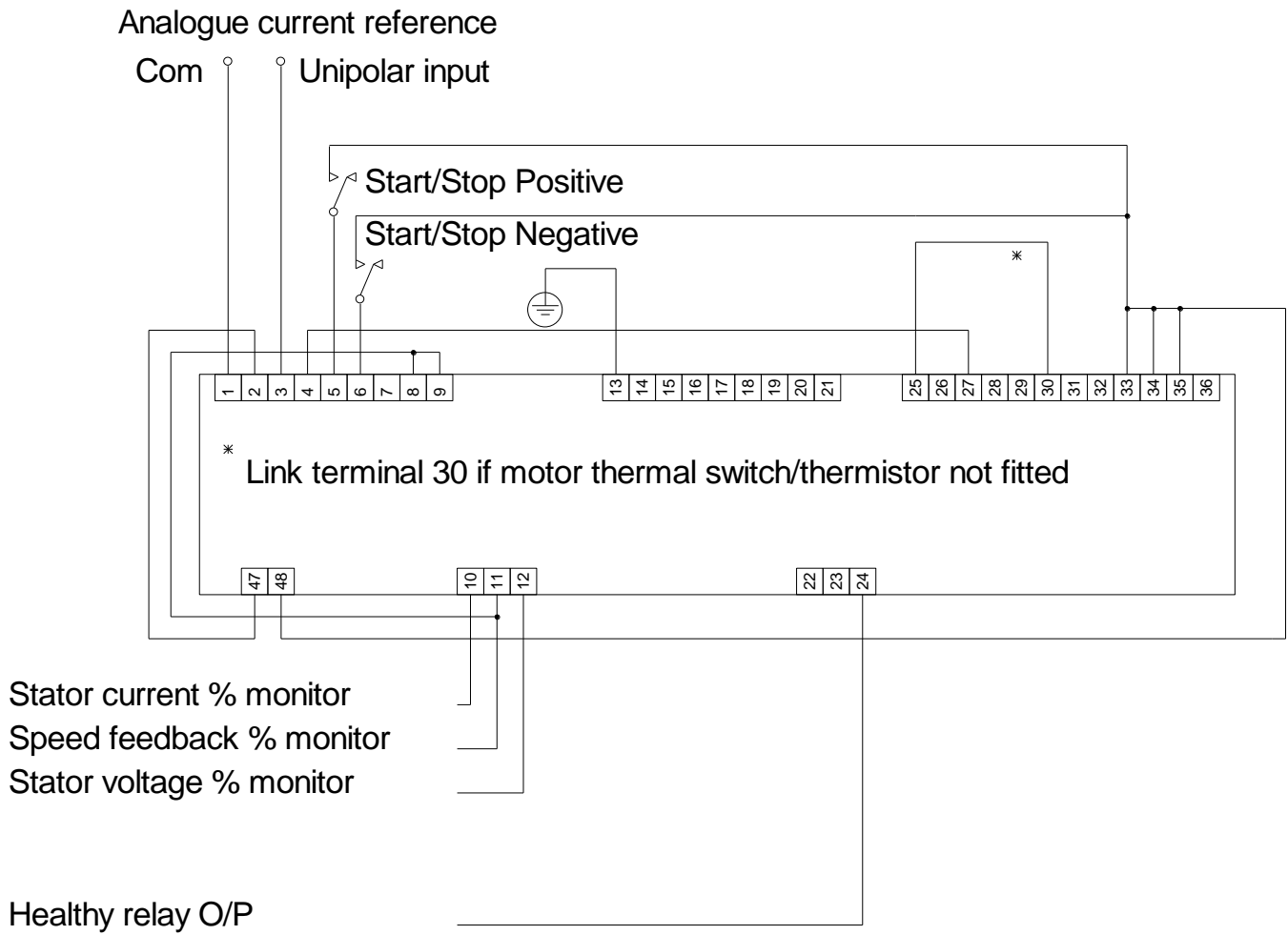



5.6 Basic joystick/digital input current control (3-key reset configuration).

*Not yet implemented – drawing to follow*

## 5.7 Rotor resistance control

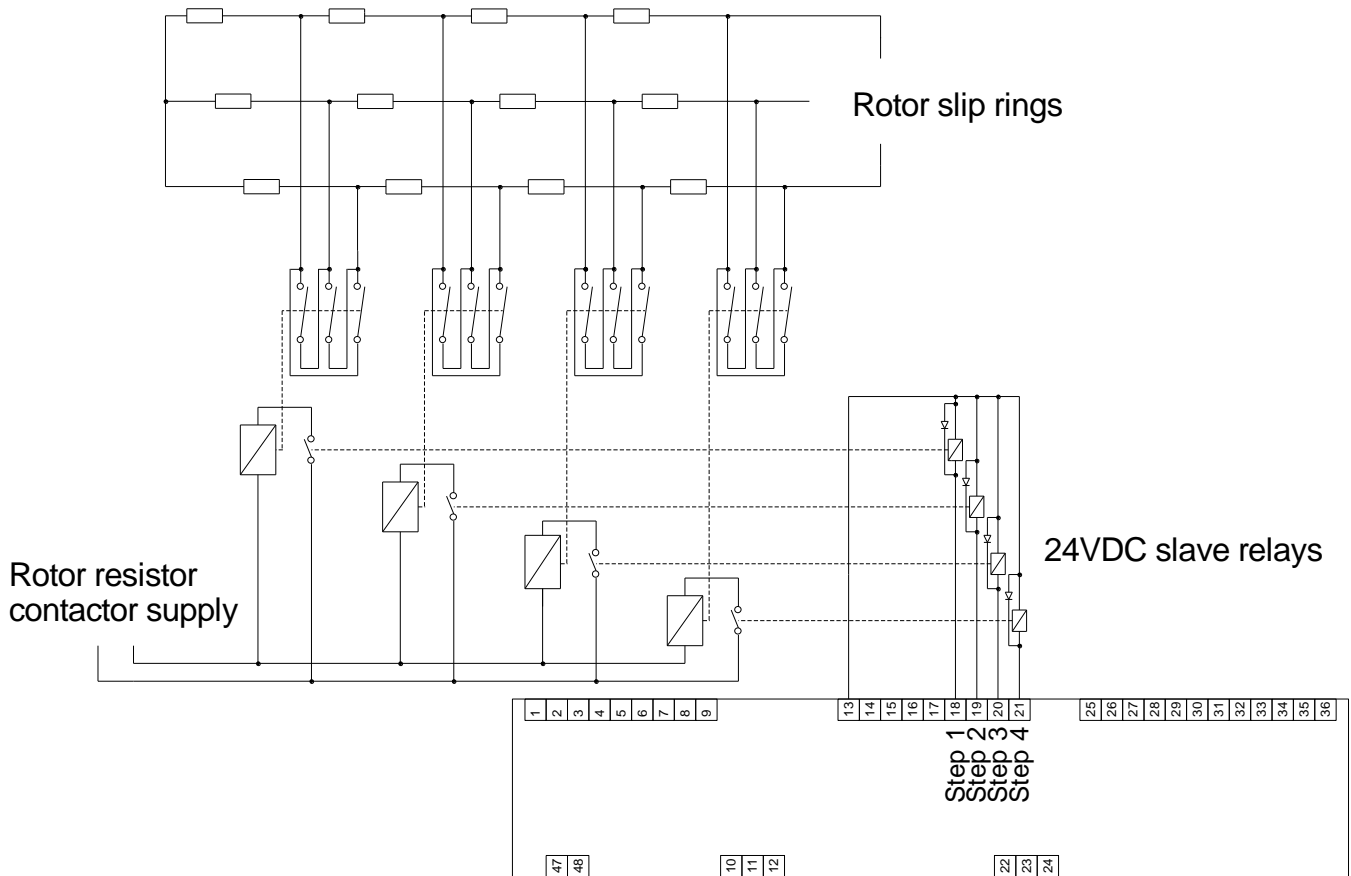

## 5.8 Brake control

Brake supply incoming

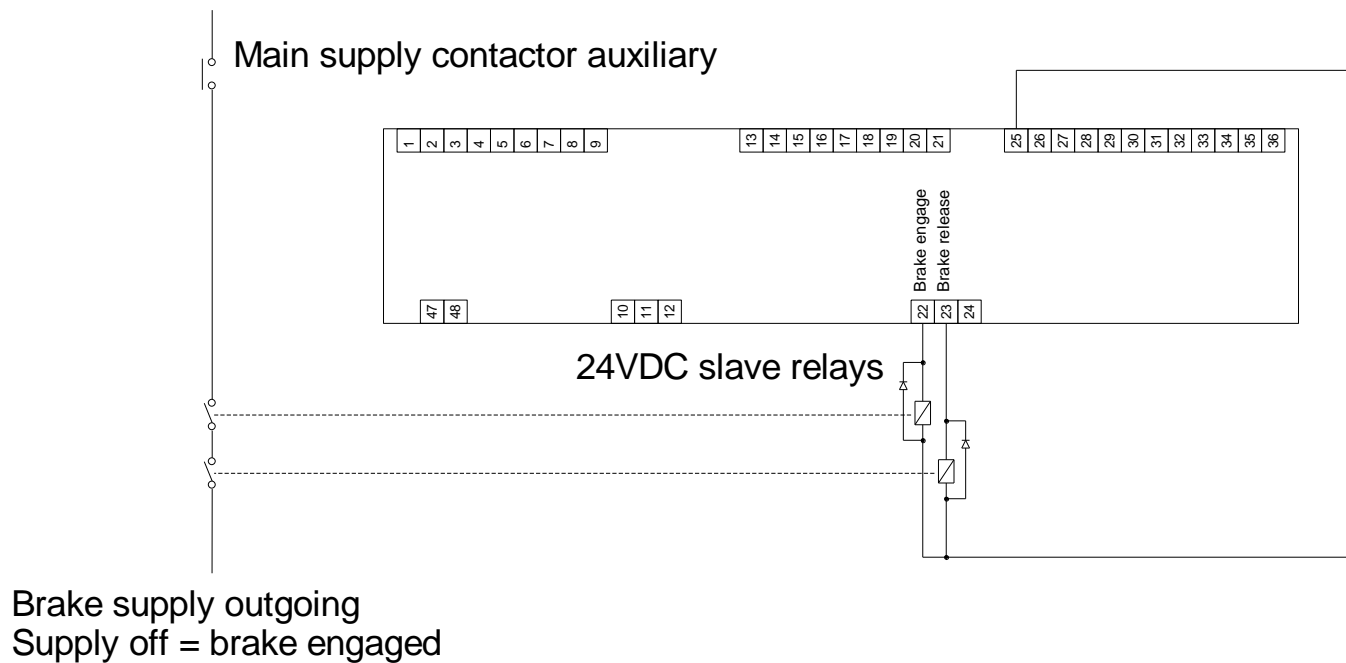

## 6 Commissioning guide

### 6.1 Setting up communications with Savvy software

The JL/X may of course be configured directly from the MMI, or by using Pilot, the free of charge configuration and diagnostic tool supplied by Sprint Electric. Please refer to the generic PL/X family manuals for further details. However, configuration is made very much easier by using Savvy software as it is possible to have a graphical display of the block diagram structure. The following instructions assume the use of Savvy software.

The JL/X may be supplied with an internally fitted drive.web card, offering Ethernet connectivity and Internet access, please refer to supplier. However standard JL/X units are not fitted with this card and must be communicated with using the serial port. The instructions that follow give the procedure needed for both options.

#### 6.1.1 JL/X not fitted with drive.web board

If the JL/X is not fitted with a drive.web board, it will be necessary to communicate with the JL/X using “Discover on Serial Port”, as below, with the JL/X connected to the computer using a standard JL/X to host lead part number LA102595 and (if necessary) an appropriate USB – serial convertor.

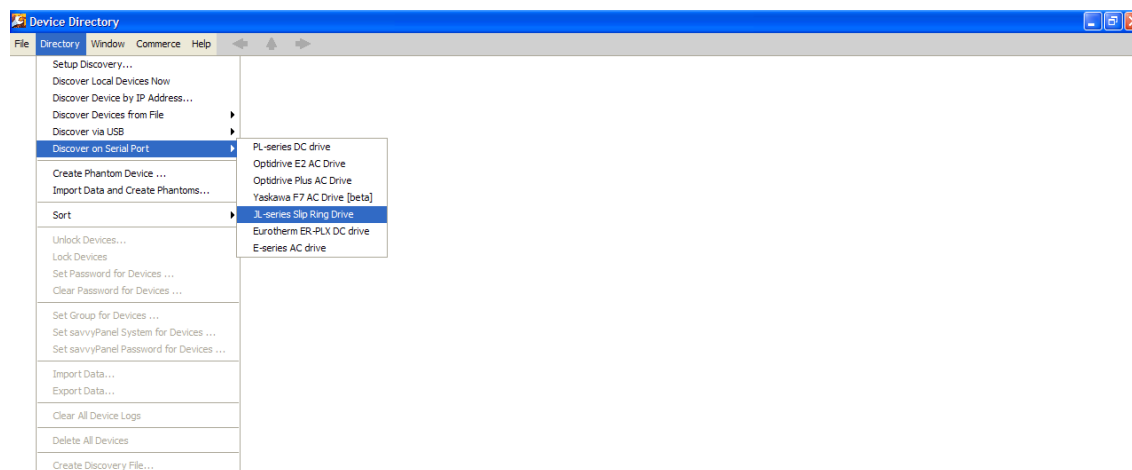

The following box will open:

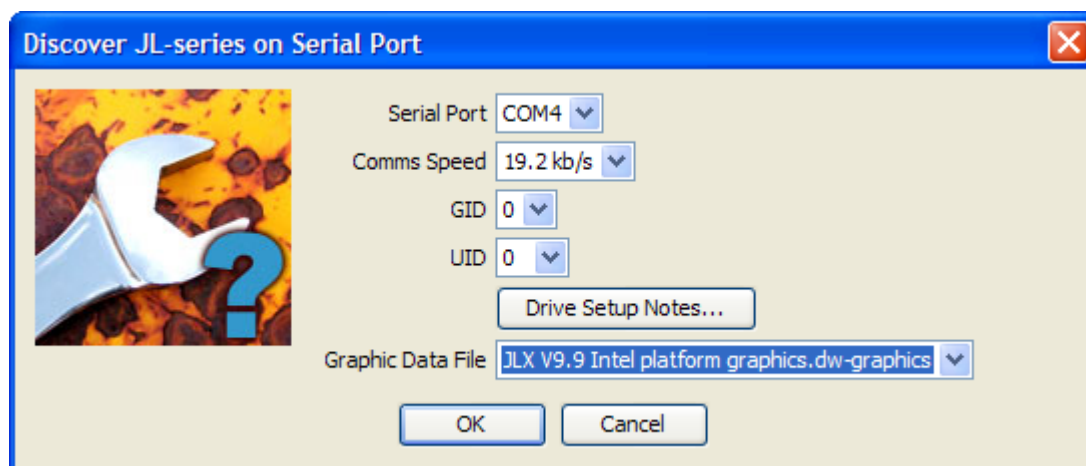

This screen allows you to set the computer serial port in use and baud rate if necessary, and you have the option of selecting the Graphic Data File. (Requires SFD enabled Savvy version). By default the JL/X has its serial port set to ASCII COMMS and a BAUD RATE of 19200. If your computer is using a different baud rate you may set 187)PORT1 BAUD RATE via the JL/X MMI to suit.

The JL/X now appears on the Savvy window – click on it and the first page of the default block diagram should appear.

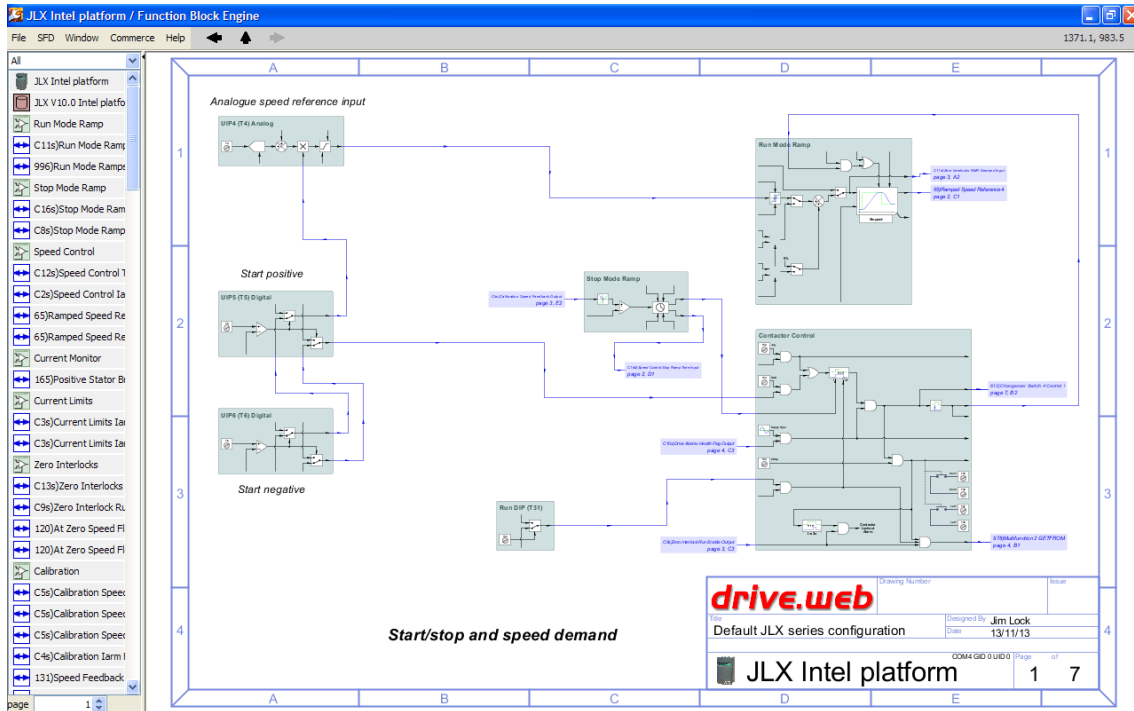

You can navigate up and down through the block diagram pages with the “page” arrows bottom left hand side of the page. You can also use your computer keyboard “page up” and “page down” keys.

When using a serial connection to Savvy, certain commissioning parameters are not adjustable directly from Savvy (at the current Savvy version, V3.5 build 269 or earlier). The procedures that follow describe an alternative method for adjusting the parameters using the JL/X MMI.

### 6.1.2 JL/X fitted with drive.web board

If the JL/X is fitted with a drive.web board, it may be necessary to assign an IP address to the device. All drive.web boards ship with the same IP address, 10.189.189.189. Dynamic IP address assignation is not supported. In order to assign an IP address to fit within your network, proceed as follows: Ensure you have “Capability” set to “Administrate” (this may require a password, if one has previously been set up within Savvy). Then on the Savvy Device Directory screen, select File, Administrate, Set Device IP Address.

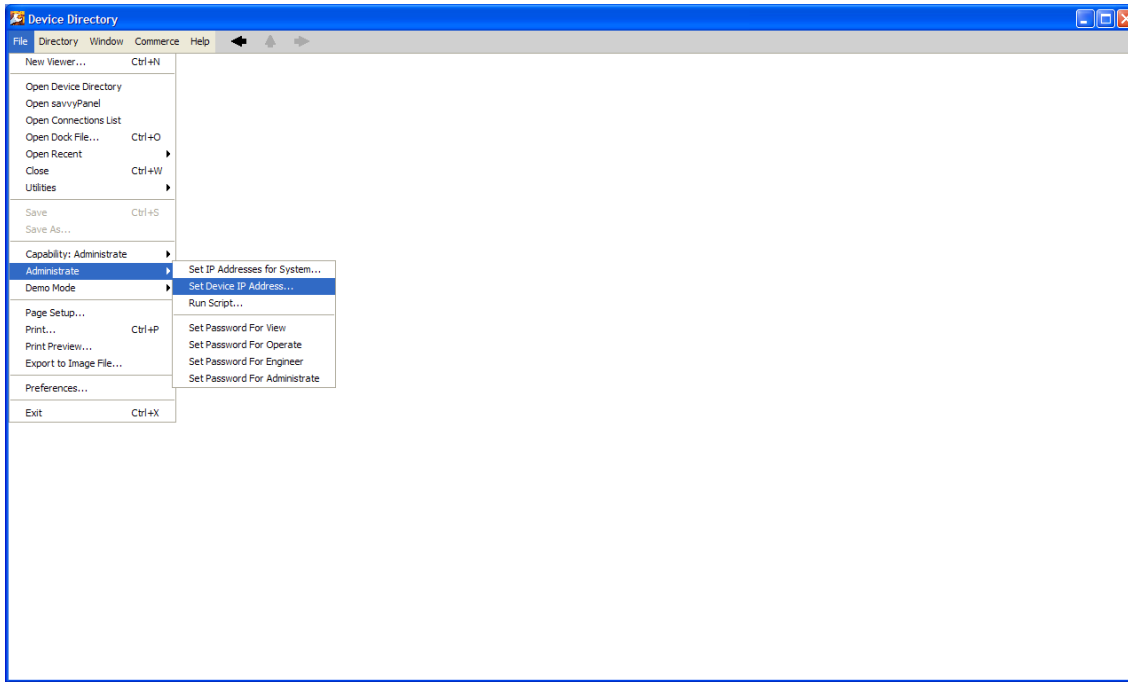

A box opens allowing you to complete the device MAC address and enter the desired IP address.  
**Important note:** Duplicating IP addresses within your network will cause system malfunction. Please ensure a unique IP address is used – refer to the Savvy “Help” files and drive.web manual for further information.

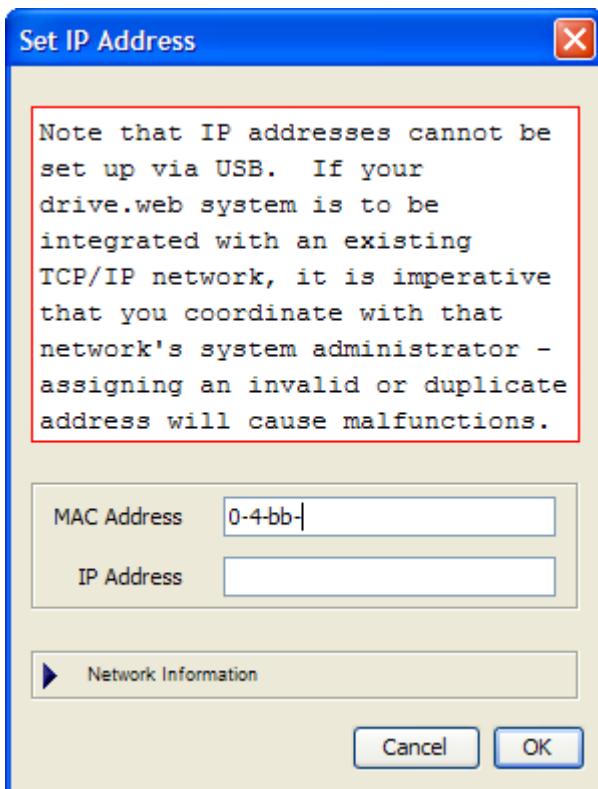

(The device MAC address is found on the drive.web Ethernet connector).

Once complete, use the “Discover Local Devices Now” function.

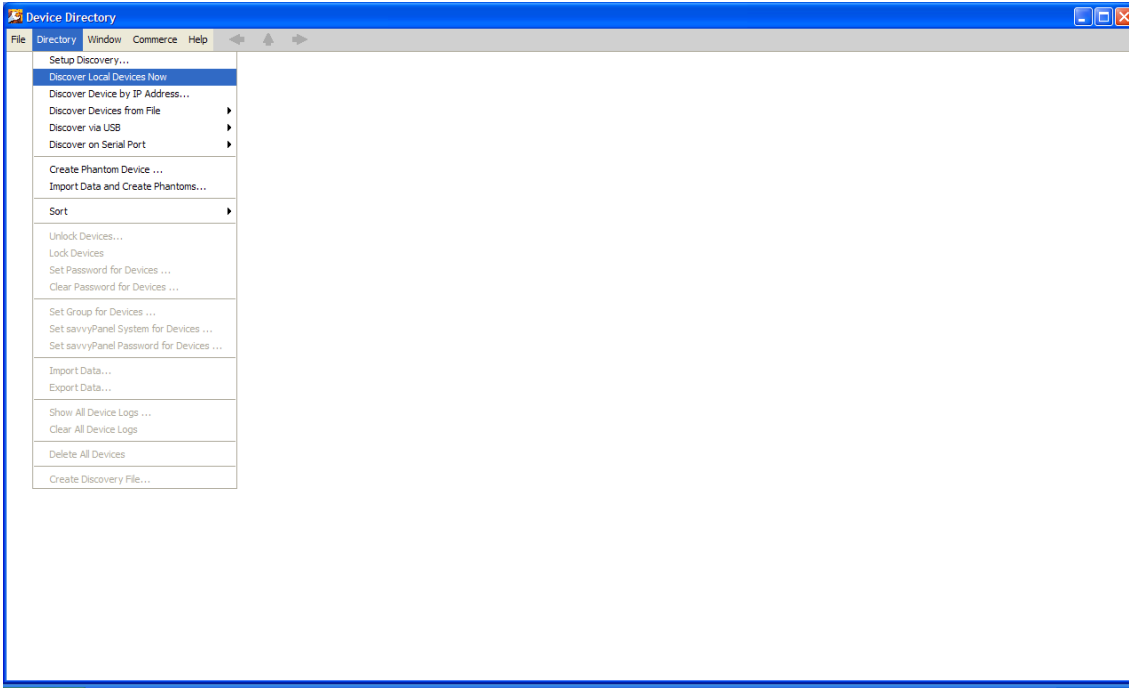

The JLX now appears on the Savvy window – left click on it and the first page of the default block diagram should appear (requires SFD enabled Savvy version), if the drive.web card was factory fitted. If the default block diagram does not appear (perhaps because the drive.web card was retrofitted by a third party) please contact the factory for further guidance.

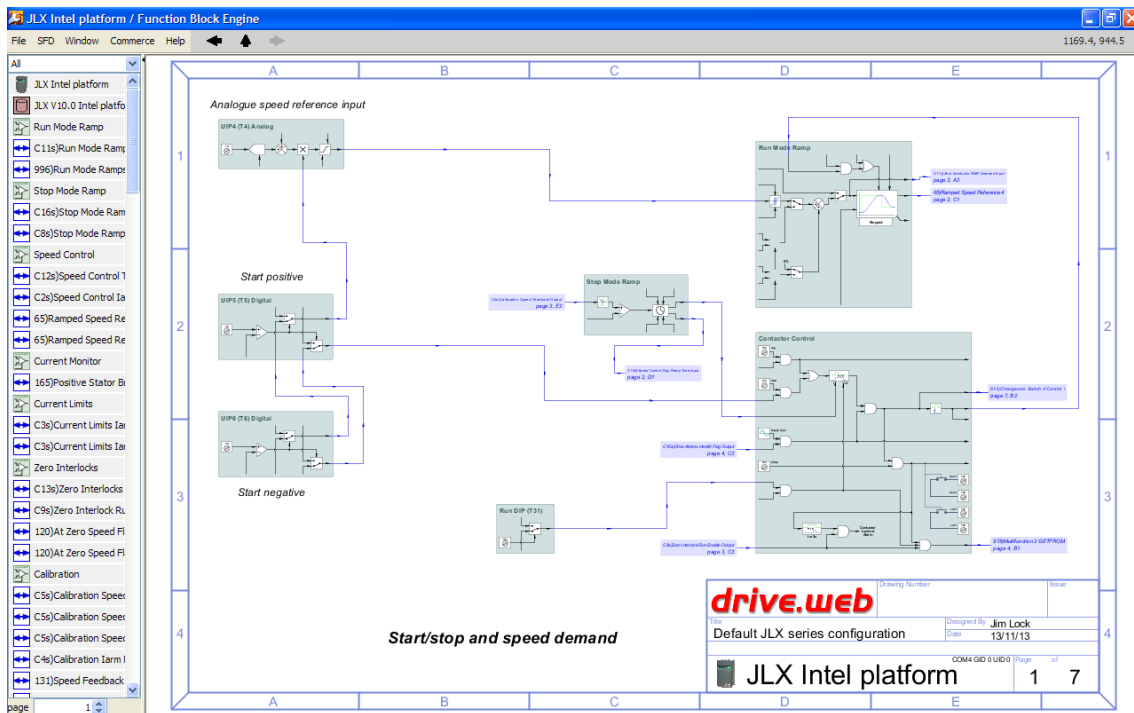

You can navigate up and down through the block diagram pages with the “page” arrows bottom left hand side of the page. You can also use your computer keyboard “page up” and “page down” keys.

Using the drive.web card connection method has the advantage that certain commissioning parameters not available when using a serial connection will be directly modifiable from Savvy. This card also allows Internet access via Ethernet TCP/IP as standard.

## 6.2 Basic calibration

Navigate to the page containing the Calibration block,

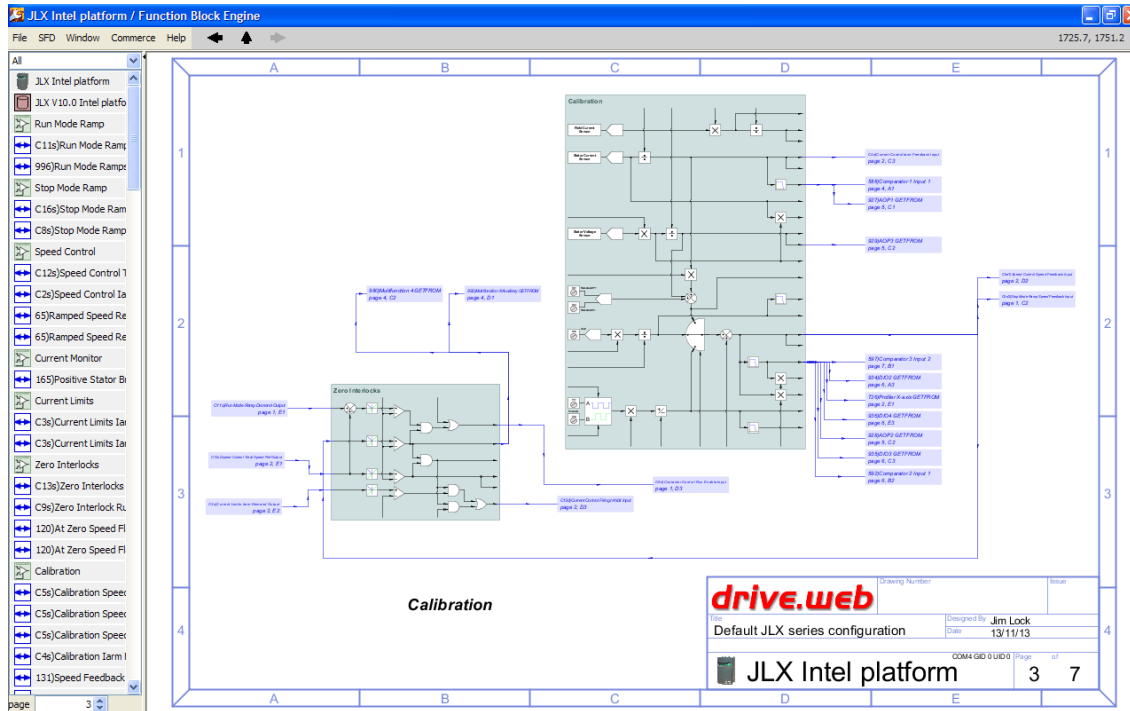

and left click on the Calibration block which then appears as below.

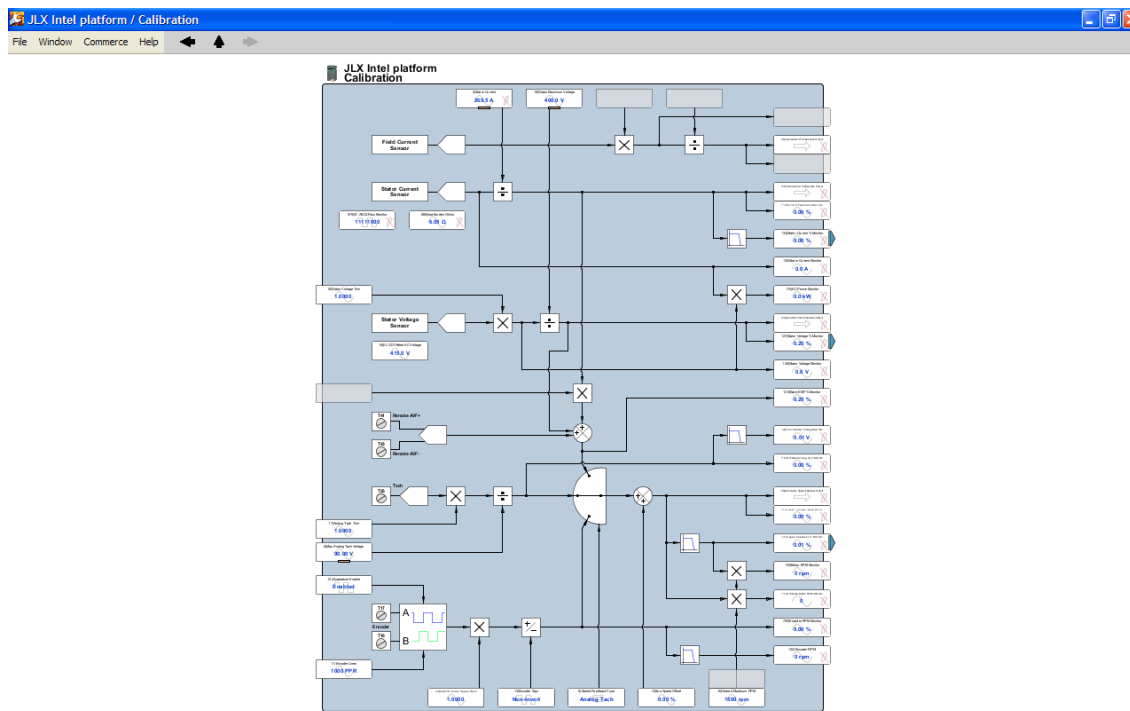

Parameter 3)Current Limit should normally be set to 150%, allowing 150% (for 25 seconds).

Parameter 2)Stator Current should be set to the motor nameplate rated stator current for standard JL/X units. For HD units, a different setting applies. This is because the JL/X currently (V1.23 software) has only a 150% overload capability, HD units are de-rated in order to allow 250% overloads. First decide on the desired overload – for example, if a 200% overload is required on an 83A nameplate rated stator current, this equates to a 166A overload current. The setting of 2)Stator Current is therefore  $(166 * 100)/150 = 110A$ .



The JL/X has a 3/1 turn down ratio available for parameter 2)Stator Current. For example, the JL/X270 allows 2)Stator Current to be set in the range 90.0 to 270.0A. If it is not possible to set this parameter low enough, see later section 6.2.2 Special technique for reducing JL/X current rating.

Parameter 6)Desired Maximum RPM is set to the nominal speed when hyper-synchronous as follows: First calculate the theoretical synchronous speed from  $120F/P$  where F is the supply frequency and P the number of poles. The rated speed will be given on the motor nameplate – subtract this from the theoretical synchronous speed to find the slip. Add the slip to the synchronous speed and set 6)Desired Maximum RPM to this value. For example, an eight pole machine on a 60Hz supply would have a theoretical synchronous speed of 900rpm. The motor nameplate may give a rated speed of 882rpm, therefore 6)Desired Maximum RPM is set to  $900 + 18 = 918$ rpm. This method of setting is used to ensure that the JL/X has a degree of speed control loop overhead when operating hyper-synchronously.

Parameter 8)Max Analog Tach Voltage is set according to the setting of 6)Desired Maximum RPM and the tach specification. Taking the above calculation with a 60V/1000 tach for example, a setting of 55.08V would be required. The value set here is the voltage expected at the tach input terminals 25, 26. There is a limitation of 200VDC on these terminals. For terminal voltages higher than that value please see section 6.2.1 Special technique for high voltage tachogenerators.

Parameter 9)Speed Feedback Type is set to either Analog Tach or Encoder, depending on which feedback type is in use. The example above assumes a tach is in use. If encoder is chosen, it may also be necessary to adjust 10)QUADRATURE ENABLE, 11)ENCODER LINES and 12)MOTOR/ENCODER SPEED RATIO.

Parameter 18)STATOR MAXIMUM VOLTAGE set to the nameplate rated stator voltage.

Parameter 19)EL1/2/3/ Rated AC Voltage is set to the rated supply voltage being presented to EL1/2/3 (usually the same as the supply on L1/2/3).

### 6.2.1 Special technique for high voltage tachogenerators

For tachogenerator volts which exceed 200V full scale, it is necessary to provide an external resistor dropper network as follows.

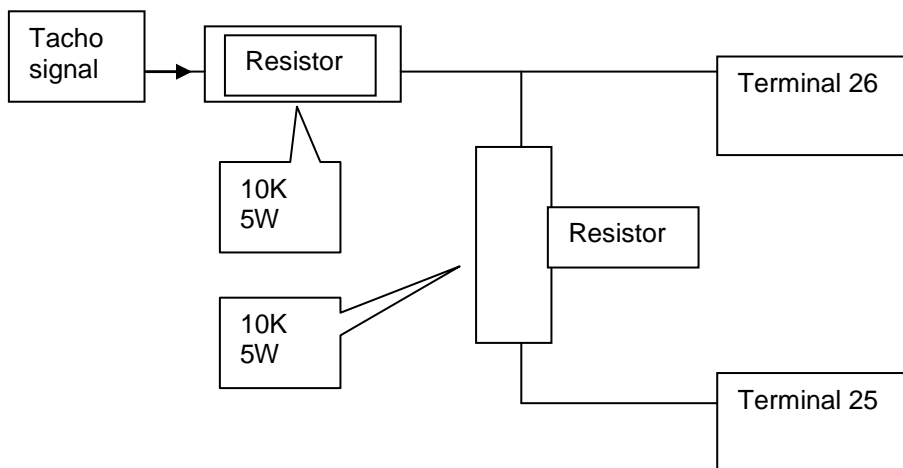

The example network shown will allow full speed voltages up to 400VDC whilst restricting the input terminal to 200VDC. The required setting for 8)Max Analog Tach Voltage is that at terminals 25, 26 at full speed. Appropriate measures must be taken to dissipate the heat from the dropper resistors. The total power in watts dissipated will be  $(\text{Tacho signal volts})^2 / 20,000$  in the example shown.

### 6.2.2 Special technique for reducing JL/X current rating

The JL/X has a 3/1 turn down available for the setting of 2)Rated Stator Amps. If a setting below the minimum available is required, the JL/X has the facility to be rescaled by adjusting the position of the 50/100% jumper found on the lower edge of the power board. This jumper is located to the left of terminals 51, 52, 53 in the case of the frame 2 JL/X130 – 270 and JL/XHD 75 – 160, and just above terminals 51, 52, 53 in the case of the frame 4 and 5 JL/X370 – 1680 and JL/XHD220 – 1010.

The default position for the 50/100% jumper is the 100% position, connecting the rightmost two pins together. The JL/X will be derated to 50% of the normal current rating if the jumper is placed in the 50% position, connecting the leftmost two pins together. It is also possible to remove the jumper completely, resulting in a low current rating suitable for use on small test motors (20A in the case of the frame 2 JL/X130 – 270 and JL/XHD75 – 160 and 30A in the case of the frame 4 and 5 JL/X370 – 1680 and JL/XHD220 – 1010).

It is also necessary to change parameter 680)Iarm BURDEN OHMS so that the JL/X software reflects the jumper physical position. This must be done via the JL/X MMI: Go to CONFIGURATION, DRIVE PERSONALITY, 680)Iarm BURDEN OHMS and examine the value. Set 680)Iarm BURDEN OHMS to twice that value then perform a PARAMETER SAVE. Remove the control supply on terminals 51, 52, 53 and reapply – this parameter is only read by the JL/X during its power up routines. The required value can then be set in 2)RATED STATOR AMPS.

The following table gives values of 680)Iarm BURDEN OHMS for all models, with required values for the jumper placed in the 100% position, the jumper placed in the 50% position and the jumper removed completely.

JL/X model	Required value for 680)Iarm BURDEN OHMS		
	Jumper in 100% position	Jumper in 50% position	Jumper removed
130	12.90	25.80	82.00
170	9.75	19.50	82.00
220	7.40	14.80	82.00
270	6.06	12.12	82.00
370	8.89	17.78	110.00
450	7.27	14.54	110.00
530	6.15	12.30	110.00
615	5.33	10.66	110.00
700	4.71	9.42	110.00
780	4.21	8.42	110.00
860	3.81	7.62	110.00
1025	3.20	6.40	110.00
1190	2.76	5.52	110.00
1350	2.42	4.84	110.00
1520	2.16	4.32	110.00
1680	1.95	3.90	110.00
75HD	12.89	25.78	81.99
100HD	9.74	19.48	81.99
130HD	7.39	14.78	81.99
160HD	6.05	12.10	81.99
220HD	8.88	17.76	109.99
270HD	7.26	14.52	109.99
320HD	6.14	12.28	109.99
370HD	5.32	10.64	109.99
420HD	4.70	9.40	109.99
470HD	4.20	8.40	109.99
520HD	3.80	7.60	109.99
615HD	3.19	6.38	109.99
715HD	2.75	5.50	109.99
815HD	2.41	4.82	109.99
910HD	2.15	4.30	109.99
1010HD	1.94	3.88	109.99

**Important note:** The actual current is determined by the physical burden jumper position. The setting of 680)Iarm BURDEN OHMS determines how the JL/X software displays values. The setting of 680)Iarm BURDEN OHMS should always match the values in the table above to avoid misinterpretation.

## 6.3 Functional settings

### 6.3.1 Ramp times

Navigate to the page containing the Run Mode Ramp and Stop Mode Ramp blocks

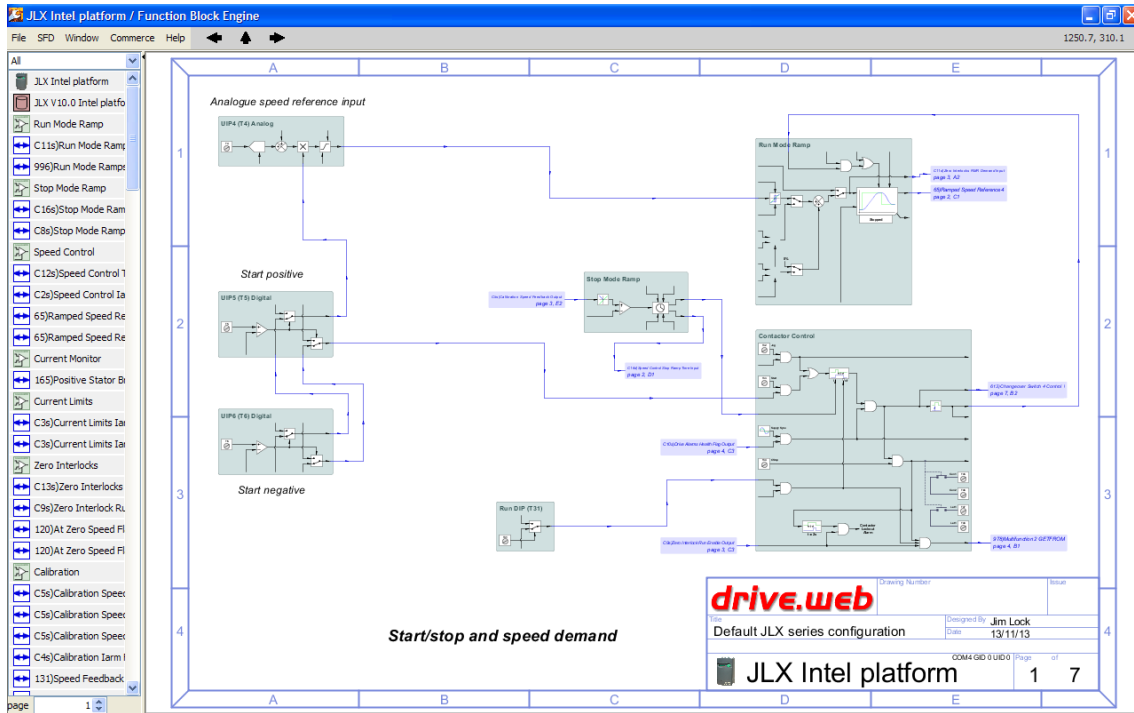

and left click on the Run Mode Ramp block.

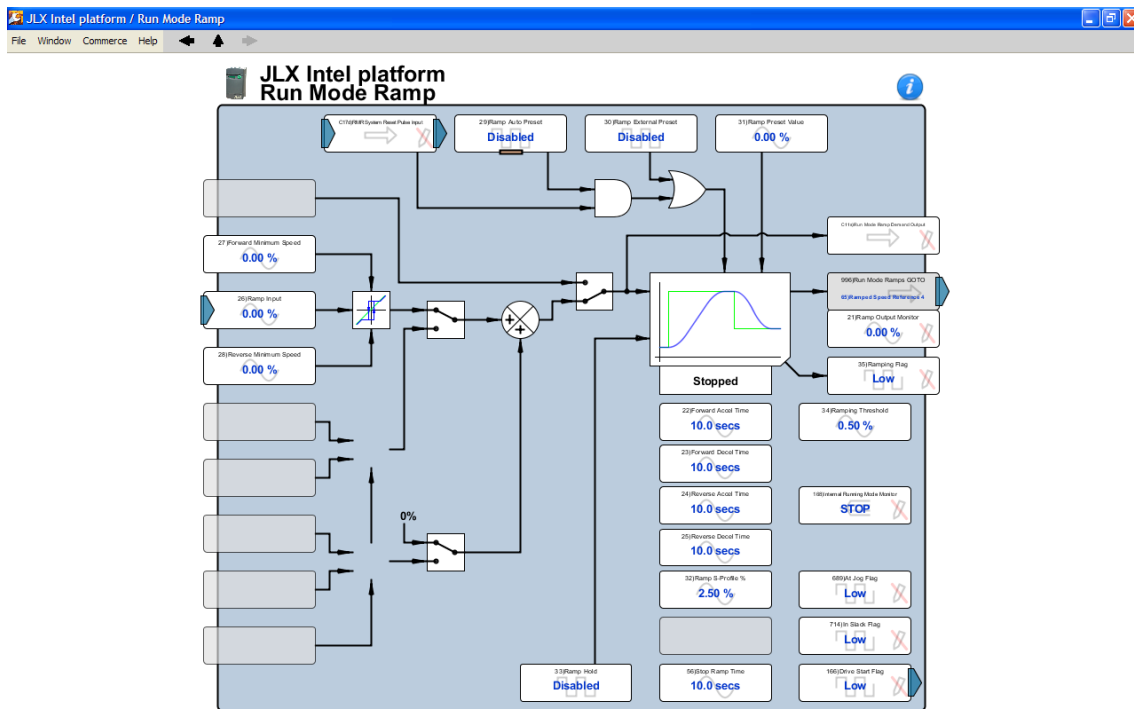

The settings required here are 22)Forward Accel Time, 23)Forward Decel Time, 24)Reverse Accel Time and 25)Reverse Decel Time. An S profile may be introduced if desired. These ramp times come into effect in response to a change of analogue speed demand on T4. Please note that the times entered will be those pertaining to a 100% change in demand. Use the back arrow to return to the block diagram page then left click on the Stop Mode Ramp block.

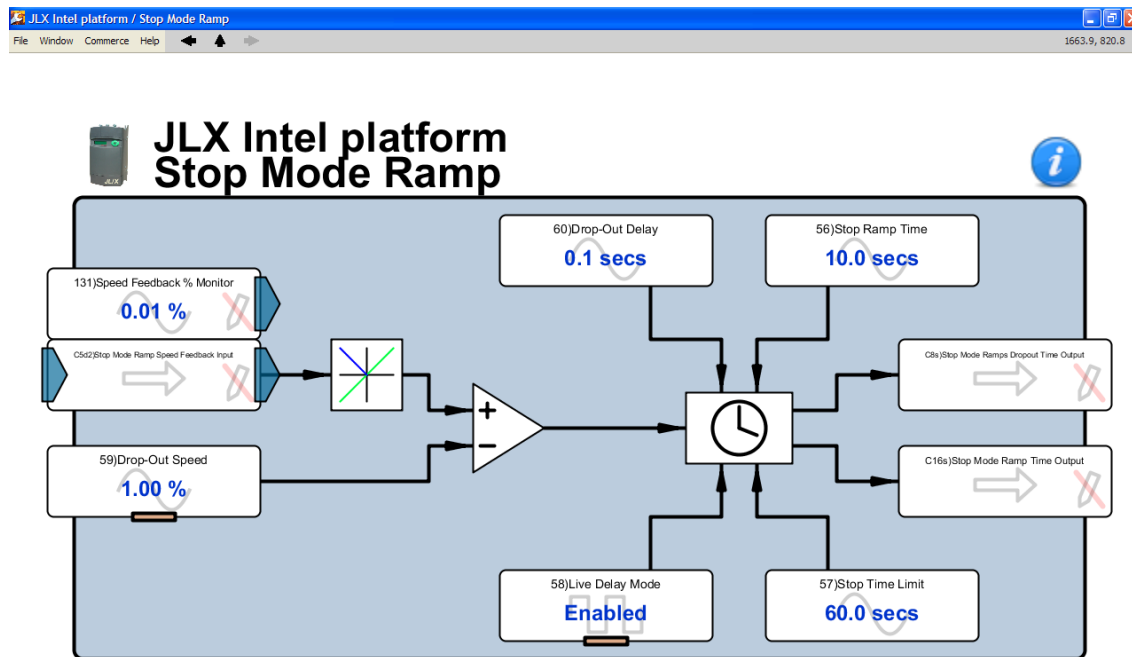

56)Stop Ramp Time is set here – usually to the same time as the previously set Run Mode Ramp times. This setting comes into effect when opening T33 (Start terminal) or (if used) the Start Positive or Start Negative terminals (T5 and T6).

### 6.3.2 Brake settings

The JL/X has two separate outputs used for brake control, T23 Brake Release Authorisation and T22 Brake Engage Demand. They are both arranged to be logical low for brake engage, and should be externally logically ANDed with a main supply contactor auxiliary. See manual basic wiring diagram for further information.

T23 Brake Release Authorisation will go high when Start is made and a certain value of stator current has been exceeded. It will then remain high until Start is removed, the motor has stopped and the main supply contactor de-energises.

T22 Brake Engage Demand will be high when the JL/X is started. It will go low when Start is removed and speed has fallen below a certain threshold.

To adjust T23 threshold: navigate to the page containing the Digital Outputs

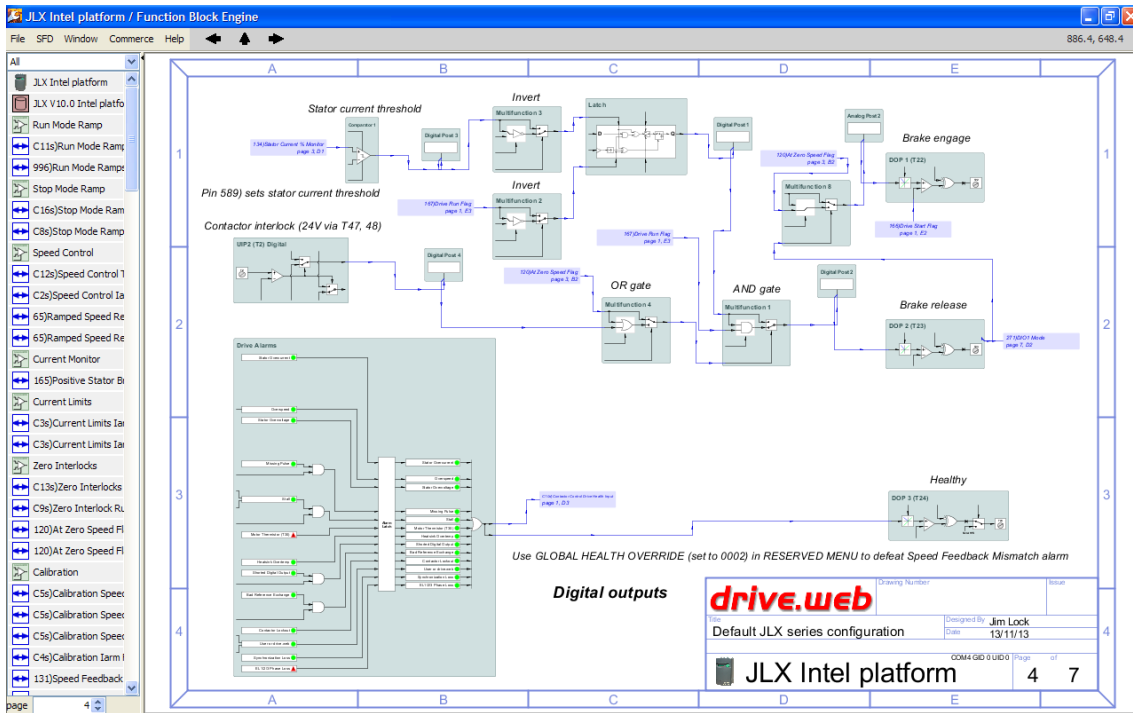

and left click on the Comparator 1 block.

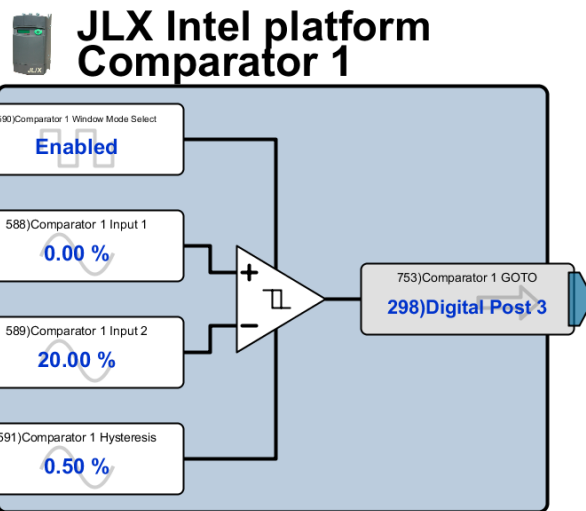

The Brake Release Authorisation stator current threshold is set by 589)Comparator 1 Input 2.

To adjust T22 threshold: navigate to the page containing the Zero Interlocks block

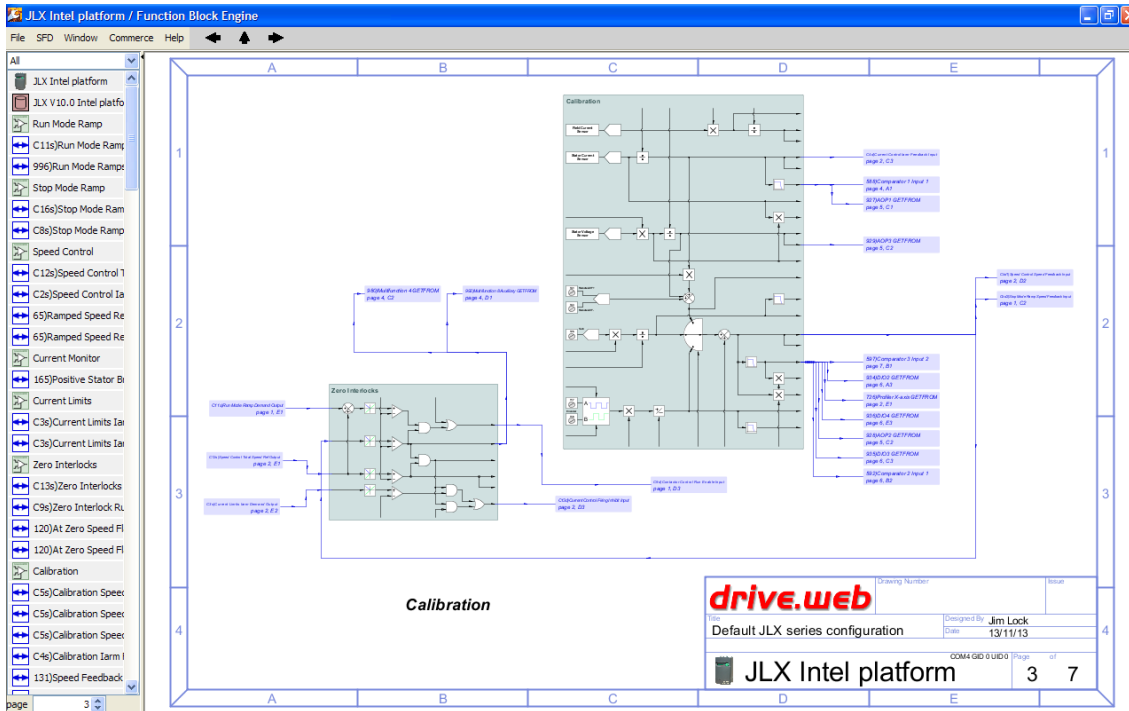

and left click on the Zero Interlocks block.

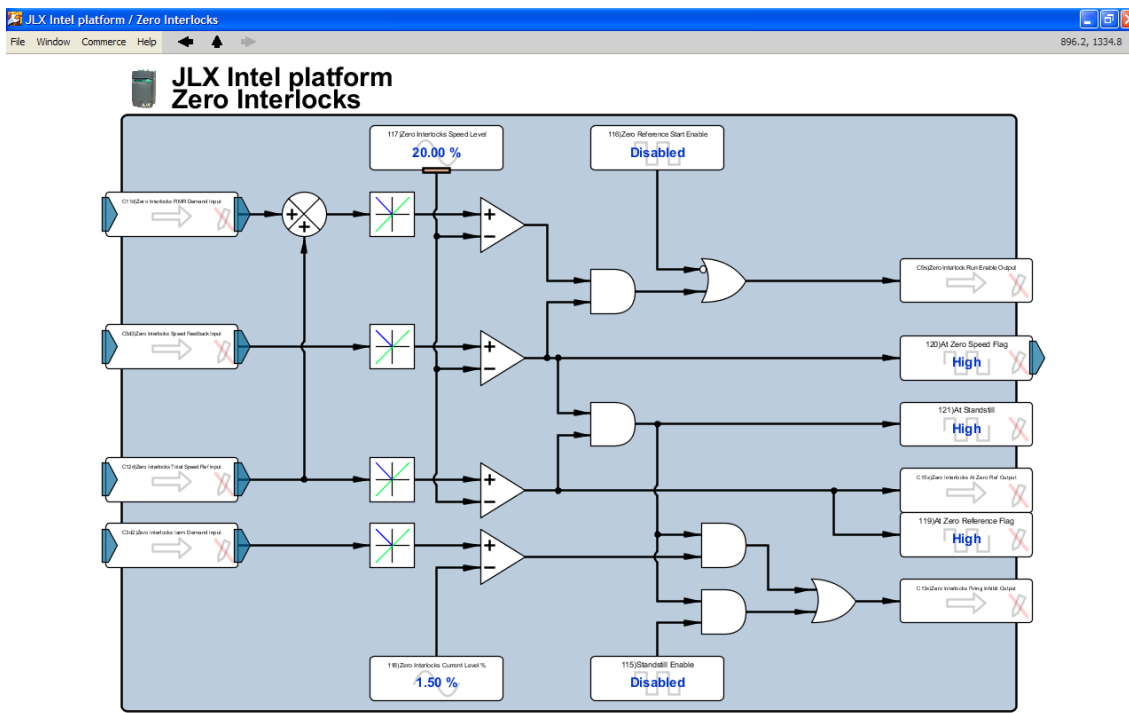

The threshold for Brake Engage Demand is set by 117)Zero Interlocks Speed Level.

**Important note:** In some circumstances it may be preferable to allow the JL/X to come to zero speed and remain enabled at zero speed for some time before engaging the brake. This may prevent brake wear by ensuring the brake does not engage until the motor is stationary, but does depend upon the maximum torque available at zero speed and thus the rotor resistance values chosen. If this is preferable, proceed as follows below – the threshold for Brake Engage Demand can then be set to a low value, say 1 or 2% (depending on brake closure time).

Navigate to the page containing the Stop Mode Ramp block

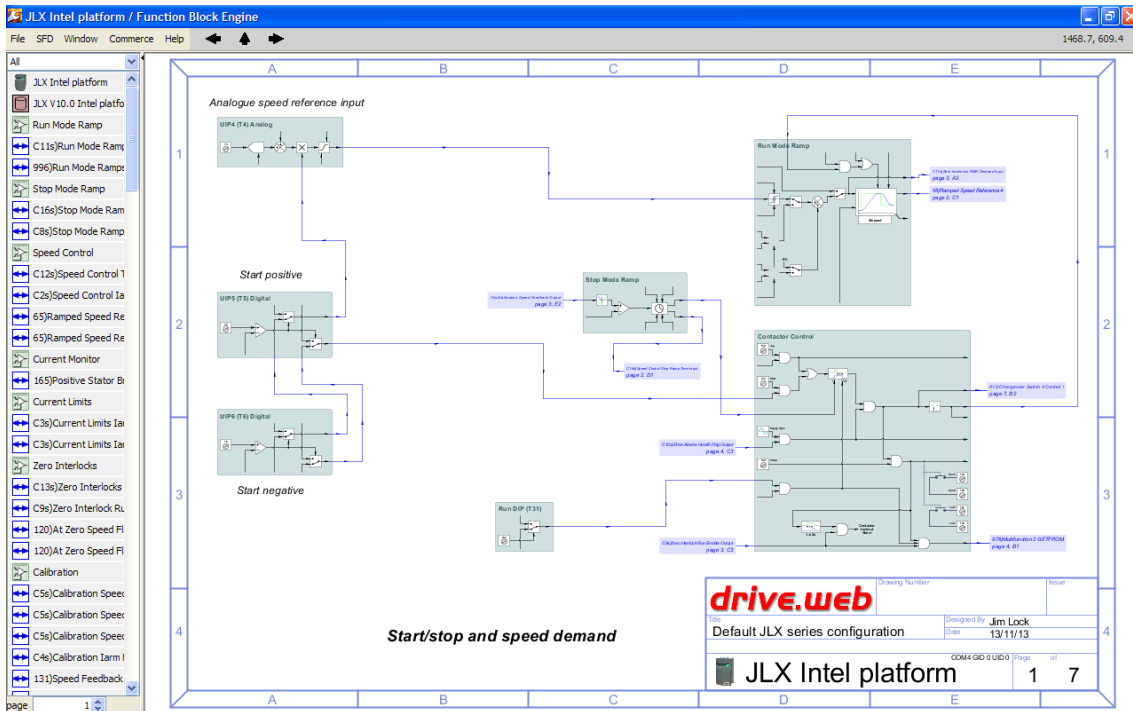

and left click on the Stop Mode Ramp block.

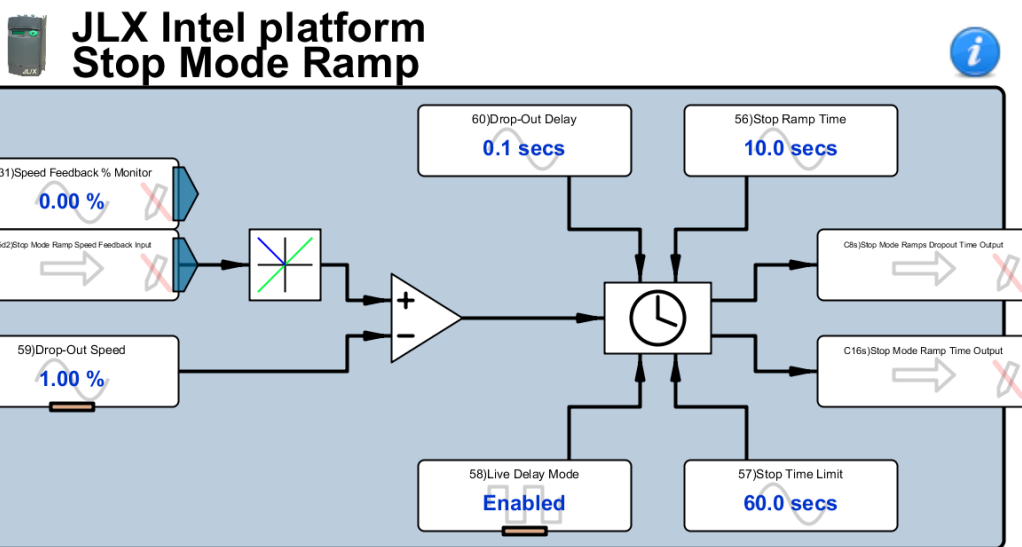

The time that the JL/X will remain enabled having reached zero speed and before de-energising the main supply contactor is set by 60)Drop Out Delay.

### 6.3.3 Hyper-synchronous detection settings

The JL/X has the ability to detect operation in the hyper-synchronous area. There are two possibilities: The hyper-synchronous area has been intentionally entered by the operator demanding full speed lowering with heavy load, or full speed X-Y travel with loading assistance, or The hyper-synchronous area has been entered unintentionally by loading assistance.

If the hyper-synchronous area has been entered intentionally, the JLX is forced onto the motoring bridge, rotor resistance is minimised and regeneration occurs. Under this circumstance the angle of maximum firing angle delay is automatically modified – by default, to 60 degrees. See later section 6.3.5 Adjusting stator firing angle minimum delay.

If the hyper-synchronous area has been entered unintentionally (i.e. without being demanded by the operator), plugging occurs with no rotor resistances shorted out for maximum torque availability.

To adjust the hyper-synchronous detection level, navigate to the page containing the Speed Control block

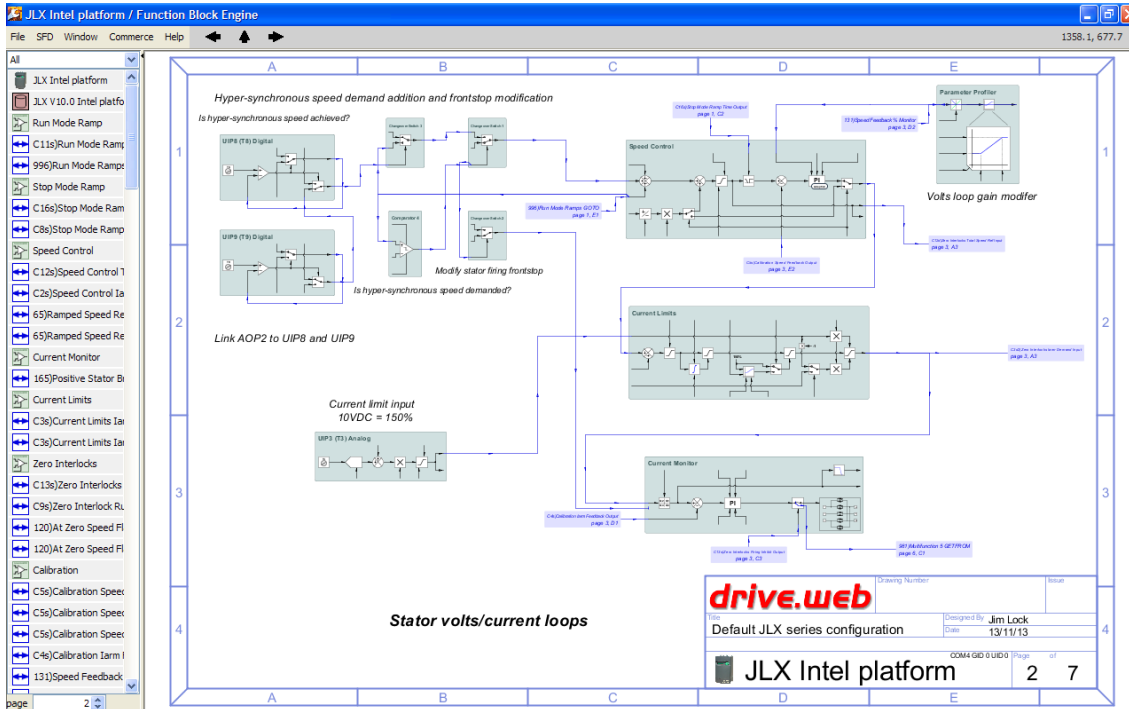

and left click on the UIP8 (T8) Digital block.

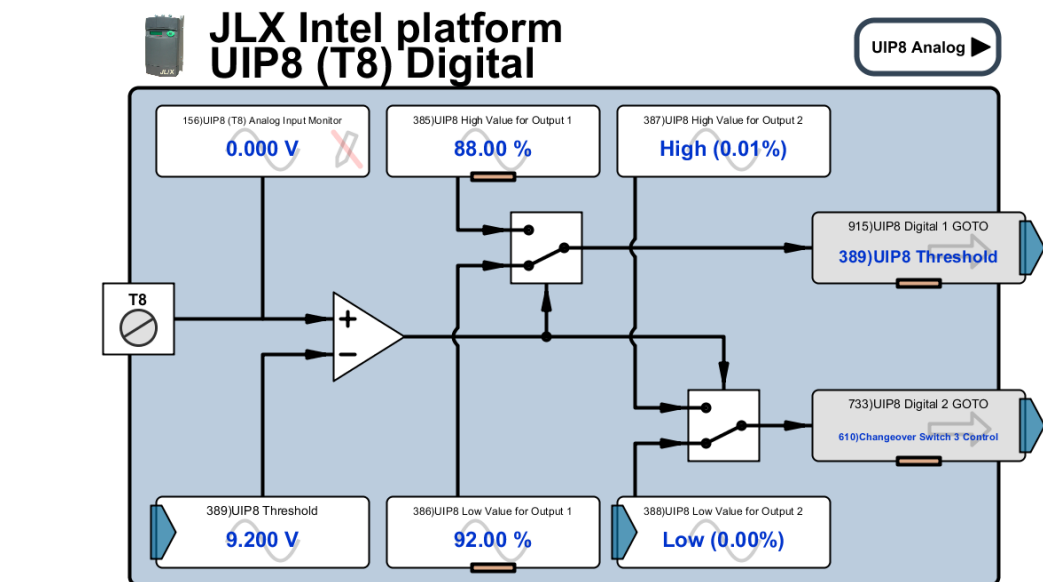

The positive hyper-synchronous detection level is set by 389)UIP8 Threshold. This in turn is set by 385)UIP8 High Value for Output 1 and 386)UIP8 Low Value for Output 1. The values for these parameters should be set symmetrically around the desired hyper-synchronous detection level in order to provide hysteresis. For example, a desired hyper-synchronous detection level of 90% speed (i.e. 90% of the previously set value for 6)Desired



Maximum RPM) requires 385)UIP8 High Value for Output 1 to be set to approximately 88.00% and 386)UIP8 Low Value for Output 1 to be set to approximately 92.00%. The exact values depend on how much hysteresis is required.

The negative hyper-synchronous detection level is set similarly. Left click on the back arrow to return to the block diagram page then left click on the UIP9 (T9) Digital block.

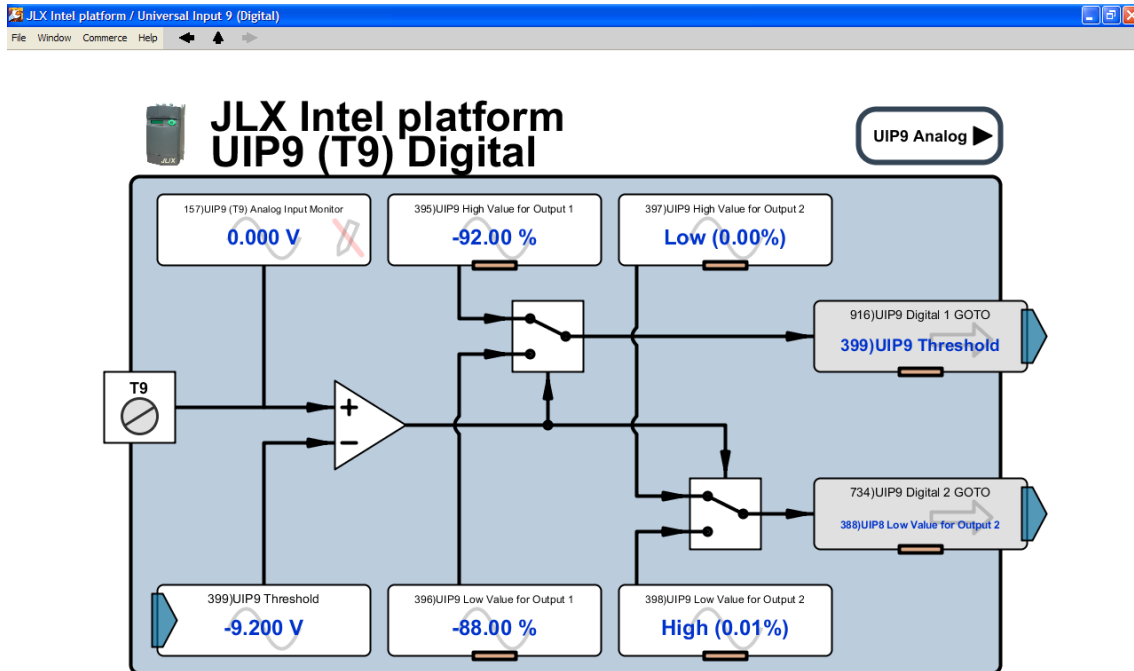

The negative hyper-synchronous detection level is set by 399)UIP9 Threshold. For example, a desired hyper-synchronous detection level of -90% speed (i.e. -90% of the previously set value for 6)Desired Maximum RPM) requires 395)UIP9 High Value for Output 1 to be set to approximately -92.00% and 396)UIP9 Low Value for Output 1 to be set to approximately -88.00%.

Both UIP8 and UIP9 need to be linked to AOP2 (total speed feedback monitor) to allow hyper-synchronous detection.

#### 6.3.4 Scaling the external speed demand and setting the hyper-synchronous demand detector

The JL/X has the facility to accept a single polarity speed demand on UIP4 with two terminals UIP5 and UIP6 then being used for Start Positive and Start Negative. In this case it is necessary to link T33 permanently to T35. Alternatively a bi-polar signal may be used into UIP4 with T33 being used for Start. In this case it is necessary to link T5 permanently to T35.

There are therefore potentially two parameters requiring adjustment in order to set the UIP4 scaling, 355)UIP5 High Value for Output 1 and 365)UIP6 High Value for Output 1.

**Important note:** It is necessary to scale UIP4 because of the value to which 6)Desired Maximum RPM was set earlier. It is important that the maximum speed that can be demanded corresponds to the rated speed of the motor (i.e. synchronous speed minus slip). This avoids instability caused by demanding a stator voltage in excess of that which can be supported by the supply, on a lightly loaded lowering motion or full speed X-Y travel without loading assistance.

For example, parameter 6)Desired Maximum RPM may be set to 918rpm as outlined in the calibration example previously given. The rated speed of that motor was 882rpm. Therefore the scaling factor to be applied to the speed demand on UIP4 is  $882/918 = 0.9608$ .

Navigate to the block diagram page containing UIP4 (T4) Analog.

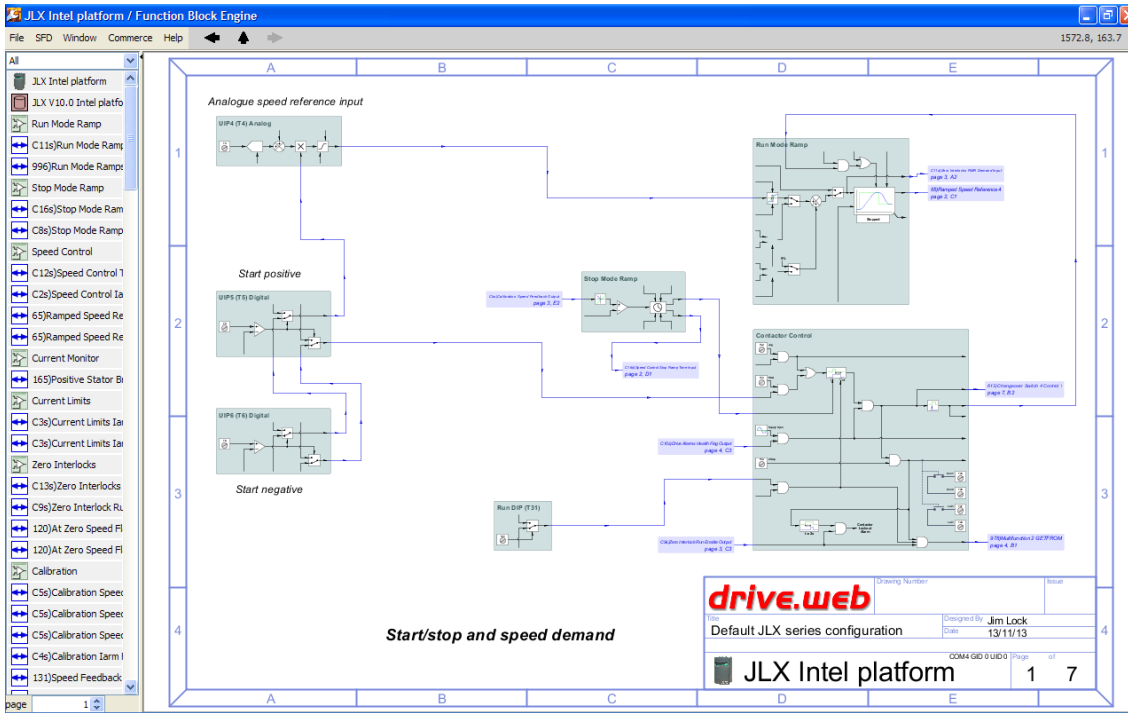

Left click on the UIP5 (T5) Digital block

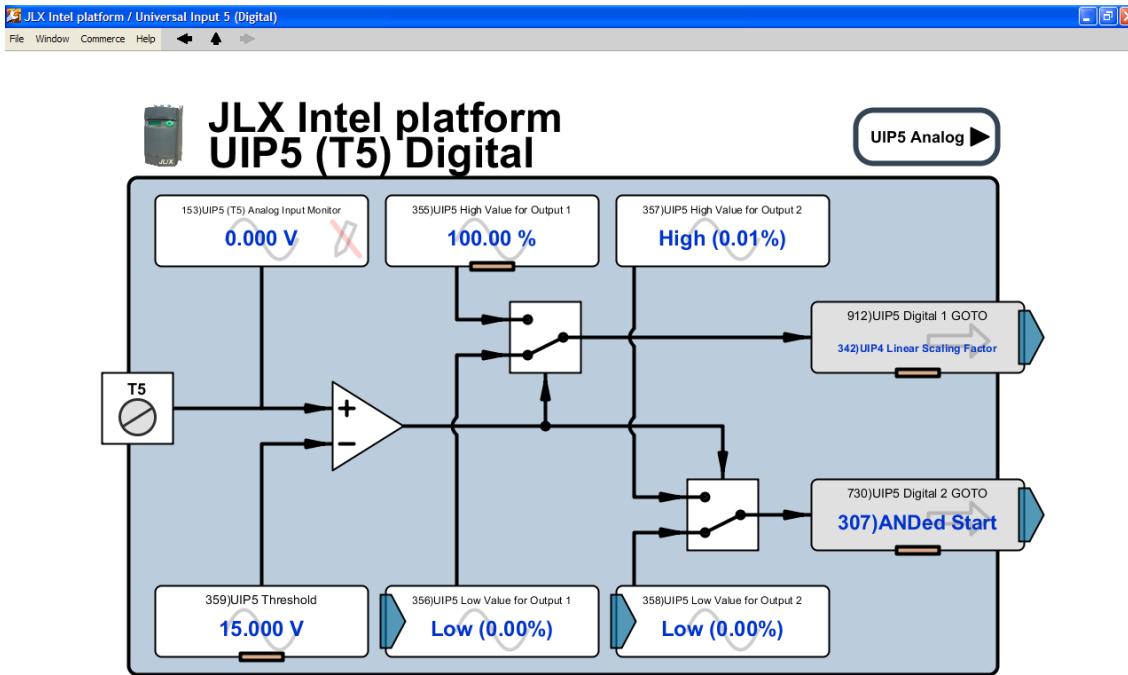

and set 355)UIP5 High Value for Output 1 to the previously calculated scaling factor.

If the external speed demand is single polarity it is also be necessary to scale the negative speed demand. Left click on the back arrow to return to the block diagram page then left click on the UIP6 (T6) Digital block,

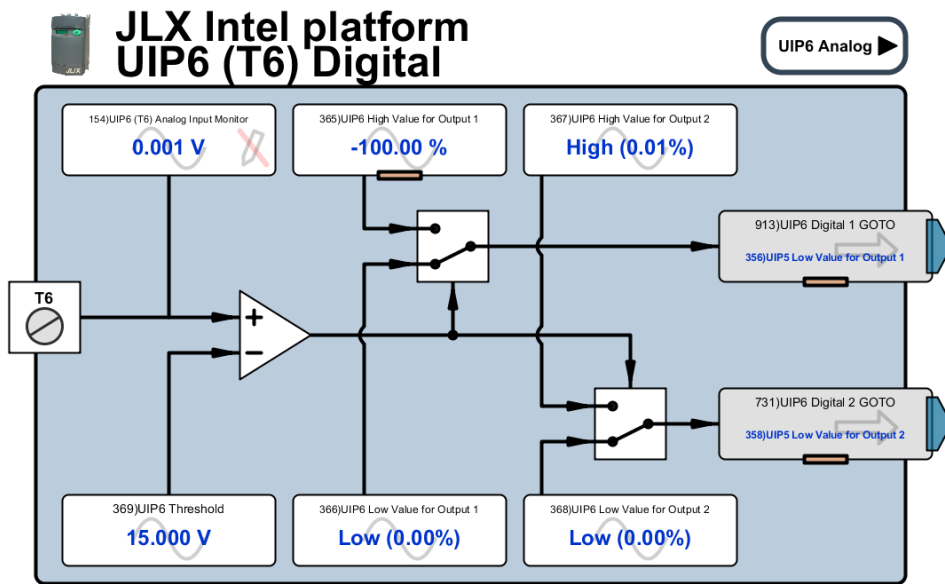

and set 365)UIP6 High Value for Output 1 accordingly (remembering this value has to be negative).

The above two steps ensure that the maximum speed that can be demanded by the operator is the rated speed of the motor (i.e. 882rpm, or 96.08% of the value set in 6)Desired Maximum RPM, in the example given).

The above assumes that the external speed demand system is capable of providing 10V for maximum speed demand. If a voltage smaller than 10V is available from the external speed demand system, the values above need to be calculated pro-rata from the maximum demand available.

Once UIP4 scaling is complete it is then possible to set the threshold for determining whether hyper-synchronous speed has been demanded by the operator: Navigate to the block diagram page containing the Comparator 4 block

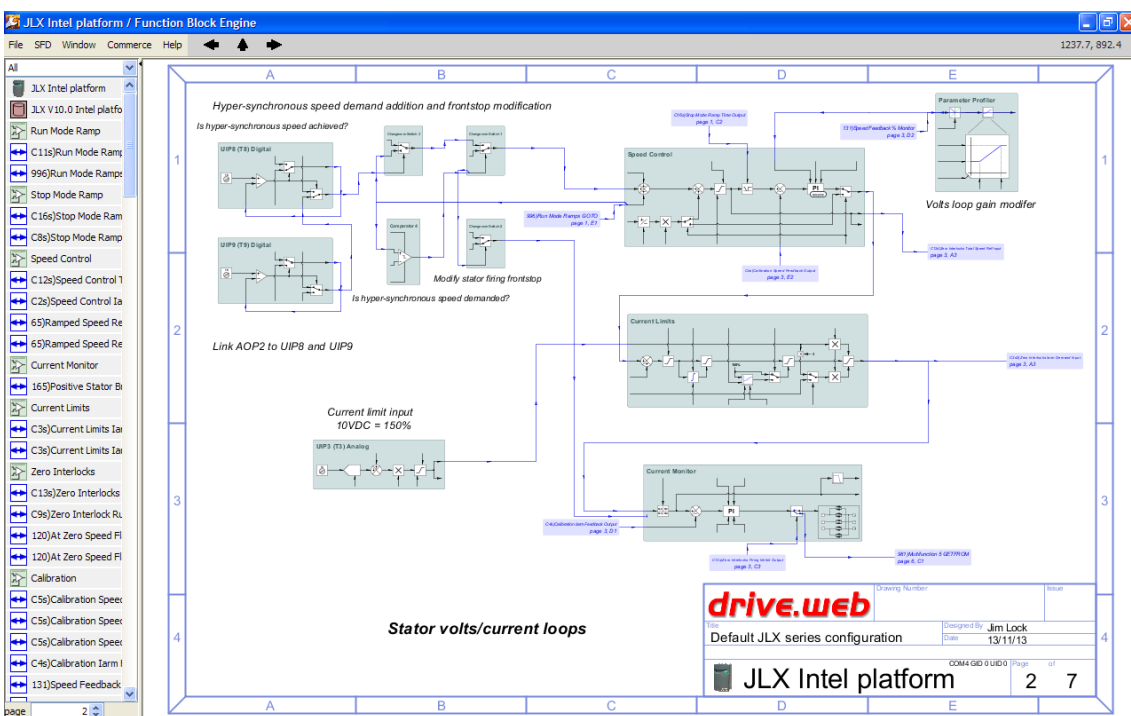

and left click on the Comparator 4 block.

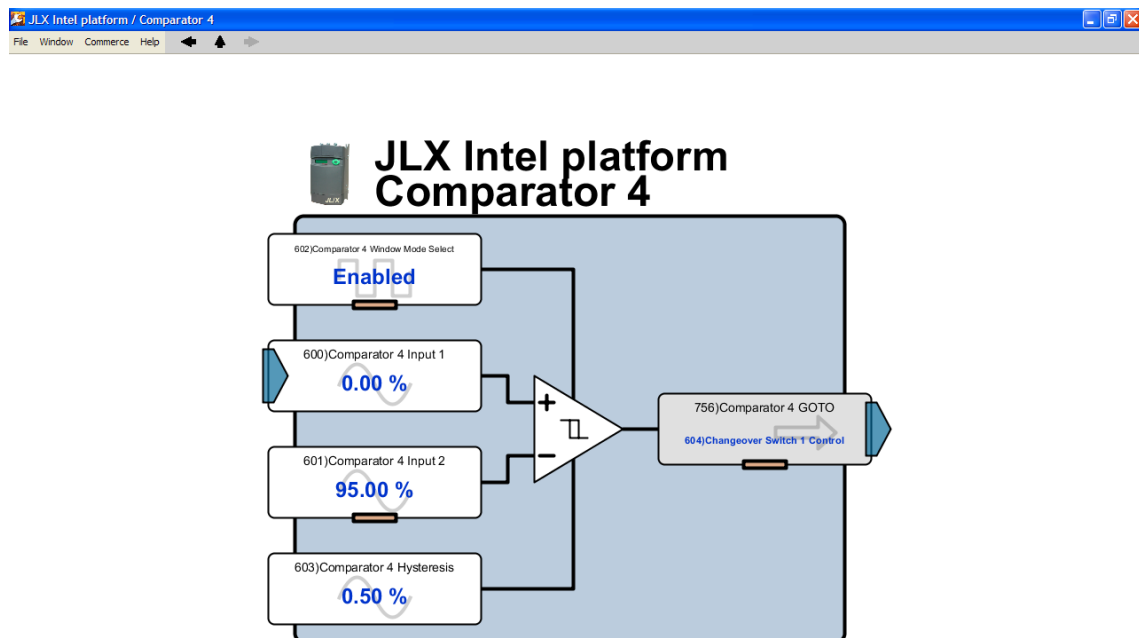

The threshold for sensing intentional hyper-synchronous operation is set by 601)Comparator 4 Input 2, with hysteresis set by 603)Comparator 4 Hysteresis. The setting is to be just less than the maximum demand available from UIP4, set previously.

### 6.3.5 Adjusting stator firing angle minimum delay

During normal running the minimum stator firing angle delay is approximately 8 degrees, set by parameter 98)Stator Firing Angle Frontstop to be seen in the Current Monitor block. When hyper-synchronous operation has been demanded and achieved, this parameter is automatically adjusted to approximately 60 degrees delay. If necessary, the limit may be adjusted. Navigate to the block diagram page containing Changeover Switch 2 block

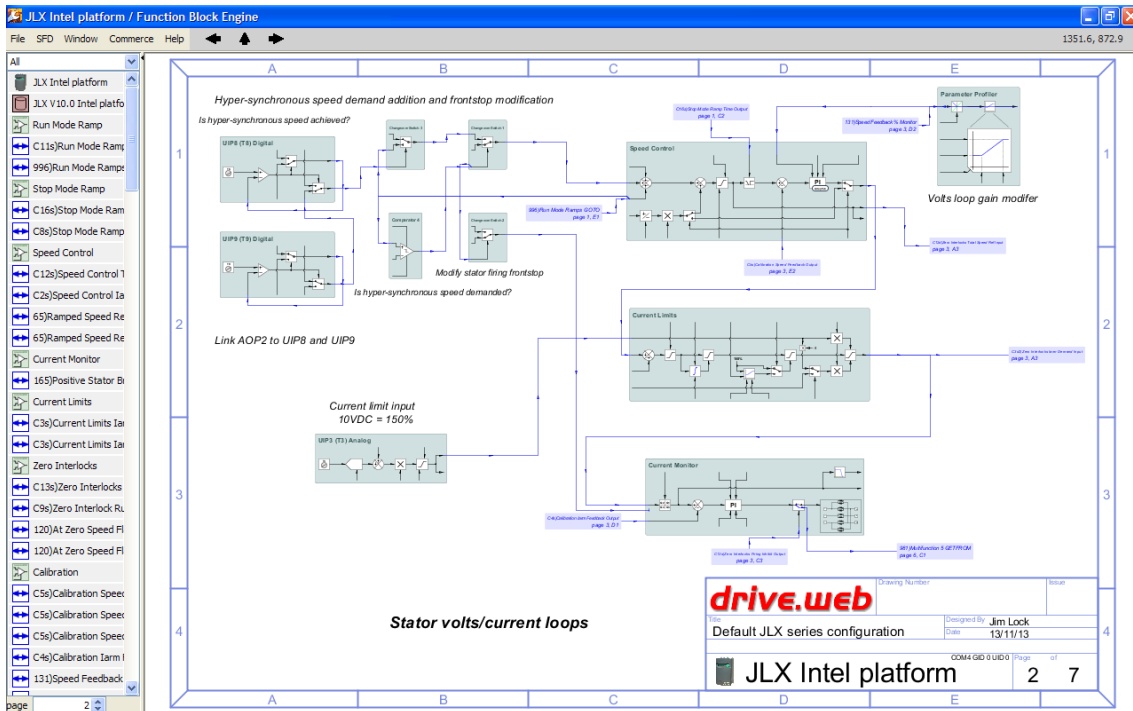

and left click on the Changeover Switch 2 block.

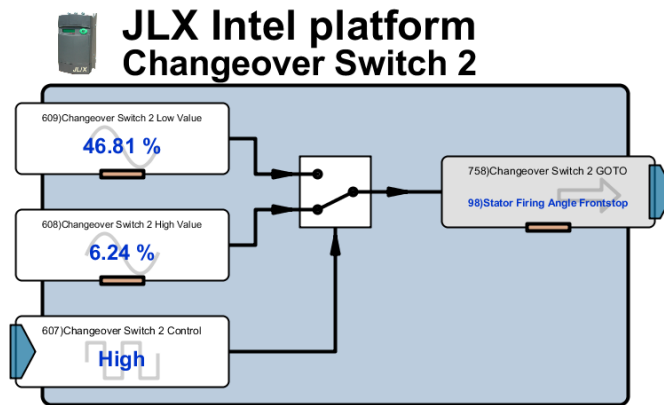

The stator firing angle minimum delay is set by 609)Changeover Switch 2 Low Value (when hyper-synchronous speed is demanded and achieved) and by 608)Changeover Switch 2 High Value under all other circumstances. The units are expressed as follows: (minimum delay \* 16384)/210 in degrees (only the integer number is taken, ignore the decimal places and % units). Thus the number for 60 degrees is  $(60 * 16384)/210 = 4681$ , and the number for 8 degrees is  $(8 * 16384)/210 = 624$  for example.

**Important note:** Fuse blowing may result if a number less than 624 for 608)Changeover Switch 2 High Value is used. A number greater than 4681 for 609)Changeover Switch 2 Low Value may result in an inability to produce rated stator volts. It is recommended that the default values are used.

### 6.3.6 Rotor resistance control settings

Navigate to the block diagram page containing the DIO1 (T18) block,

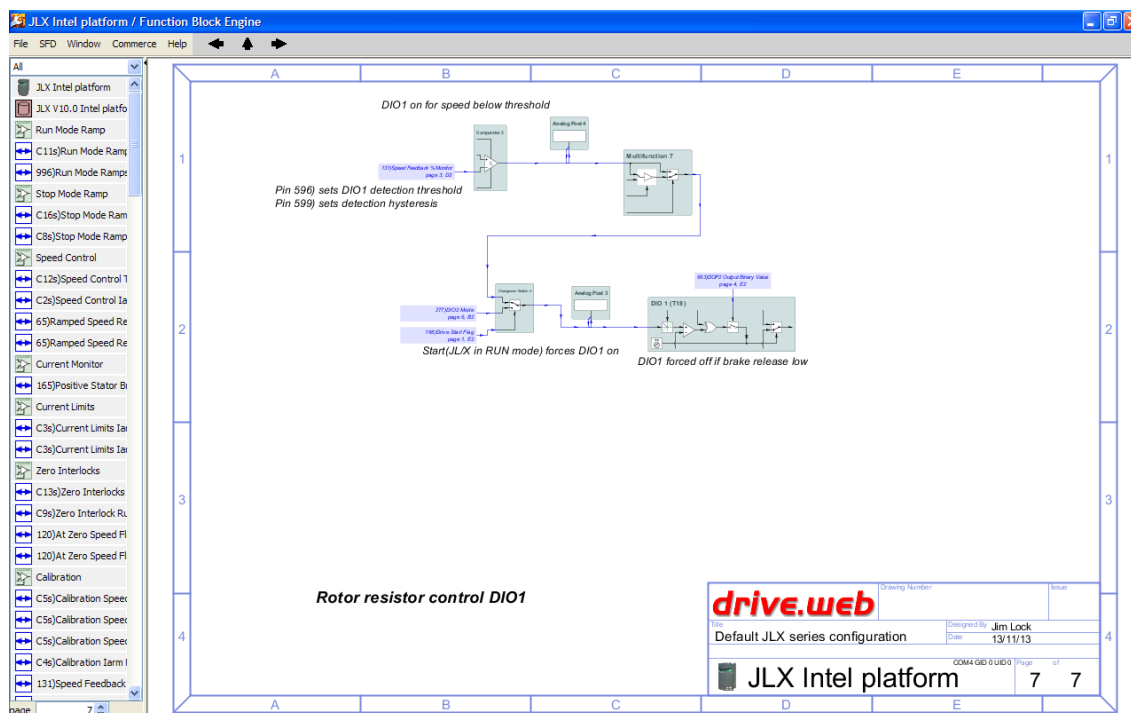

and left click on the Comparator 3 block.

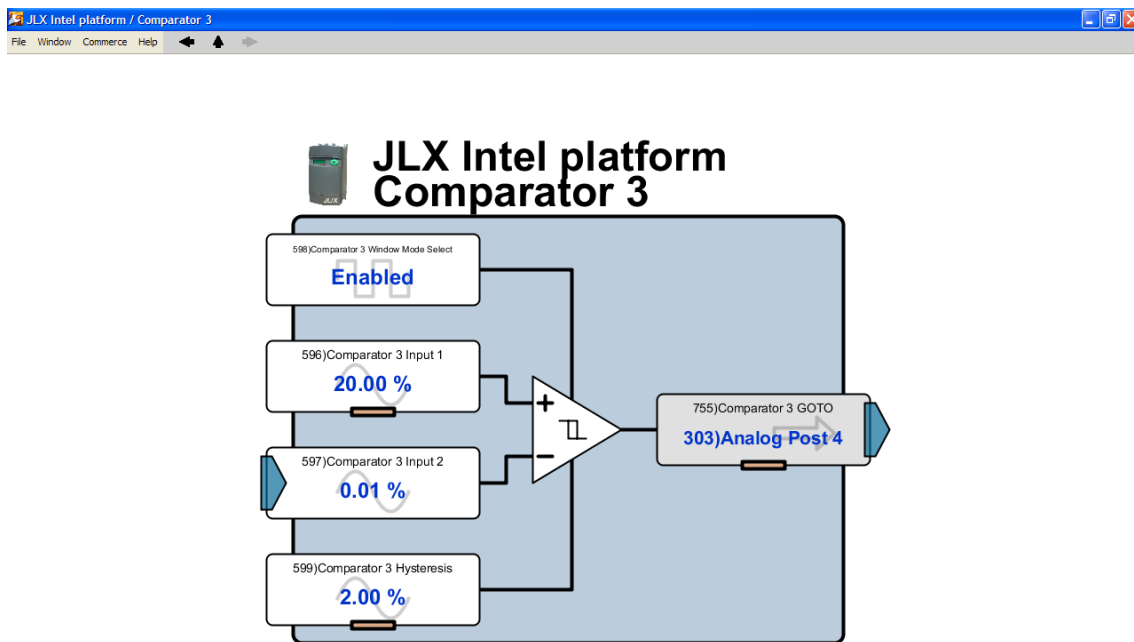

The threshold for DIO1 operation is set by 596)Comparator 3 Input 1, and hysteresis by 599)Comparator 3 Hysteresis.

There are three further rotor resistance control outputs available. The adjustment of only one (DIO2) is shown for simplicity. Navigate to the block diagram page containing the DIO2 (T19) block

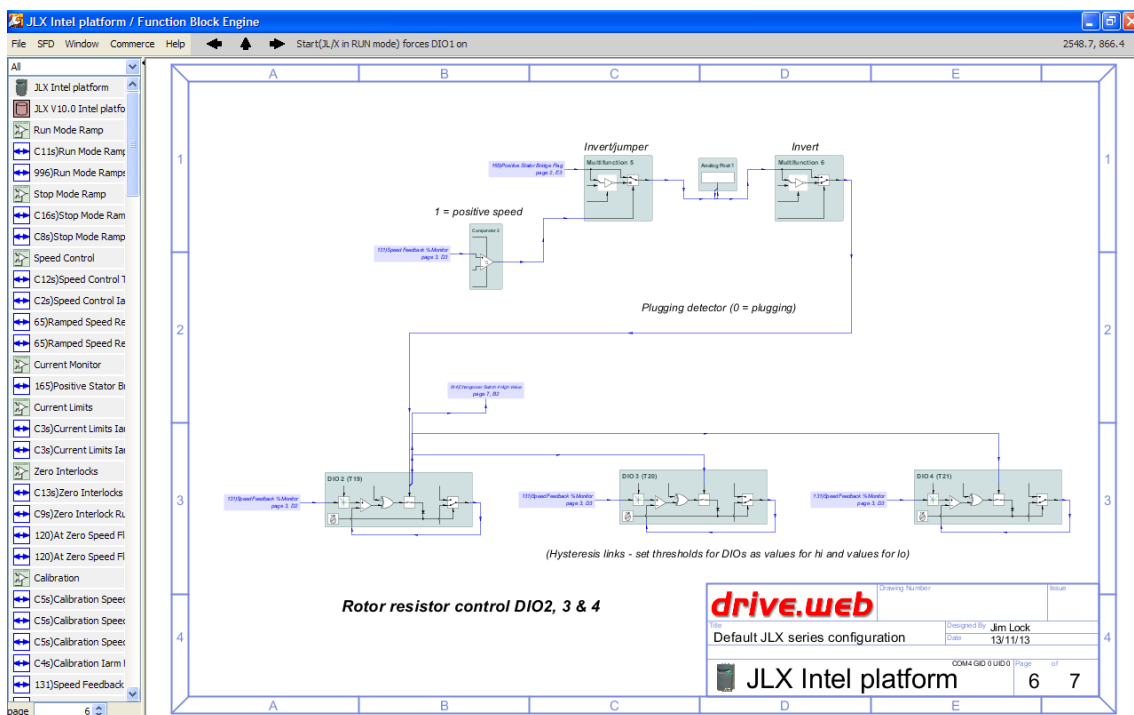

and left click on the DIO2 (T19) block.

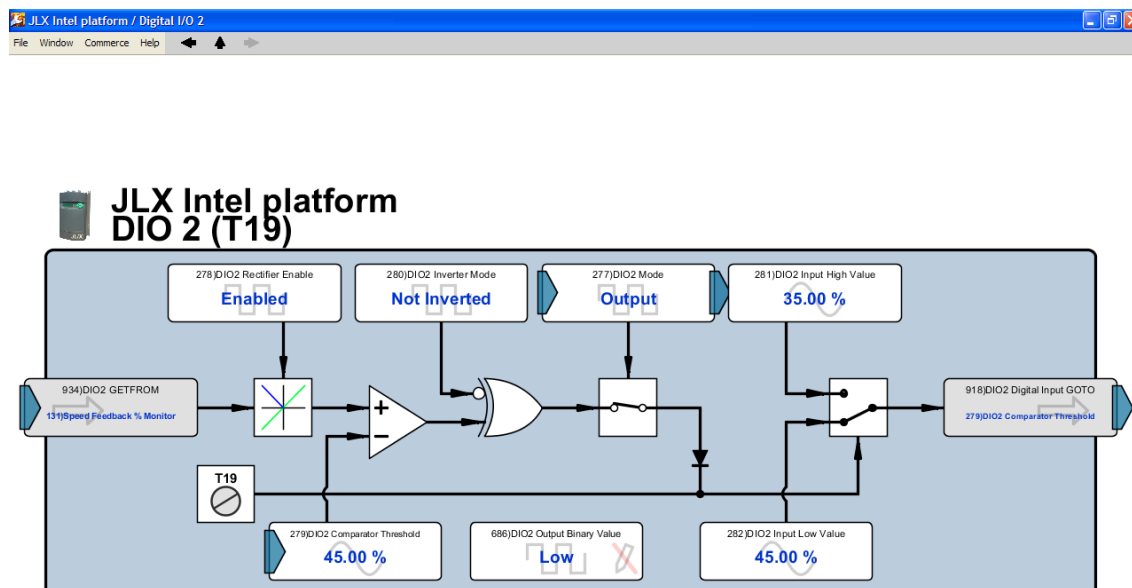

The threshold for DIO2 operation is set by 279)DIO2 Comparator Threshold. This in turn is set by 281)DIO2 Input High Value and 282)DIO2 Input Low Value. The values for these parameters should be set symmetrically around the desired DIO2 operating level in order to provide hysteresis. For example, a desired operating level of 40% speed requires 281)DIO2 Input High Value to be set to approximately 35.00% and 282)DIO2 Input Low Value to be set to approximately 45.00%. The exact values depend on how much hysteresis is required.

The operating thresholds for DIO3 and DIO4 are set similarly, if required.

Once all required parameters are set it is necessary to perform a PARAMETER SAVE. This can be done via the JL/X MMI in the normal way, or by right clicking on the JL/X icon within Savvy and selecting "Save All Parameters to EEPROM". It is also prudent to save a copy to your computer by using the Export Device Data function, in the same menu.

## 6.4 Speed and current loop tuning

**Important note:** For this procedure it will be necessary to access the JL/X Reserved Menu. If the JL/X is fitted with a drive.web card, it will be possible to adjust all mentioned parameters directly within Savvy. If the JL/X is not fitted with a drive.web board, or is being communicated with using the JL/X serial port, it will be necessary to adjust certain Reserved Menu parameters from the JL/X MMI, see later instructions.

It will probably be found that the default settings for the speed and current loops give a reasonable response. However, for higher inductance machines or for more demanding applications it may be necessary to give attention to the current loop and speed loop tuning. There are no Autotune facilities, manual tuning is the only method possible for both the speed and current loops.

A reasonable quality oscilloscope will be needed for these procedures.

If tuning is necessary, it is important that the JL/X current loop is tuned prior to the speed loop. Proceed as follows:

### 6.4.1 Current loop tuning

Arrange for the brake to be permanently engaged and for any rotor resistances in use to be permanently shorted out whilst the JL/X current loop is being tuned. This is easily arranged by removing either the brake release authorisation relay on T23 or the brake engage demand relay on T22 (assuming the JL/X brake control connections are as recommended), as well as arranging for any rotor resistor control relays on DIO1,2,3,4 to be permanently



energised by removing the connections to DIO1,2,3,4 and taking the connections to T35 (+24V) instead. Depending on brake efficiency and the rotor resistance method employed, it may also be necessary to arrange additional mechanical locking to the motor shaft to prevent rotation whilst the JL/X current loop is being tuned.

Navigate to the JL/X Reserved Menu page by left clicking on the JL/X icon at the top of the left hand menu bar

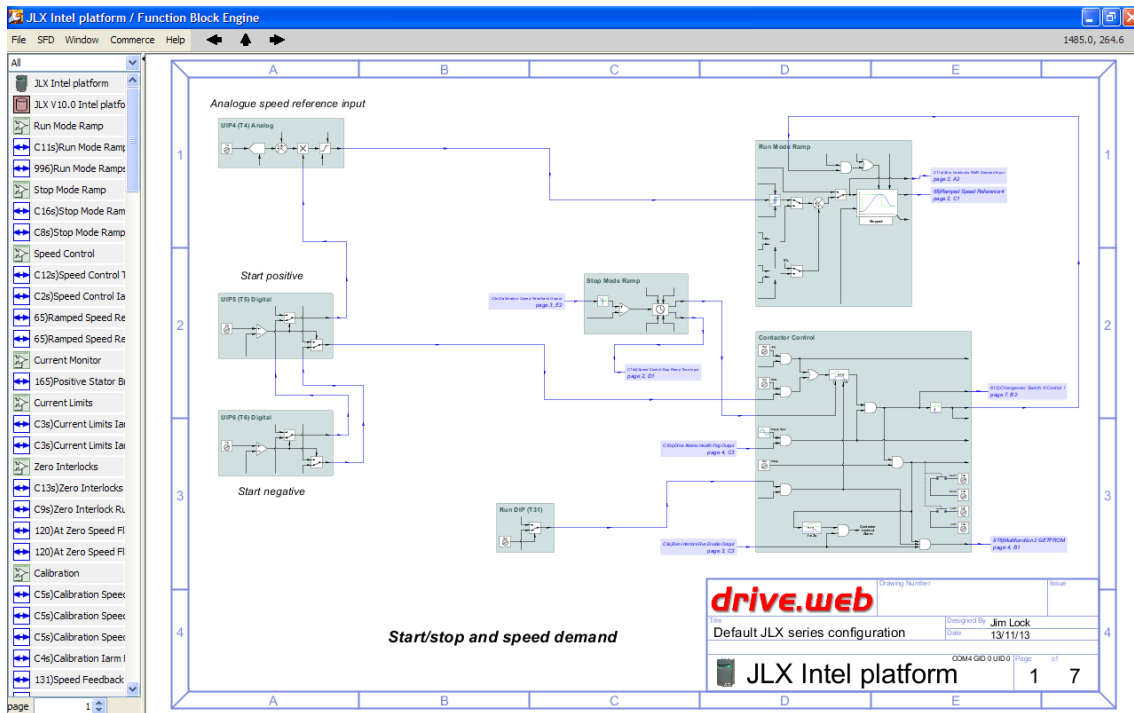

and then left clicking on the Reserved button of the screen that appears.

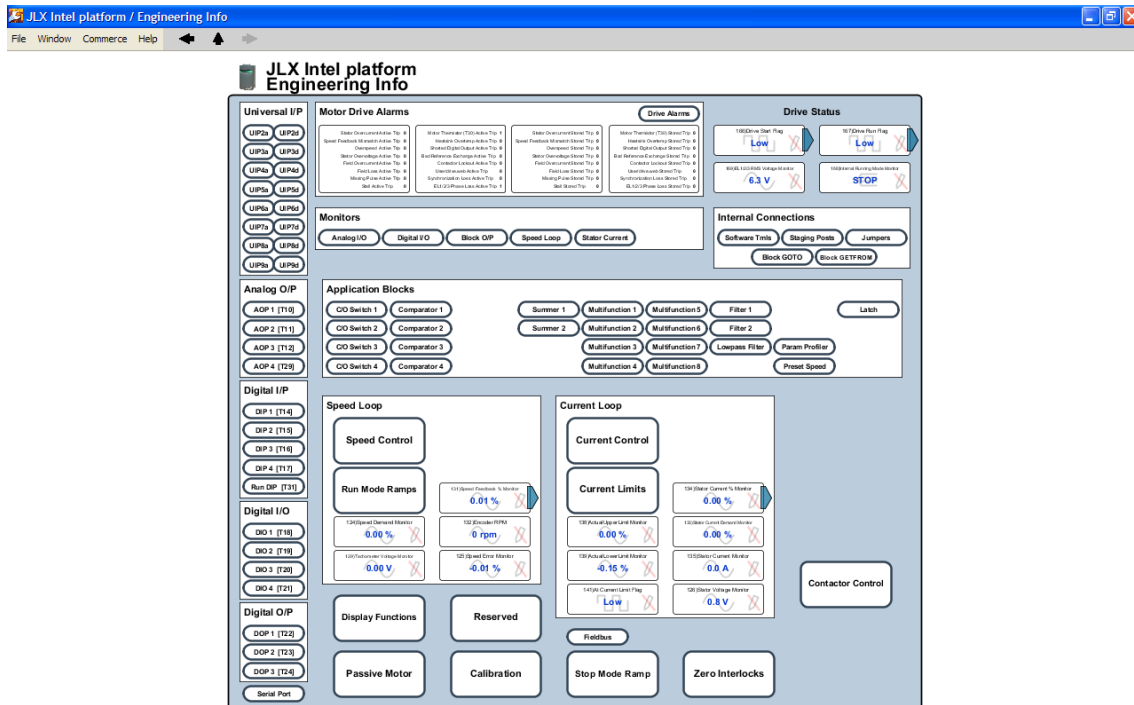

The Reserved Parameters screen opens:

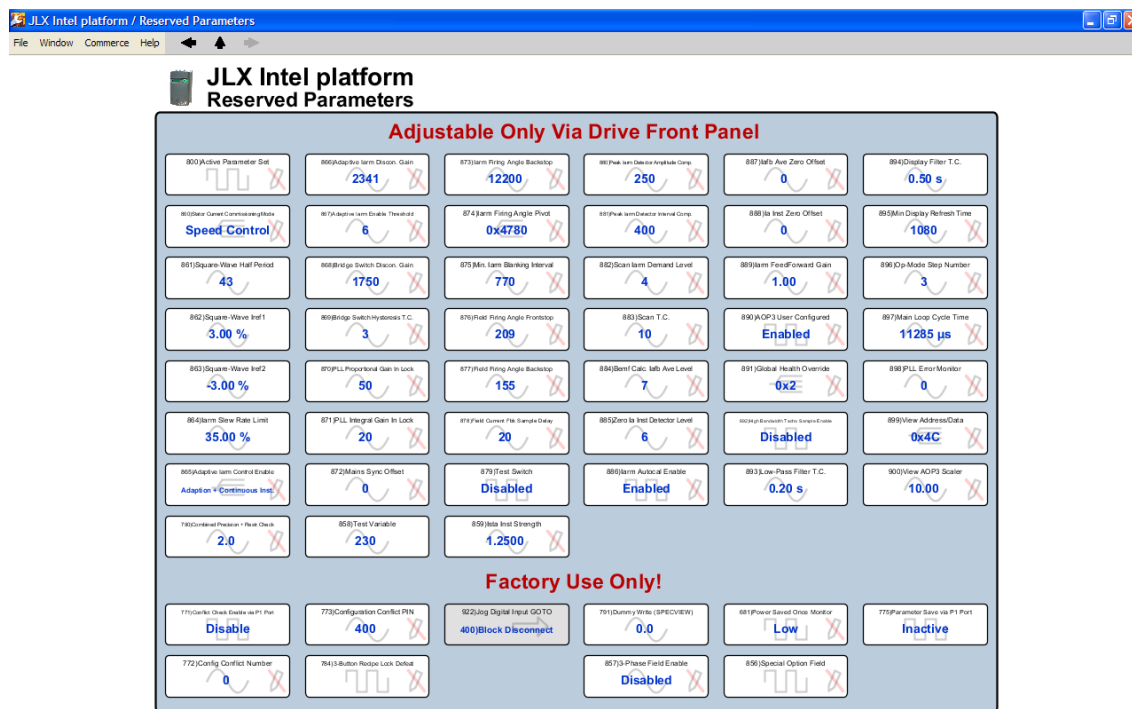

The parameters concerned are 860)Stator Current Commissioning Mode, 861)Square-Wave Half Period, 862)Square-Wave Iref1, 863)Square-Wave Iref2 and 875)Min. Iarm Blanking Interval. It may be found convenient to place a copy of these parameters into a separate viewing/adjustment window, together with the current loop adjustment parameters. If desired this can be done as follows:

Right click on the 860)Stator Current Commissioning Mode parameter and select “Add to Parameter Dock”. A new window opens containing the parameter.

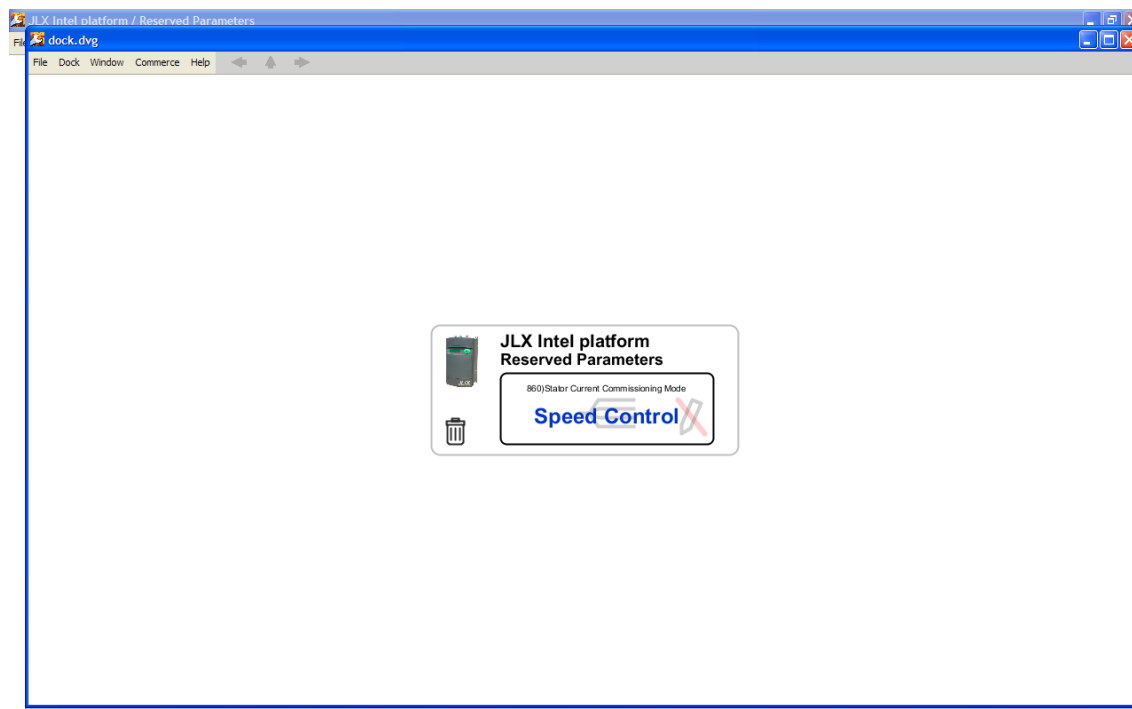

This window is called a dock window. It may be saved if desired using File, Save As.

Return to the Reserved Menu page and repeat for parameters 861)Square-Wave Half Period, 862)Square-Wave Iref1, 863)Square-Wave Iref2 and 875)Min. Iarm Blanking Interval. Navigate to the block diagram page containing the Current Monitor block and left click on that block.

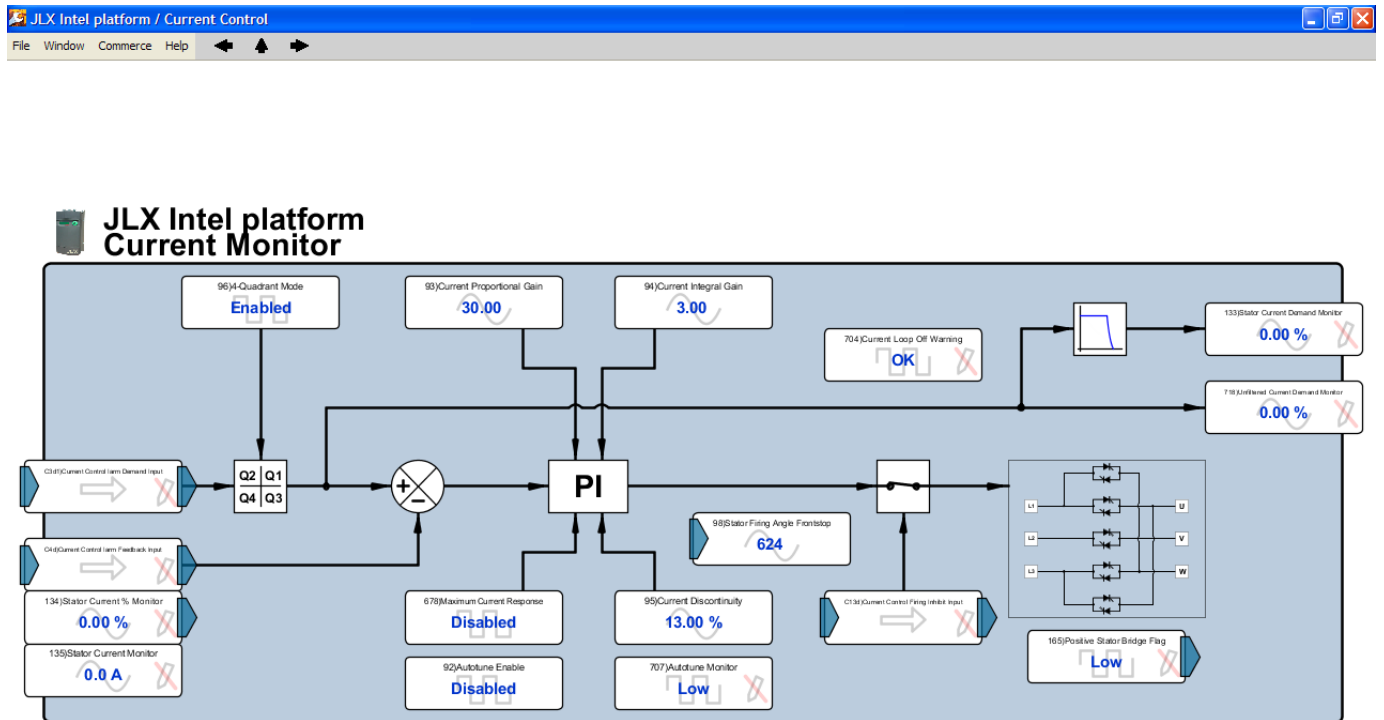

Right click on the 90)Current Proportional Gain parameter and select "Add to Parameter Dock". Repeat for the 94)Current Integral Gain and 95)Current Discontinuity parameters. Navigate to the dock page, which should now appear similar to this.

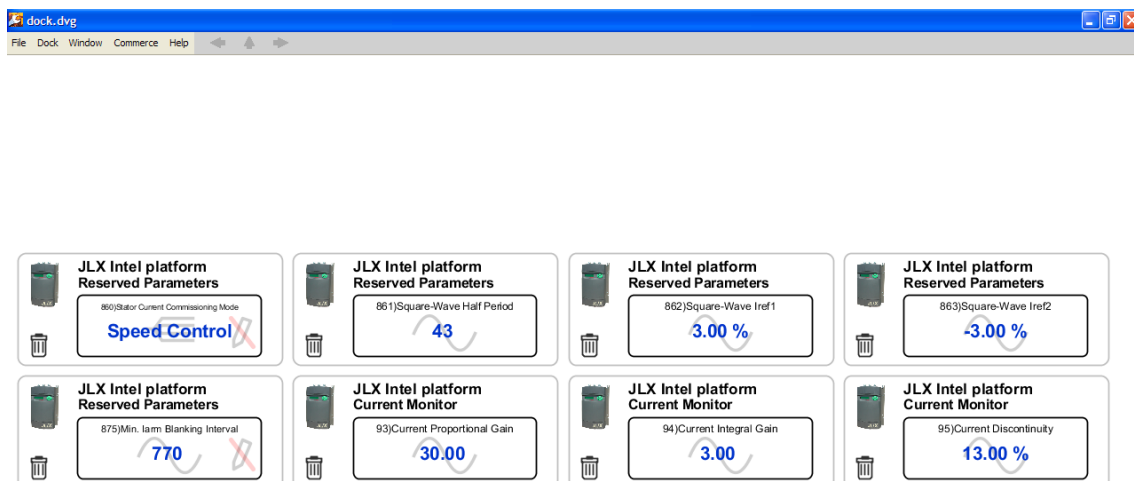

This gives a convenient place to store all the parameters required for current loop tuning.

**Important note:** The screenshot above is taken from a non drive.web equipped JL/X so the first parameter required is read only and must be adjusted from the JL/X MMI as follows: On the JL/X MMI, navigate to DISPLAY FUNCTIONS, PASSWORD CONTROL, ENTER PASSWORD and set to FEFA. Then navigate to the CONFIGURATION menu, which now contains the DRIVE RESERVED MENU. Enter this menu using the right key several times until the display reads Iarm COMMISSION.MODE on the top line and 2 on the bottom line. Set to this parameter to 0. The dock window now appears as follows:

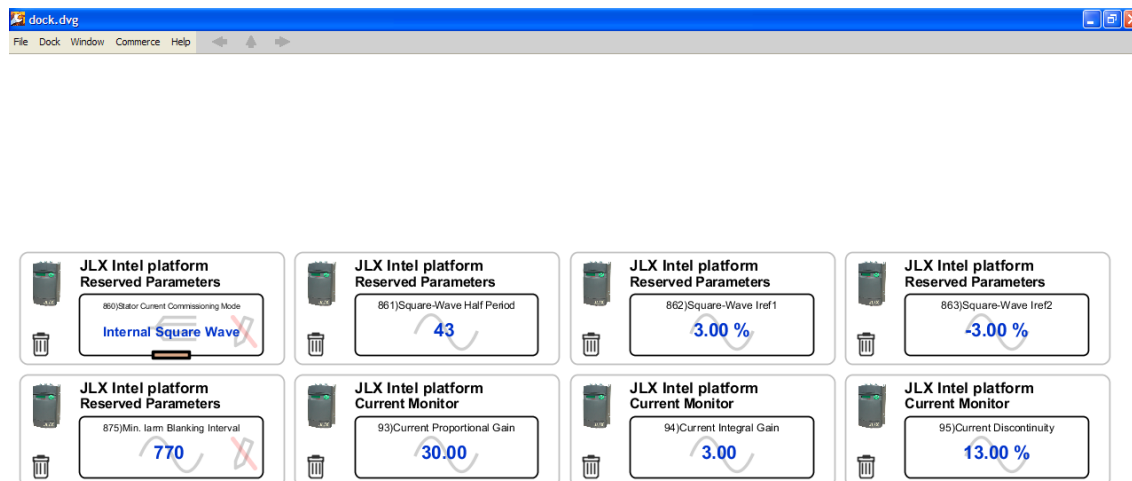

---

Parameter 860)Stator Current Commissioning Mode is the Savvy equivalent of the JL/X RESERVED MENU parameter Iarm COMMISSION.MODE. Note that the value displayed has now changed to Internal Square Wave.

(If the JL/X is drive.web equipped it is possible to change 860)Stator Current Commissioning Mode directly from the Savvy screen, as normal).

It is suggested that 862)Square-Wave Iref1 and 863)Square-Wave Iref2 are set initially to 10.00 and -10.00 respectively, with 861)Square-Wave Half Period left at default value (43) and 875)Min Iarm Blanking Interval set to a value of 6. (If the JL/X is drive.web equipped it is possible to change this parameter value directly from the Savvy screen). On a non drive.web equipped JL/X, it will be necessary to adjust this parameter via the JL/X MMI by navigating to the CONFIGURATION, DRIVE RESERVED MENU as before. Enter this menu using the right key several times until the display reads Iarm COMMISSION.MODE on the bottom line then use the up or down keys until the display reads BLANKING INTERVAL on the bottom line. Enter this parameter with the right key and set to 6. Parameter 875)Min Iarm Blanking Interval is the Savvy equivalent of the JL/X RESERVED MENU parameter BLANKING INTERVAL.

When started, the JL/X will now make current with current demand switching between the two levels set by 862)Square-Wave Iref1 and 863)Square-Wave Iref2, with a half cycle time of approximately 43 current pulses (about 140mS, on a 50Hz supply). The waveform seen on the JL/X control board Ia test point should look similar to the following picture.

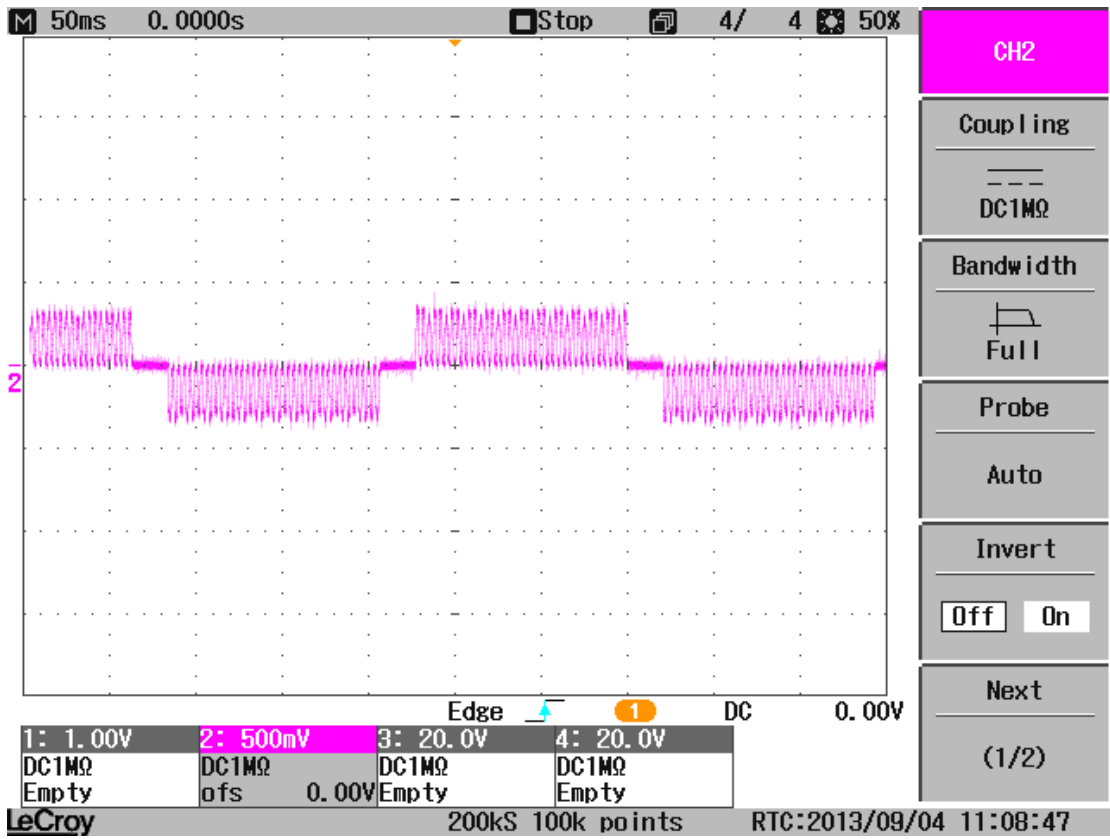

The next picture shows a close up of the zero current region as the JL/X switches bridges. There should be a “dead time” around zero current of around 18mS (on a 50Hz supply) as the following picture shows, but the “dead time” may well be shorter if the stator is highly inductive.

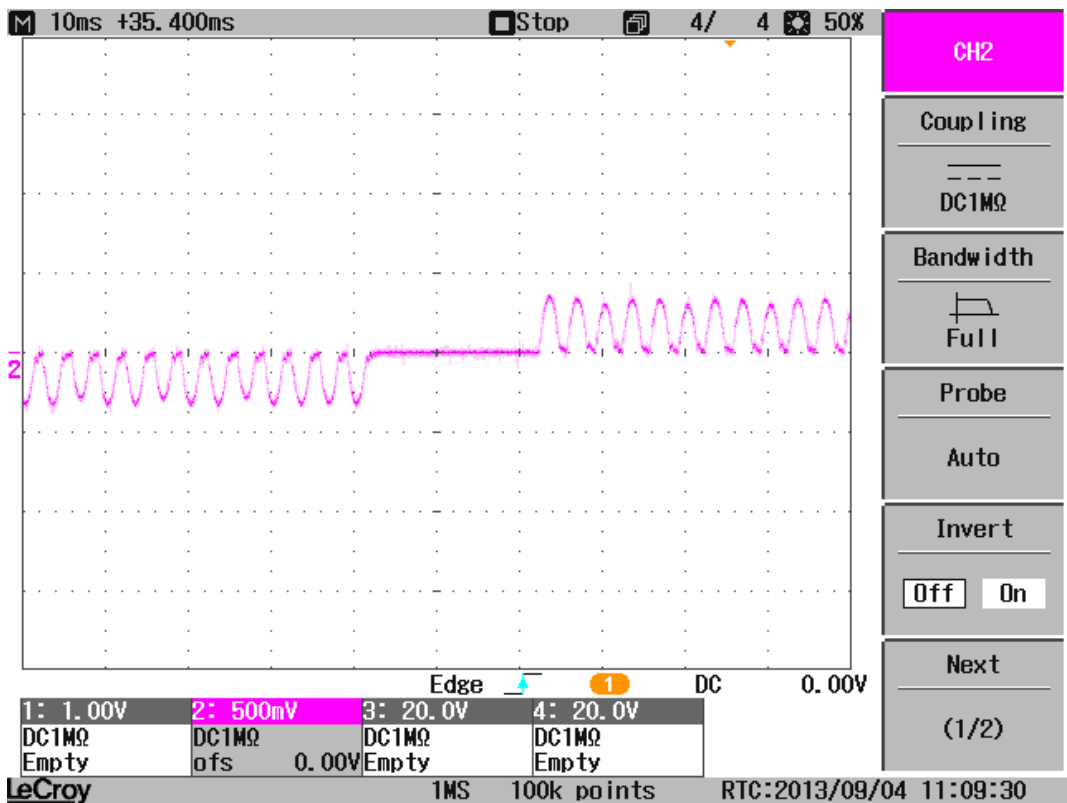

If a reasonable minimum “dead time” (say minimum of 6 to 8mS) is not observed because the stator is highly inductive please see later section 6.4.3 Special techniques for highly inductive stators.

Leaving 875)Min. Iarm Blanking Interval set to 6, proceed to tune the current loop as follows, assuming the waveform appeared similar to the above and the “dead time” around zero current was reasonable. The first stage is to establish at what level the current becomes continuous. This can be done by temporarily setting 861)Square-Wave Half Period to a higher value, say 200, in order to allow the current time to stabilise. The stable portion of the waveform can then be examined to establish whether the current is continuous or not. See following examples:

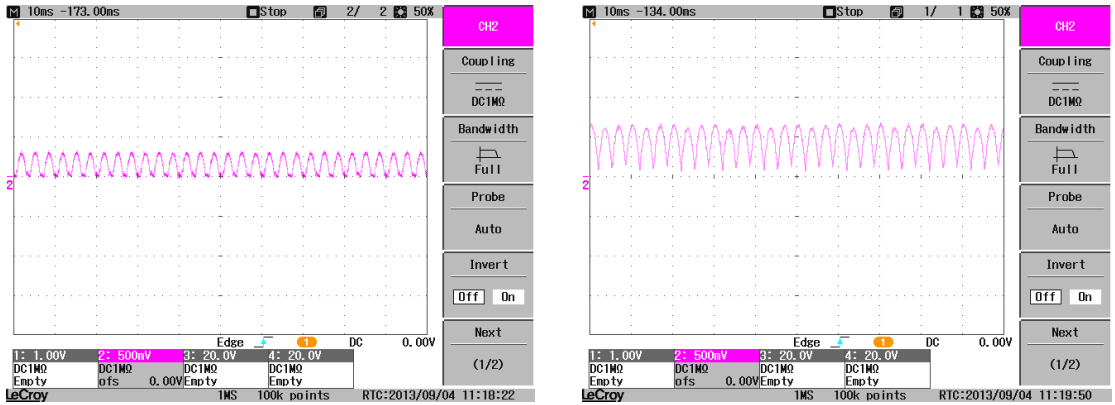

Discontinuous current is where the current pulses are discrete and have portions between them sitting on the 0V datum (left hand picture). Continuous current is where the current pulses join together and lift away from the 0V datum (right hand picture).

If the current is not continuous, increase the settings of 862)Square-Wave Iref1 and 863)Square-Wave Iref2 symmetrically in small amounts until it is observed that the current is just continuous when stable then stop the JL/X, return 861)Square-Wave Half Period to value 43 and note the value set in 862)Square-Wave Iref1. Enter the same value into parameter 95)Current Discontinuity.

Start the JL/X and increase the values of 862)Square-Wave Iref1 and 863)Square-Wave Iref2 (always symmetrically) in stages whilst observing response and adjusting parameters 94)Current Integral Gain and 93)Current Proportional Gain. Generally, the technique is to increase 94)Current Integral Gain to reduce current rise time whilst increasing 93)Current Proportional Gain to damp out any instability that may be induced. Ideally the tuning should be performed at as high a current as possible, corresponding to values of 150.00 and –150.00 for 862)Square-Wave Iref1 and 863)Square-Wave Iref2 respectively. However this may not be possible, particularly on systems where switched rotor resistances are not used. In these cases, perform the tuning at as high a current level as possible consistent with not stressing the braking system unduly. If shaft rotation is observed during the tuning it will be necessary to perform the tuning at a lower current level.

When complete, the current loop response should be similar to the following:

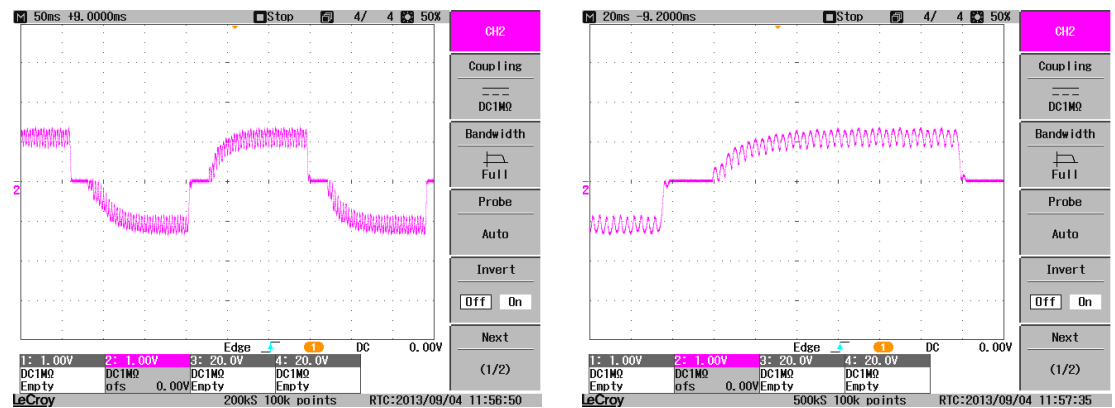

**Important note:** The maximum average level observed on the oscilloscope trace will be scaled according the ratio of your setting for 2)RATED STATOR AMPS against the maximum current capability of the JL/X model in use. The

maximum will be 3V for 150% current on a JL/X set for it's maximum current capability. For example, a setting for 2)RATED STATOR AMPS corresponding to 50% of the model maximum current rating would result in a maximum average level of 1.5V on the oscilloscope trace.

It will not normally be necessary to be concerned with current loop performance at very low current levels, i.e. when the current is discontinuous.

The next two pictures show examples of poorly tuned current loops.

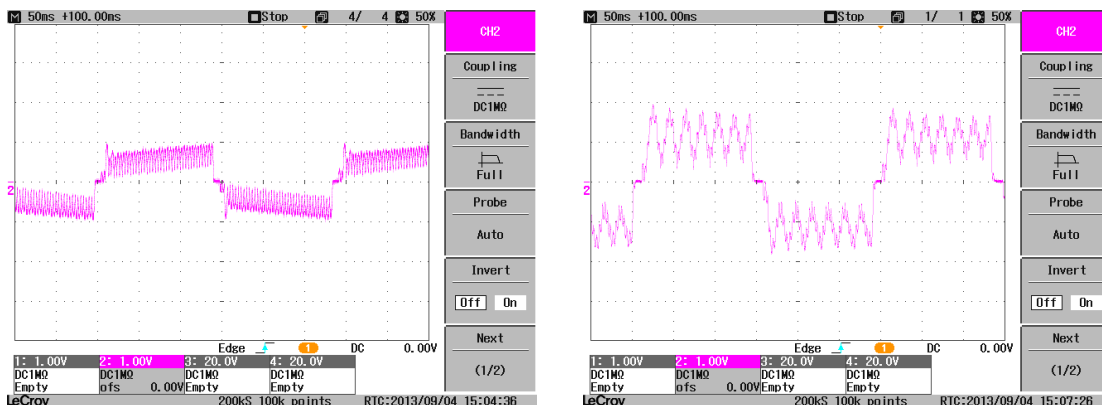

The left hand picture shows the effect of 94)Current Integral Gain being too low (and possibly 93)Current Proportional Gain too high).

The right hand picture shows the effect of 94)Current Integral Gain being too high and 93)Current Proportional Gain too low.

However, it is also possible to have a correct setting for 94)Current Integral Gain but induce instability during a prolonged period of constant current by an excessive setting of 93)Current Proportional Gain. It is therefore good practice to now increase the setting of 861)Square-Wave Half Period – for example to 300 - to check that there is no induced instability later in a half cycle. If instability is observed later in the half cycle the setting of 93)Current Proportional Gain should be reduced. Using a larger setting for 861)Square-Wave Half Period does mean that current will be made for a longer time in one direction, so care should be taken to avoid stressing the braking system unduly.

Having optimised the current loop response, 875)Min. Iarm Blanking Interval can now be reduced if necessary, a "dead time" of around 6 to 8ms is ideal, similar to the following:

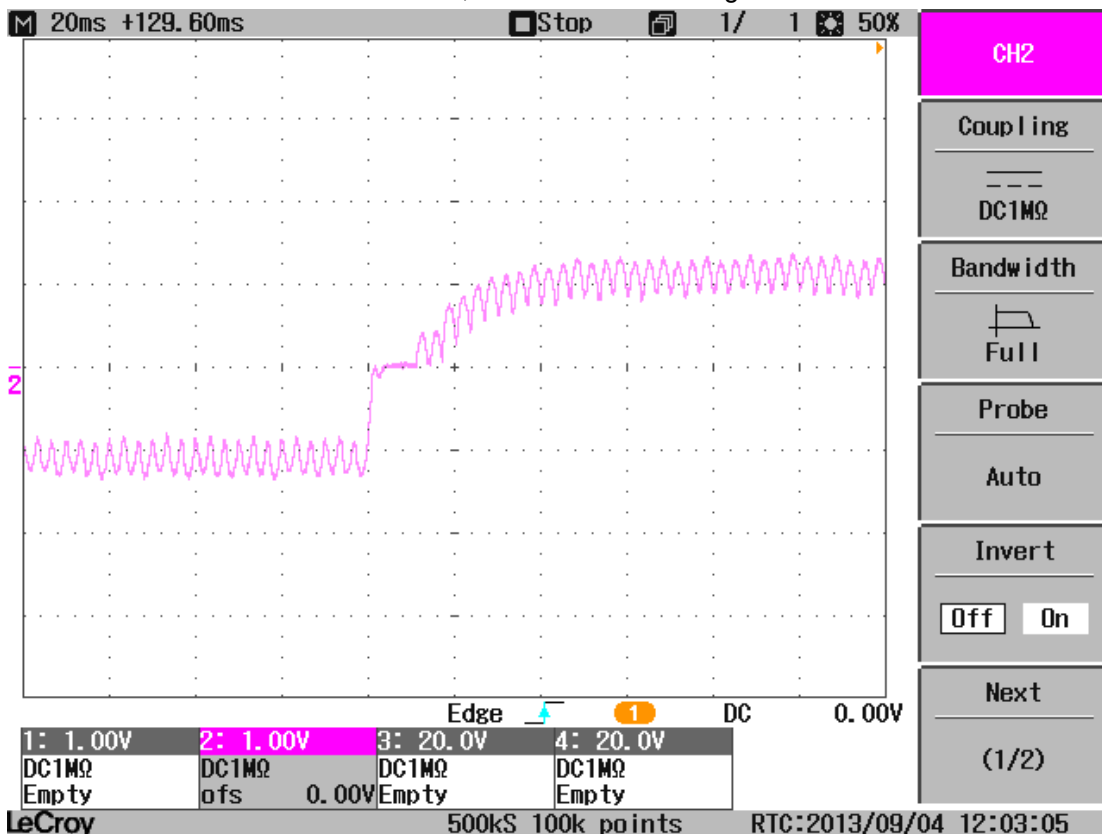

Stop the JL/X and return to normal running mode with 860)Stator Current Commissioning Mode set to Speed Control (Iarm COMMISSION.MODE set to 2, if adjusting via the JL/X MMI) and the braking system and DIO1,2,3,4 outputs returned to normal configuration.

#### 6.4.2 Speed loop tuning

During this procedure it will be necessary to observe three JL/X parameters: The speed demand, the speed feedback and the current demand. For the purposes of this document it has been assumed that a two channel oscilloscope is being used.

Navigate to the block diagram page containing the Run Mode Ramp block

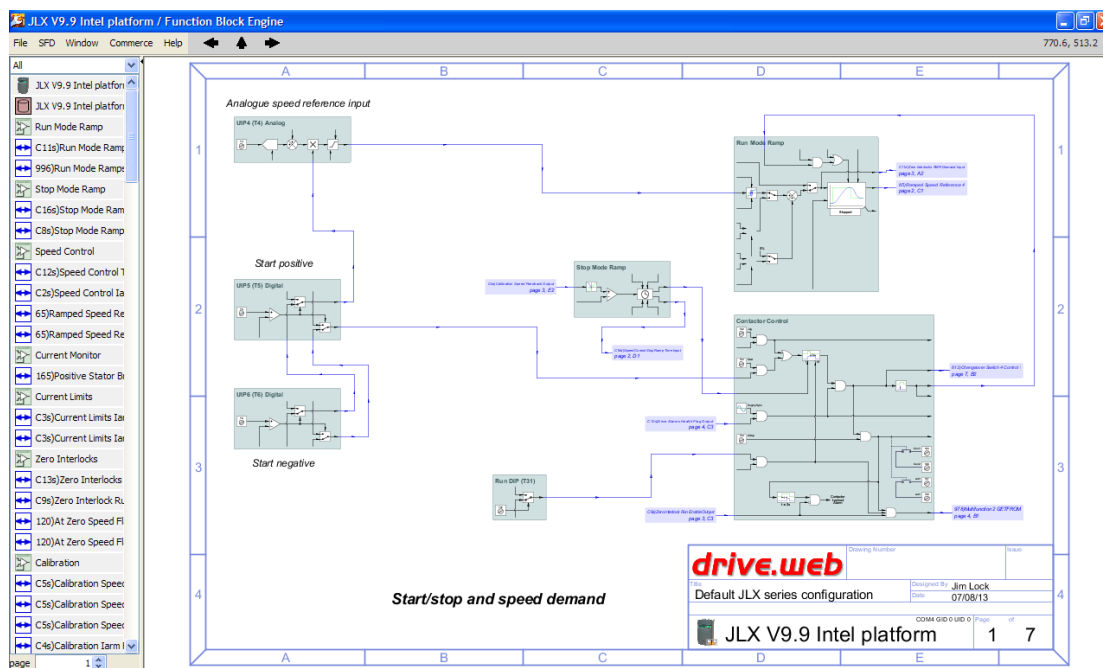

and left click on the Run Mode Ramp block



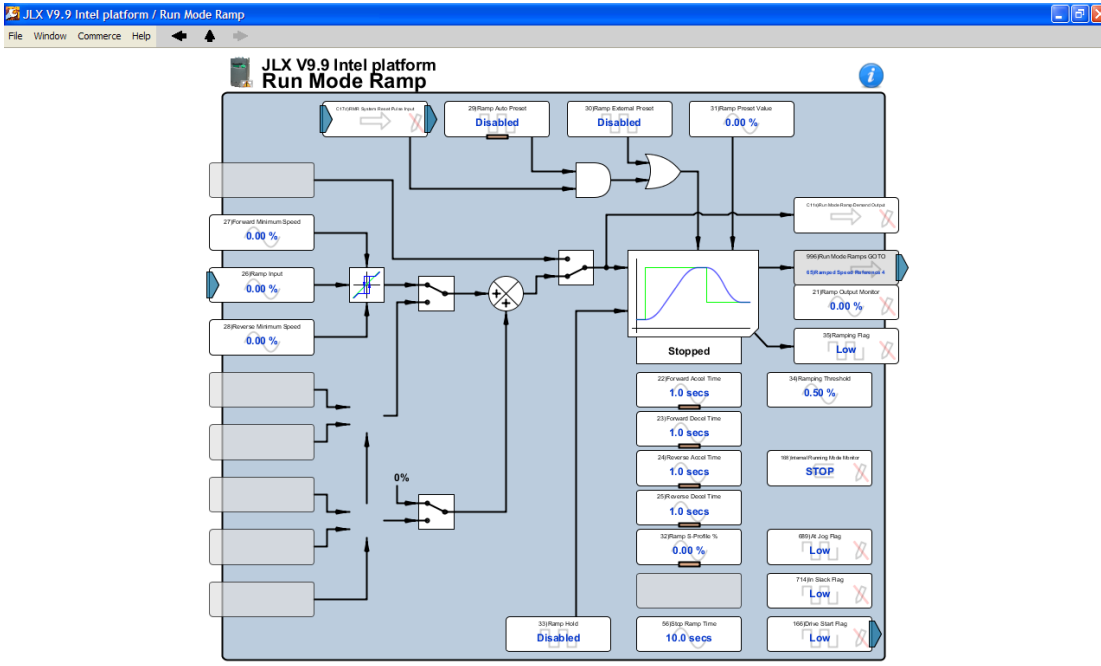

Set 22)Forward Accel Time, 23)Forward Decel Time, 24)Reverse Accel Time and 25)Reverse Decel Time to 0.1 seconds. 32)Ramp S-Profile % should be left at 0.00%.

Then navigate to the block diagram page containing the AOP blocks

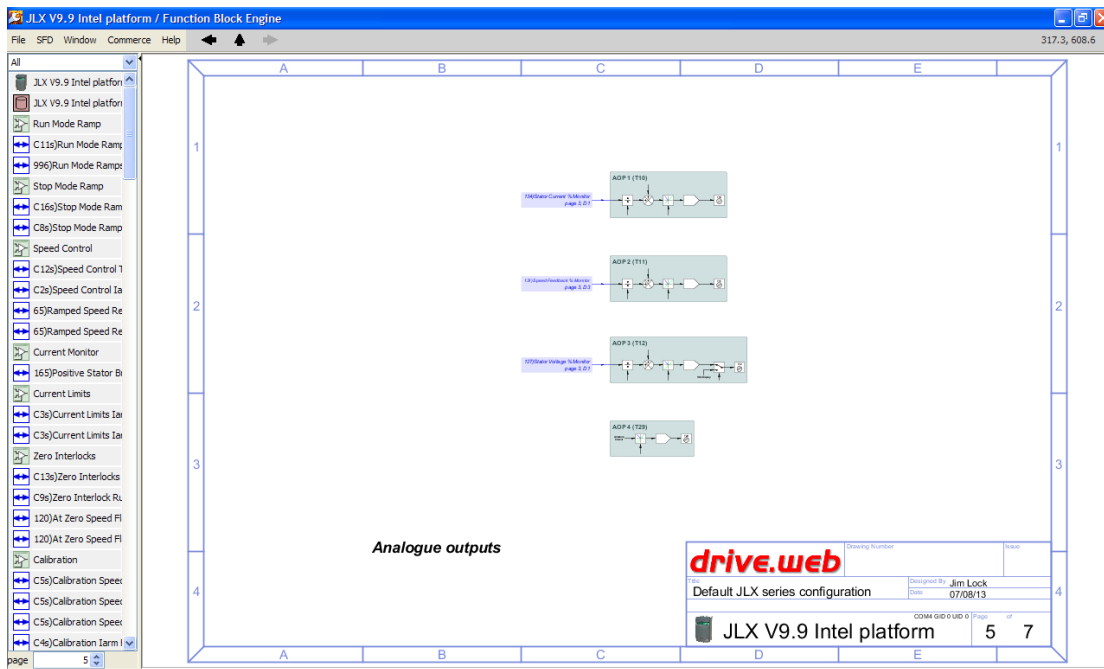

and left click on the AOP3 (T12) block.

## JLX V9.9 Intel platform AOP 3 (T12)

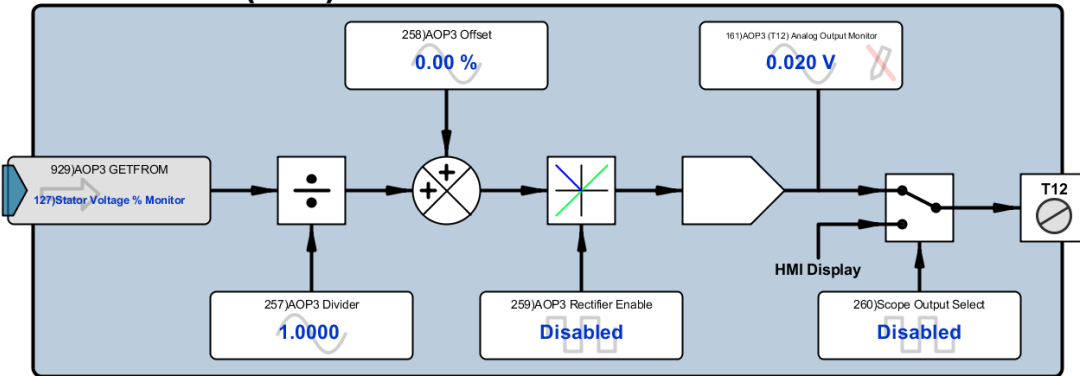

Delete the 929)AOP3 GETFROM connection and connect instead to 718)Unfiltered Current Demand Monitor. Also set parameter 257)AOP3 Divider to 2.0000.

The oscilloscope channels should now be connected to terminals 4 (channel 1) and 12 (channel 2). Start the JL/X and make small speed demand step changes – typically from 10 to 20 or 30% - whilst observing the oscilloscope. Determine a level of speed demand changes that is sufficiently large to allow speed response to be observed, but not large enough to force current demand (channel 2) to saturate at +7.5V (corresponding to 150% stator current). The two pictures below illustrate the method:

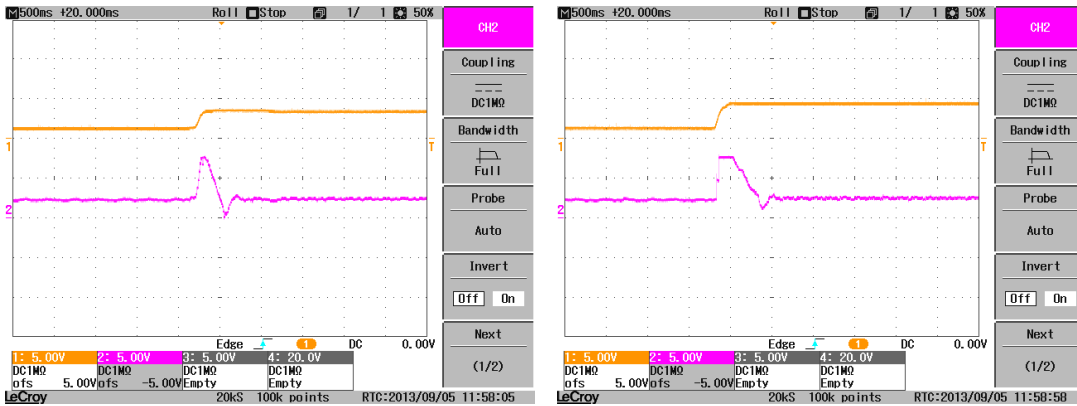

The picture on the left shows current demand peaking at about 150% which is acceptable. The picture on the right shows a larger speed demand step change forcing the current demand to saturate and clamp at 150%, which is not acceptable for speed loop tuning purposes.

Having established an appropriate level of speed demand step changes, stop the JL/X and return 257)AOP3 Divider to 1.0000. Also delete the 929)AOP3 GETFROM connection and connect instead to 715)Unfiltered Total Speed Feedback Monitor.

Start the JL/X and observe actual speed response to the previously determined speed demand step changes. A typical response is shown below, traces magnified for clarity.

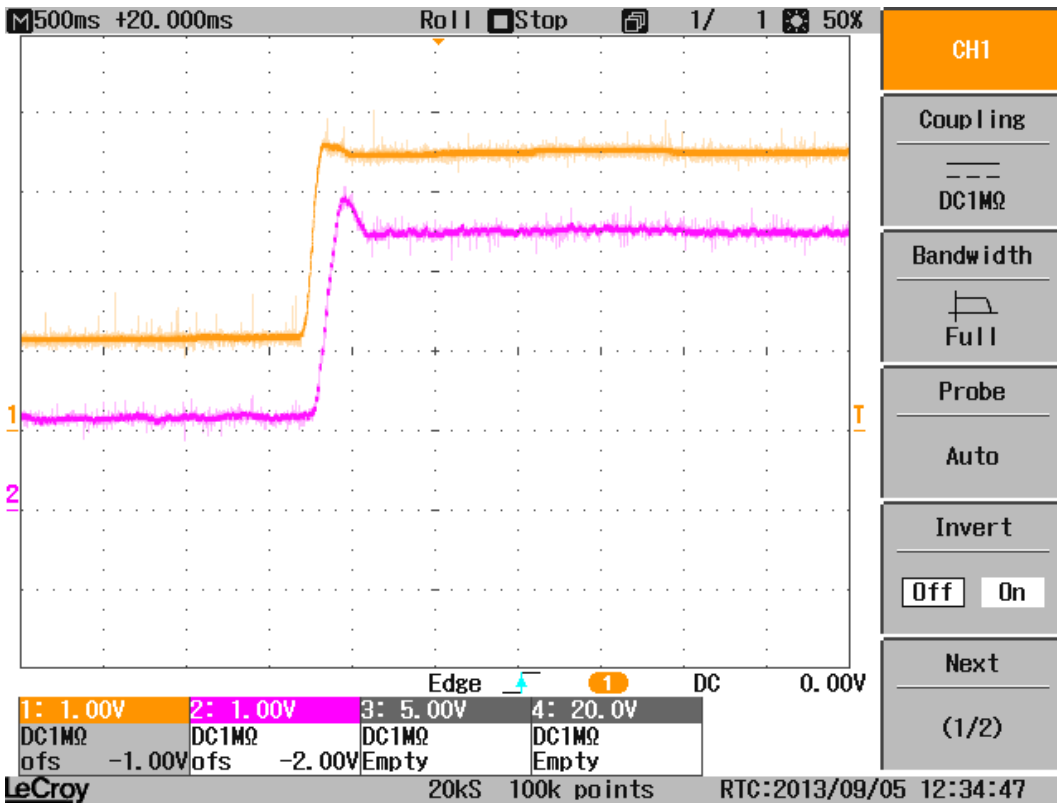

Navigate to the block diagram page containing the Speed Control block.

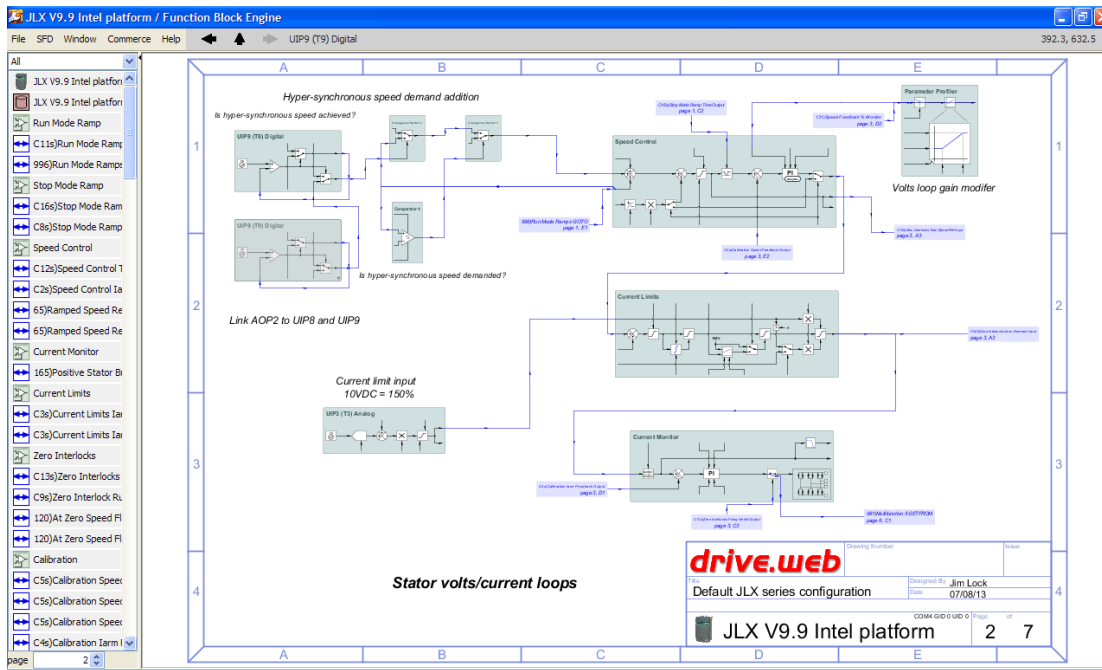

and left click on the Speed Control block.

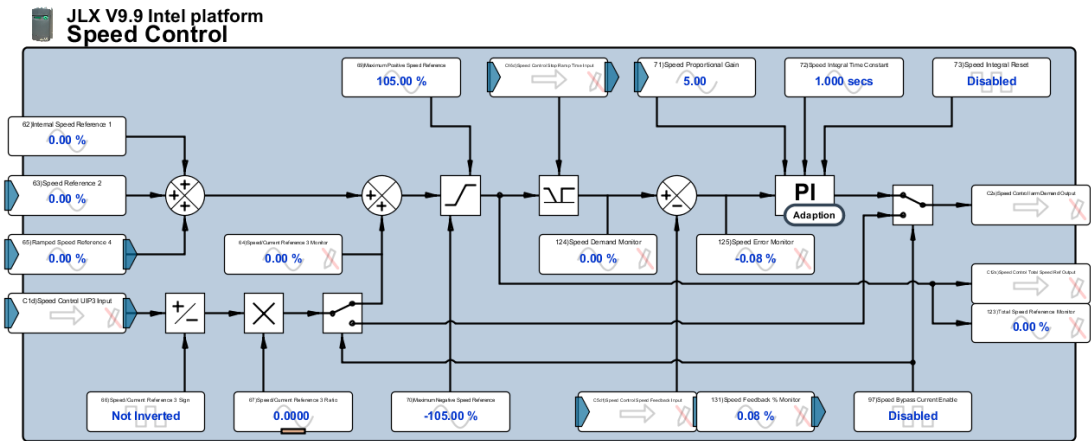

If necessary, reduce the value of 72)Speed Integral Time Constant so that the speed follows the step change in speed demand as closely as possible. Then return to the block diagram page containing the Speed Control block, left click on the Parameter Profiler block

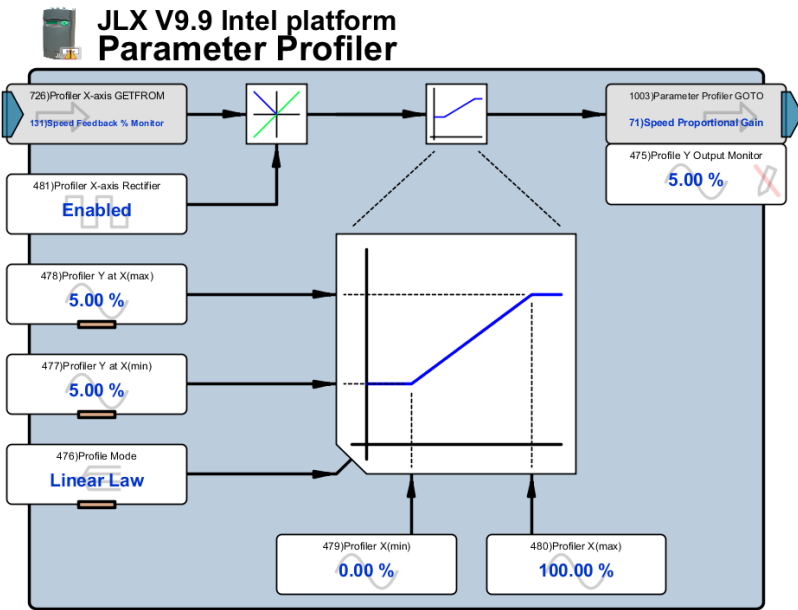

and increase both 477)Profiler Y at X(min) and 478)Profiler Y at X(max) values to damp out any overshoot observed. The following picture shows a correctly tuned speed loop.

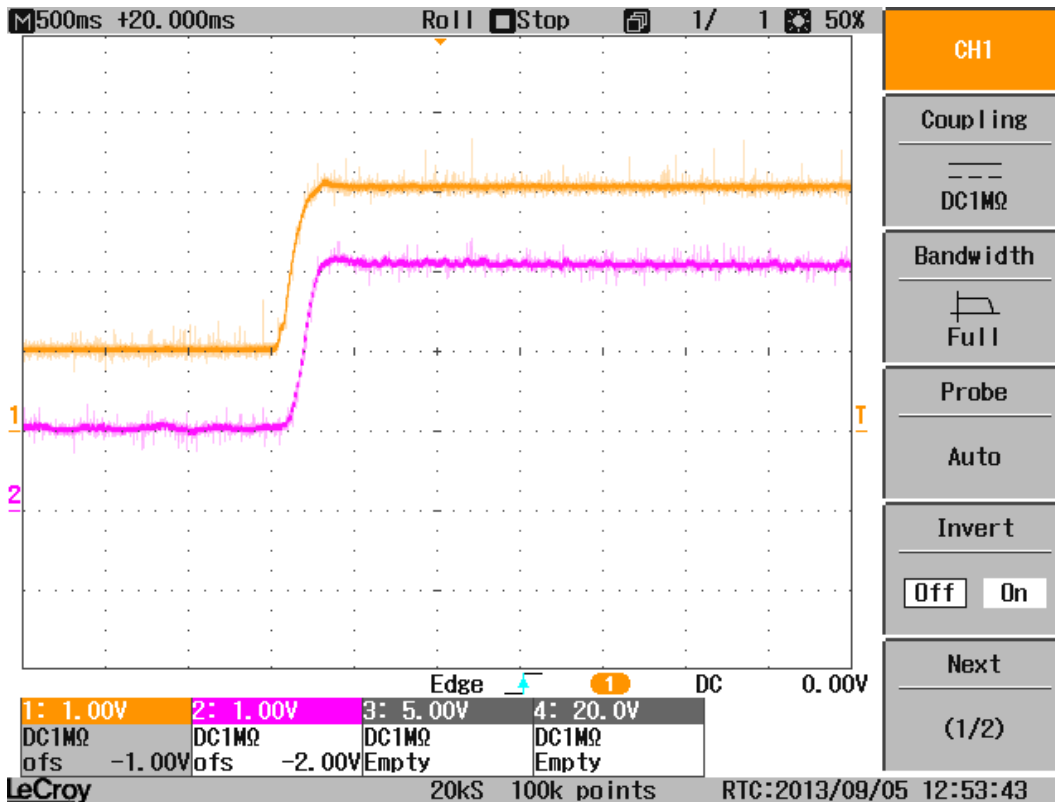

The Parameter Profiler block is used to set 71)Speed Proportional Gain. This is to make it possible to profile the speed loop gain against speed, in case of need. You are therefore now able to repeat the above steps using a step change from (for example) 60 to 80 or 90% speed and modify speed loop gain at higher speeds by adjusting 478)Profiler Y at X(max) independently of the speed loop gain at lower speeds, set by 477)Profiler Y at X(min), if necessary. 71)Speed Proportional Gain then automatically changes value linearly against speed between the two values set in 477)Profiler Y at X(min) and 478)Profiler Y at X(max).

Once speed loop tuning is complete, return to the AOP3 (T12) block.



### JLX V9.9 Intel platform AOP 3 (T12)

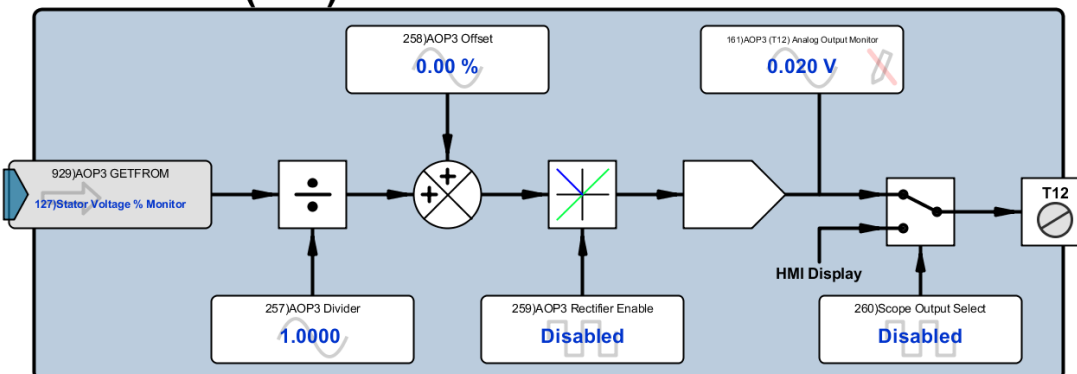

Delete the 929)AOP3 GETFROM connection, and connect it instead to 127)Stator Voltage % Monitor, which was its original configuration.

Return to the Run Mode Ramps block

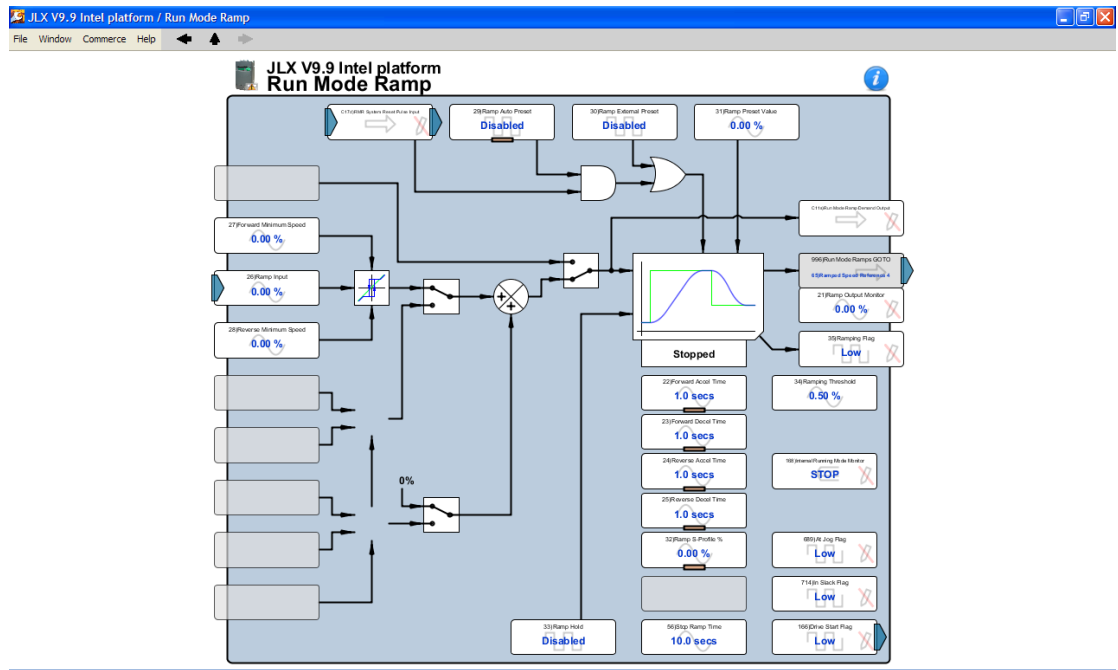

and restore any desired values in 22)Forward Accel Time, 23)Forward Decel Time, 24)Reverse Accel Time, 25)Reverse Decel Time and 32)Ramp S-Profile %.

Once all required parameters are set it is necessary to perform a PARAMETER SAVE. This can be done via the JL/X MMI in the normal way, or by right clicking on the JL/X icon within Savvy and selecting "Save All Parameters to EEPROM". It is also prudent to save a backup copy by using the Savvy "Export Device Data" function.

### 6.4.3 Special techniques for highly inductive stators

Highly inductive stators will require the JL/X to be put into a special mode. The parameter concerned is not adjustable using Savvy, and must be adjusted using the JL/X MMI. On the JL/X MMI, navigate to DISPLAY FUNCTIONS, PASSWORD CONTROL, ENTER PASSWORD and set to FEFA. Then navigate to the CONFIGURATION menu, which now contains the DRIVE RESERVED MENU. Enter this menu using the right key several times until the display reads Iarm COMMISSION.MODE on the bottom line. Use the up or down keys until the display bottom line reads 3-PHASE FIELD ENABLED. Use the right key then the up key to set this parameter to ENABLED.

Parameter 857)3-Phase Field Enable (the Savvy equivalent of the JL/X RESERVED MENU parameter) will then appear as Enabled in the Savvy Reserved Parameters screen.

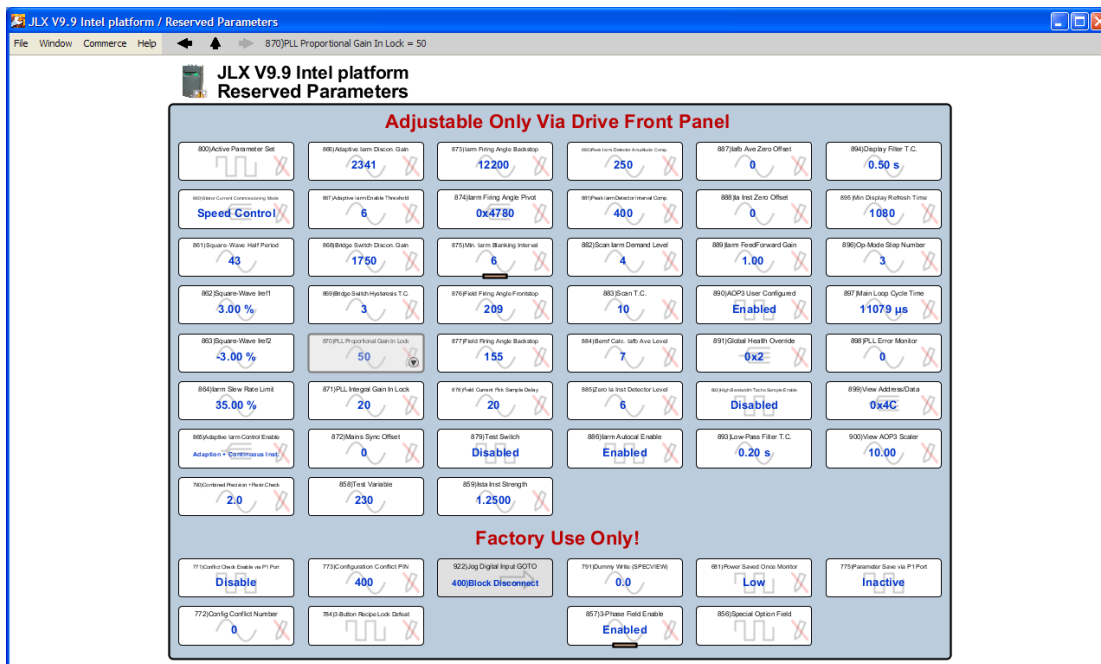

Setting this parameter to ENABLED has a \*10 scaling effect on 93)Current Proportional Gain – so that (for example) entering a value of 3 will result in an applied value of 30. It also disables INTERNAL ERROR CODE 0005 as this is inappropriate for very long time constant loads. It is also necessary with highly inductive stators to allow an extended “dead time” around zero current setting. To do this, navigate to the block diagram page containing the Current Monitor block

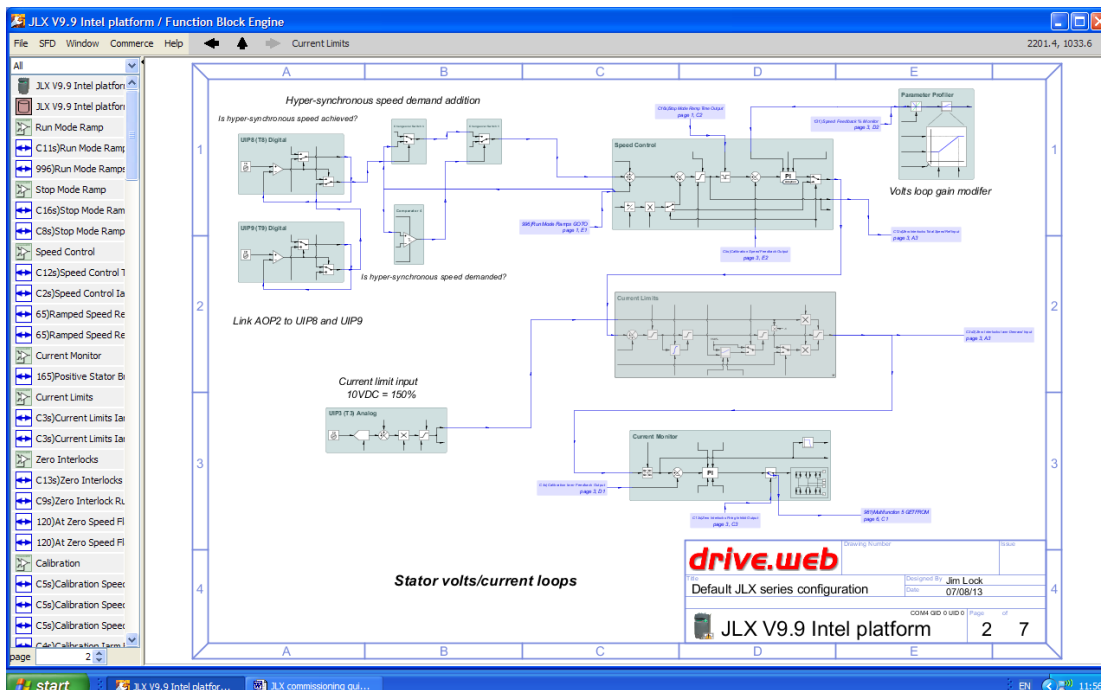

and left click on the Current Monitor block

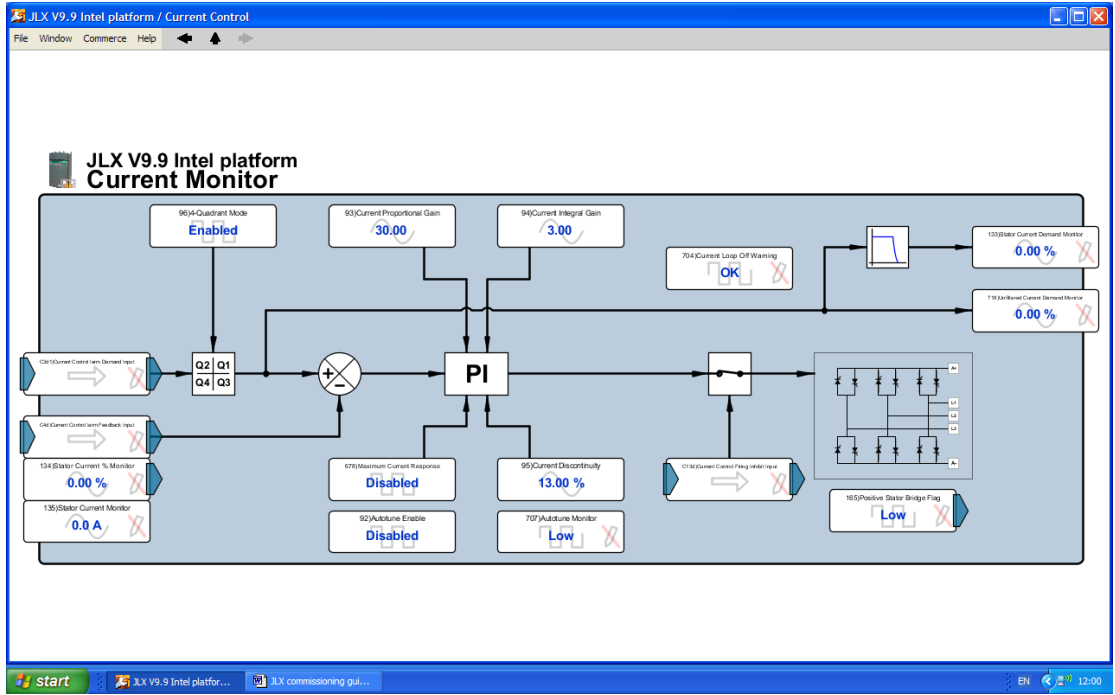

Set 678) Maximum Current Response to Enabled. It is now possible to set values up to 300 in 875) Min. Iarm Blanking Interval value.

The JL/X is now more suitable for use on a highly inductive stator, and the current and speed loop tuning can proceed as previously described in sections 6.4.1 Current loop tuning (remembering that values entered for 93) Current Proportional Gain will be subject to a \*10 scaling factor) and 6.4.2 Speed loop tuning.

## 7 Alarms

**Important note:** All alarms are generated with semiconductor electronics. Local safety codes may mandate electro-mechanical alarm systems. All alarms must be tested in the final application prior to use. The manufacturers and suppliers of the JL/X are not responsible for system safety.

The available alarms can be displayed by navigating to the block diagram page containing the Drive Alarms block

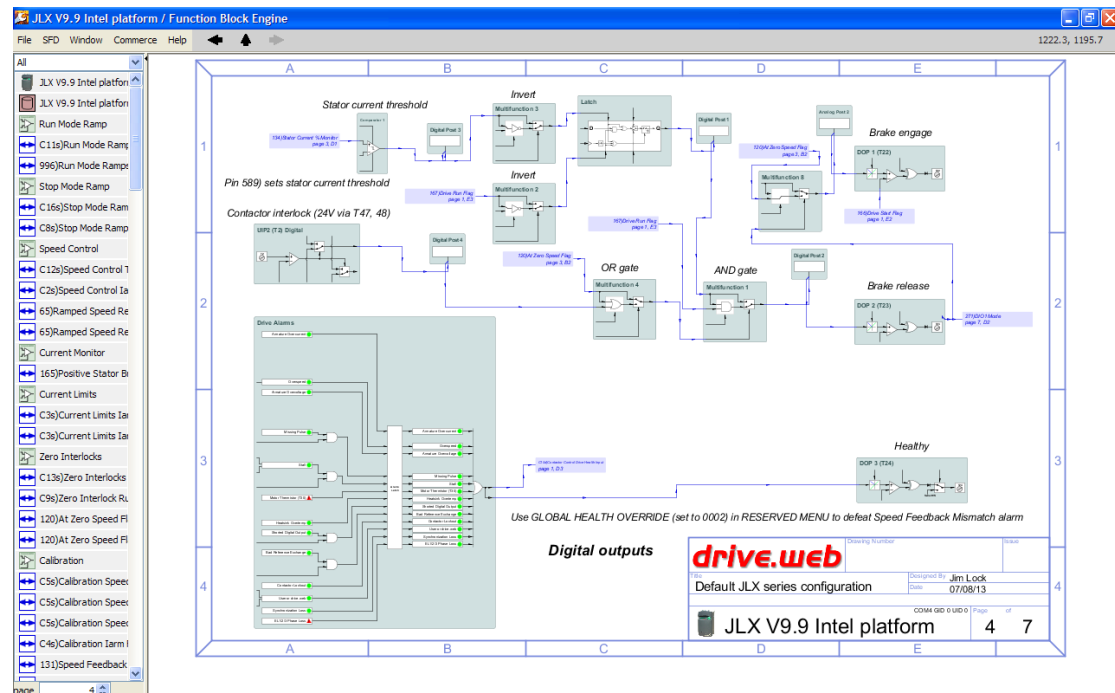



and left clicking on the Drive Alarms block.

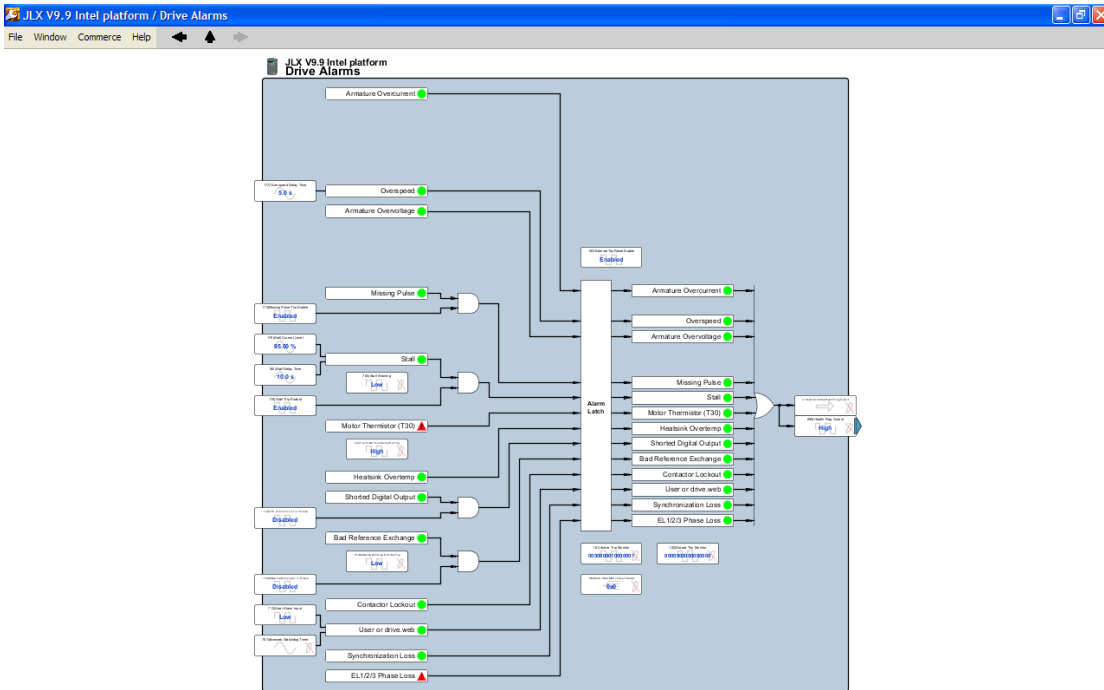

The alarms available on the JL/X are as follows:

### 7.1 Stator Overcurrent

This is an instantaneous alarm, which will trip the JL/X at between 300 and 400% of maximum model rating to protect against stator shorts to earth, incorrect phase relationship between the L and EL terminals etc. This alarm cannot normally be disabled and is not intended to act as a substitute for correctly rated external semiconductor fusing.

### 7.2 Overspeed

If the speed feedback monitor exceeds 110% of rated speed as set by 6)Desired Maximum RPM for longer than the delay time, the JL/X will trip. The delay time is approximately 0.5 seconds plus the value set in 177)Overspeed Delay Time. The default value is 5 seconds. This may be caused by poorly adjusted speed loop parameters or an overhauling load in the case of JL models. This alarm cannot normally be disabled.

### 7.3 Stator Overvoltage

If the measured Stator volts exceeds the value set in 18)Stator Maximum Voltage by more than approximately 20% for longer than approximately 1.5 seconds the JL/X will trip. This alarm cannot normally be disabled.

### 7.4 Missing pulse

This is a timed alarm. The Stator current waveform is continuously monitored by the JL/X. If a fault develops within the JL/X firing or thyristor bridge it is possible that one or more current pulses may be missing from the Stator current waveform. Although the JL/X may appear to function normally, the motor may experience a heating effect and the three phase supply currents will become unbalanced. If at least one current pulse is missing and the average Stator current is above the level set in 95)Current Discontinuity the system will start to count missing pulses. The JL/X will trip after a sequential series of missing pulses lasting approximately 30 seconds. This alarm is enabled by default but may be disabled by setting 117)Missing Pulse Trip Enable to Disabled. In an otherwise healthy JL/X this alarm can be caused by large amounts of speed feedback ripple or a poorly adjusted speed or current loop. The alarm may be temporarily disabled whilst investigating such causes.

## 7.5 Stall

This is a timed alarm. Stator current is continuously monitored by the JL/X. If the rotor speed is below the threshold set by 117)Zero Interlocks Speed Level and the stator current is higher than the threshold set by 179)Stall Current Level for longer than the period set in 180)Stall Delay Time the JL/X will trip.

## 7.6 Motor Thermistor (T30)

This is a timed alarm. It is good practice to protect motors against sustained thermal overloads by fitting temperature sensitive resistors or switches in the windings of the machine. Temperature sensitive resistors have a low resistance (typically 200 Ohms) up to a reference temperature (125 deg C). Above this, their resistance rises rapidly to greater than 2000 Ohms. Temperature switches are usually normally closed, opening at about 105 deg C.

Any sensors fitted should be connected in series between terminal 30 and terminal 36. If the motor temperature rises such that the resistance of the sensor exceeds 1800 Ohms, the JL/X will trip after approximately 15 seconds.

This alarm cannot normally be disabled. Terminals 30 and 36 must be linked if over-temperature sensors are not used.

## 7.7 Heatsink Overtemp

All JL/X models are fitted with heatsink cooling, two fans in the case of the frame 2 models JL/X130 – 270 and JL/XHD75 – 160, one fan in the case of the frame 4 models JL/X370 – 1680 and JL/XHD220 – 1010 and two fans in the case of the frame 5 models JL/X860 – 1680 and JL/XHD520 – 1010.

Frame 2 models JL/X130 – 270 and JL/XHD75 – 160 are fitted with a single heatsink temperature sensor.

Frame 4 models JL/X370 – 780 and JL/XHD220 – 470 are fitted with a single heatsink temperature sensor.

Frame 5 models JL/X860 – 1680 and JL/XHD520 – 1010 are fitted with two heatsink temperature sensors.

The cooling fan(s) should operate whenever the JL/X is running. In the event of fan failure, or restriction of the cooling airflow, the heatsink temperature may rise to an unacceptable level, approximately 100 degrees C adjacent to the heatsink temperature sensor(s). Under these conditions, the JL/X will trip after approximately 0.75 seconds. The fans and cooling air path should be checked for obstructions.

In the case of the frame 2 models JL/X130 – 270 and JL/XHD75 – 160 the fan supply is generated internally.

Frame 4 models JL/X370 – 780 and JL/XHD220 – 470 require a 240VAC 100VA fan supply on terminals B1, B2.

Frame 5 models JL/X860 – 1680 and JL/XHD520 – 1010 require a 240VAC 200VA fan supply on terminals B1, B2.

In the case of frame 4 and 5 models JL/X370 – 1680 and JL/XHD220 – 1010 the alarm will also operate if the fan supply on terminals B1, B2 falls below approximately 150VAC.

This alarm cannot normally be disabled.

## 7.8 Shorted Digital Output

All digital output (terminals 18 – 24) and the nominal 24V user supply (terminal 35) have been designed to withstand a direct short circuit to 0V. If this happens, an internal alarm is raised. The remaining digital outputs are also disabled resulting in a low output. (Short circuit current is approximately 350mA for digital outputs and 400mA for the nominal +24V user supply).

If the alarm is disabled and the shorting fault has not interrupted the drive running normally, then the JL/X will continue to run. Note, if any digital output is shorted the +24V terminal T35 will remain active with a capability of 50mA. If the +24V output is shorted then all digital outputs will also go low and this alarm is activated. In this case if the +24V is being used to enable CSTOP or START then the drive will stop.

This alarm is enabled by default, it may be disabled by setting 174)DOP Short Circuit Trip Enable to Disabled.

## 7.9 Bad Reference Exchange

The JL/X can transmit and receive a speed reference or other parameter to or from another JL/X using the serial port. During the receive cycle checks are made that the data received is valid. If the data received is invalid then an alarm is raised. This is a timed alarm with a 1.5 second delay.

This alarm is only applicable if the JL/X serial port 188)PORT1 FUNCTION has been set to REF EXCH SLAVE, for example in a load sharing application.

This alarm is disabled by default but may be enabled by setting 176)Ref Exchange Trip Enable to Enabled.

## 7.10 Contactor Lockout

This alarm will occur in two circumstances:

- 1) If the 3 phase supply on EL1/2/3 is of insufficient quality to allow the synchronisation circuit to measure its frequency and/or phase rotation, or
- 2) The JL/X has an interlock function that prevents start unless the external speed reference is set to zero. This function is enabled by 116)Zero Reference Start Enable (the default for this parameter is Disabled). If 116)Zero Reference Start Enable has been set to Enabled and start is requested without reducing the external speed demand to zero.

If either circumstance arises the JL/X will trip after approximately 3 seconds.

This alarm cannot normally be disabled.

## 7.11 User or drive.web

Parameter 712)User Alarm Input may be connected to a spare digital input or any chosen flag, for example 704)Current Loop Off Warning, to induce an alarm in a specific circumstance. The JL/X will trip when this alarm is taken high, there is an approximate 0.5 second delay on this alarm. By default 712)User Alarm Input is set to Disabled.

If a drive.web card is fitted to the JL/X, the drive.web card watchdog timer is logically ORred with this alarm.

This alarm cannot normally be disabled.

## 7.12 Synchronization loss

The JL/X automatically synchronizes to any 3-phase supply within a frequency range of 45 to 65 Hertz ensuring that the JL/X bridge thyristors are fired at the correct instant during each supply cycle. The JL/X takes approximately 750 milliseconds to synchronize from the moment of application of the EL1/2/3 supply and will track the supply frequency thereafter. If the standard power connection configuration is adopted with EL1/2/3 permanently connected then the synchronization commences during the first application of a supply to EL1/2/3. This allows the main supply contactor to be operated very rapidly with minimal start up delay if required. Power connection configurations that involve application of the EL1/2/3 supply coincident with operation of the main supply contactor will result in a 0.75 second delay before running following closure of the main supply contactor.

If the supply frequency falls outside the specified limits, or if the JL/X is supplied from a power supply which has excessive distortion, the JL/X will trip.

**Important note:** This alarm is monitored whilst running. If there is failure to achieve synchronization at start, then the alarm 7.10 Contactor Lock Out will operate instead.

## 7.13 EL1/2/3 Phase Loss

The JL/X continuously monitors the incoming supply of the EL1 and EL2 connections. EL3 is monitored only at the instant of starting the JL/X. The threshold for loss detection is 75% of the value entered in parameter 19)EL1/2/3 Rated AC Voltage.

If the JL/X is running at the time of supply loss detection then the JL/X will trip after a ride through time of 2 seconds has elapsed. If the supply is restored before the ride through time has elapsed then normal running will resume.

During the temporary supply loss period the JL/X will shut the stator current demand off until it is safe to restore current.

If the JL/X is not started at the time of supply loss detection then a start command will allow the contactor to energise but inhibit stator current. In this circumstance the JL/X will trip after approximately 3 seconds.

This alarm cannot normally be disabled, but may be de-sensitised if necessary by reducing the value of 19)EL1/2/3 Rated AC Voltage.

#### 7.14 Special note concerning speed feedback mismatch alarm

The speed feedback mismatch alarm function (for detecting tachogenerator or encoder speed feedback failure) is carried forward from the PL/X range of dc controllers from which the JL/X is derived. Current versions of the JL/X (V1.23 JL/X software) have no means for sensing tachogenerator or encoder speed feedback loss.

It is therefore necessary to override the speed feedback mismatch alarm in the JL/X RESERVED MENU. This setting is currently made by default – GLOBAL HEALTH OVERRIDE set to decimal value 2.

If tachogenerator or encoder failure detection is required it must be externally implemented.

Rotor speed detection using rotor zero crossing frequency measurement is planned for future JL/X versions, allowing the speed feedback mismatch alarm to be implemented internally.

# 8 Mechanical Dimensions

## 8.1 Frame 2 JL/X130 – 270 and JL/XHD75 - 160

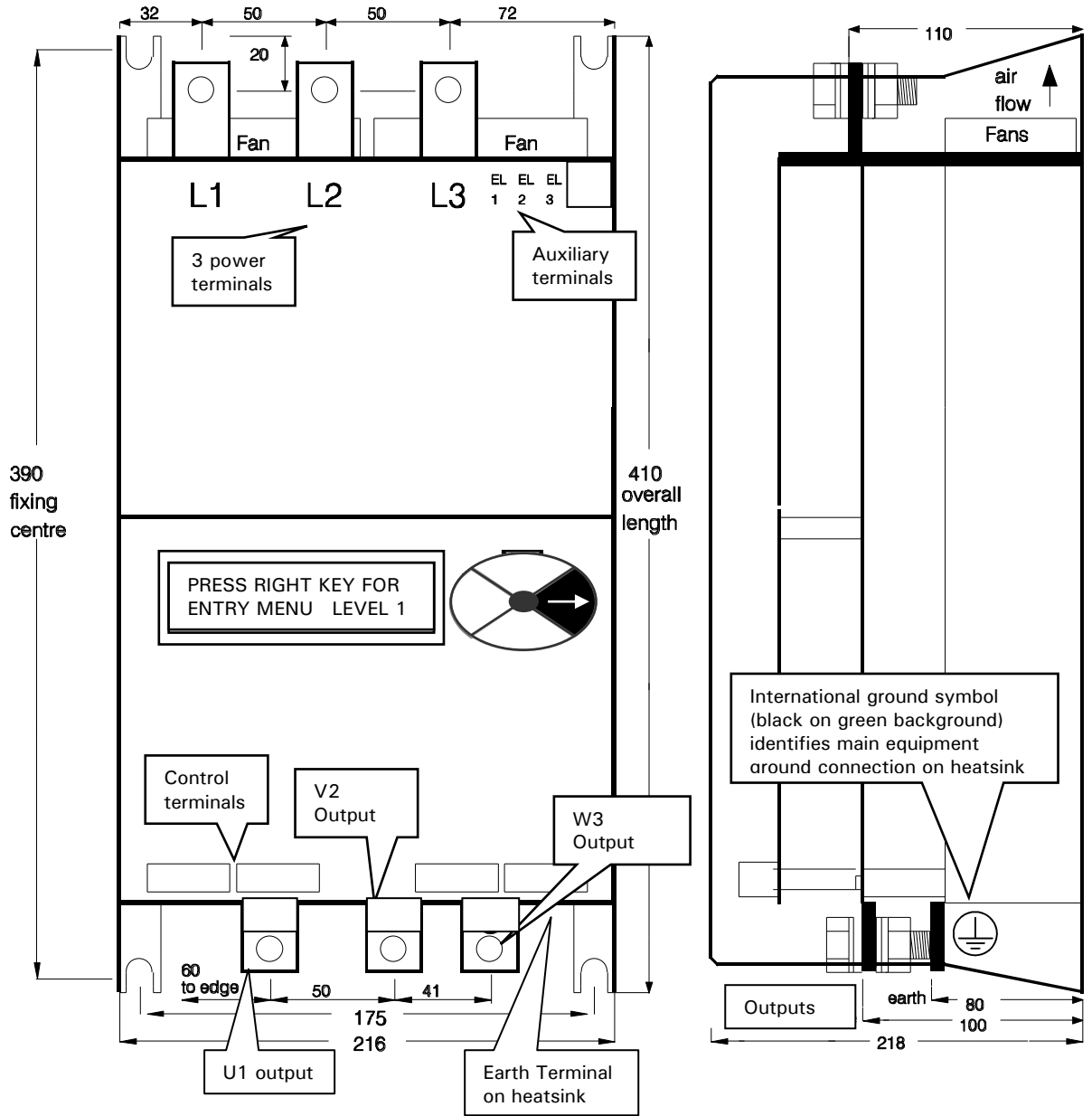

Weight 15Kg

## 8.2 Frame 4 JL/X370 – 780 and JL/XHD220- 470

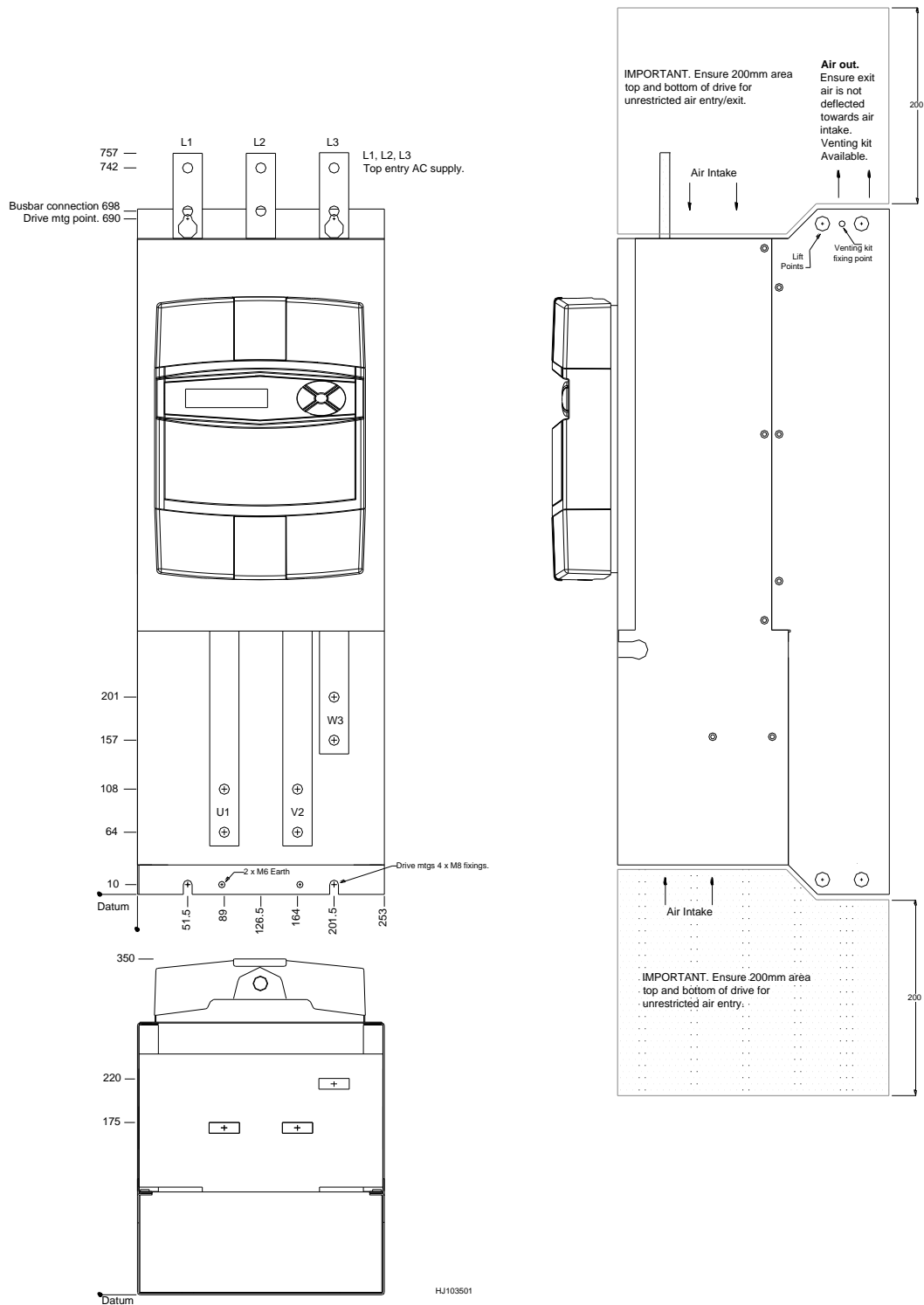

Weight 45Kg

### 8.3 Frame 5 JL/X860 – 1680 and JL/XHD520 - 1010

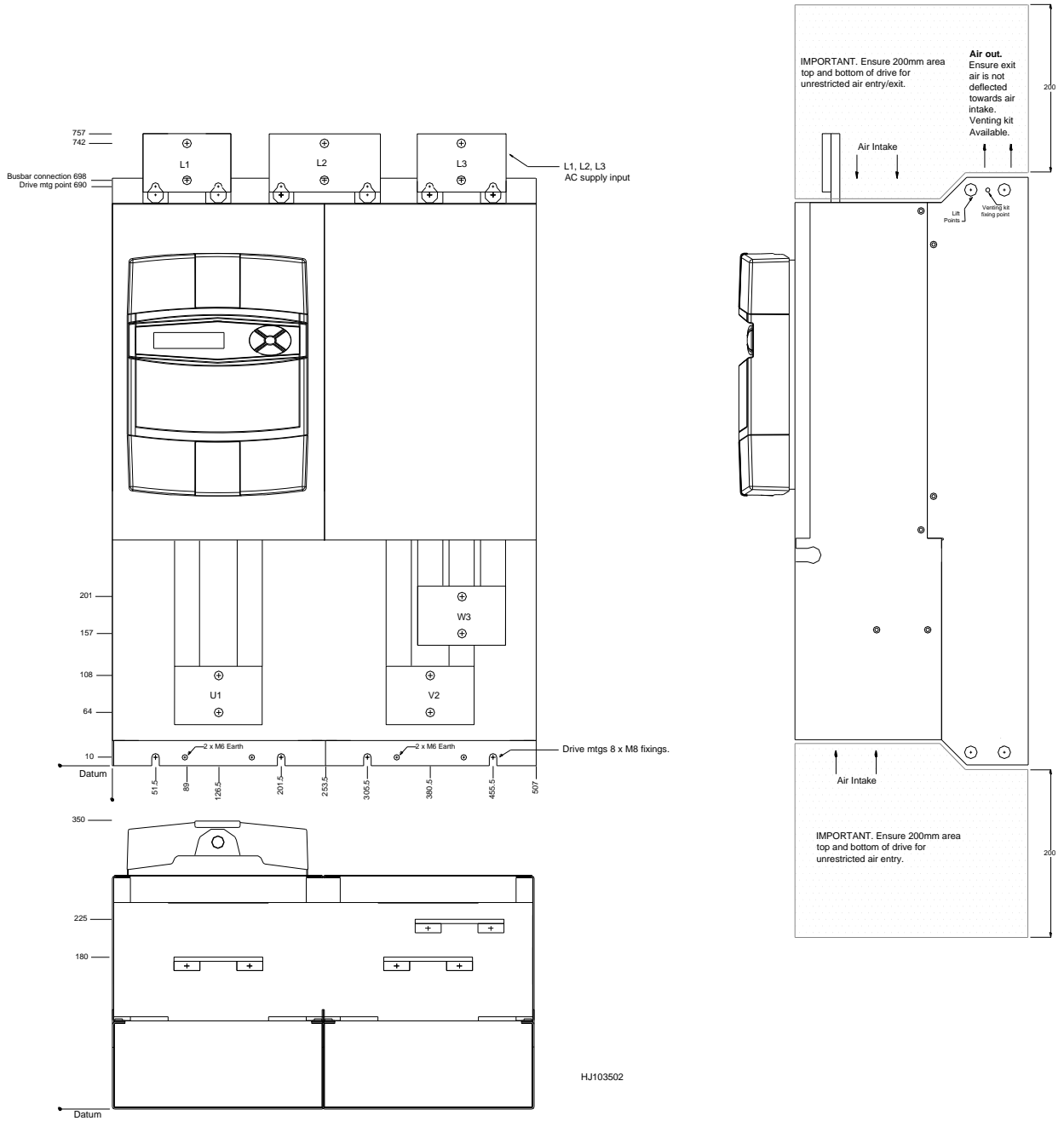

Weight 90KG.

## 9 Venting

### 9.1 General venting information for frame 4 and 5

In order to keep these units within the required operating temperatures under all operating limits they are equipped with a very efficient cooling system. It consists of a powerful centrifugal fan system integral to the unit mounted at the bottom, which blows air over a high dissipation heatsink. Cool air is drawn in both at the top and bottom of the unit and after travelling over the internal heatsink fins, is exhausted at the top of the unit. See 9.6 Air supply to enclosure. From here the warm air must be vented from the enclosure used to house the JL/X. The unit will run cooler and hence be less stressed if the warm exhaust air is prevented from mixing with the intake air. This can be achieved by the use of the optional venting kit. See below.

### 9.2 When venting kit impractical for frame 4 and 5

For these models it is necessary to keep the exhaust air that is emitted from the top end of the fin section separated from the rest of the enclosure by constructing a duct that can evacuate the exhaust air from the enclosure. If this requires an indirect route then you may need to use external fans to maintain the required airflow. See 10 Product rating table for airflow requirements. Ensure pollutants cannot enter the port and a suitable grille must be used if there is a danger of birds or vermin entering.

### 9.3 Venting kit for frame 4

The venting kit comprises two steel ducts which are designed to telescope together. Hence the duct length from the top of the JL/X is adjustable between 270mm to 538mm. It consists of three main components.

- 1) A lower duct, which fits within the side cheeks directly above the heatsink exhaust area.

This is secured with 2 M5 screws. See 6 for fixing point drawing. The lower duct is 270mm long from the top edge of the JL/X.

- 2) The upper duct, which fits over the lower duct section, to extend the total length of the assembly.

It has a series of M5 side holes to allow adjustment. Once the desired height is established the upper duct can be screwed to the lower duct through the selected hole, one screw per side. The useful length of the extended duct may be adjusted in steps of approx. 20mm from 270mm to 535mm. The duct must be inserted through a tight fitting rectangular hole in the roof of the enclosure (hole size 100mm x 252mm) and protrude above it by 10-20mm. Then the gap between the duct and the enclosure roof must be sealed (e.g. using tape or flexible filler) to ensure that the exhaust air and pollutants cannot enter into the enclosure.

- 3) A cowl, which is fixed on top of the enclosure to prevent pollutants from dropping into the outlet.

The cowl is supplied with 4 off 50mm mounting pillars, and 4 M6 holes must be drilled in the roof of the enclosure, to allow the mounting pillars to be fixed such that the cowl is positioned centrally over the duct. The cowl will overhang the duct by 70mm all the way round. If there is a danger of birds or vermin entering the exhaust port then it is recommended that a suitable grille is added round the edge of the cowl.

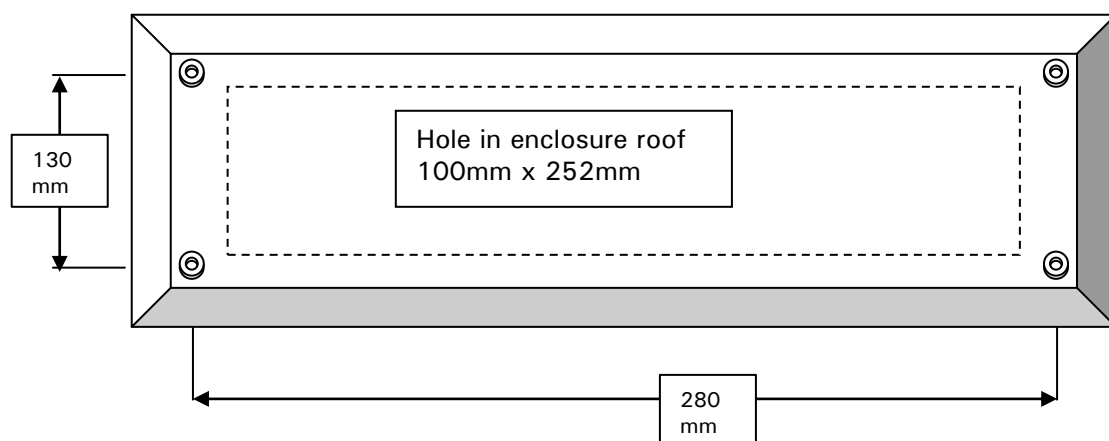



#### 9.4 Frame 4 and 5 venting kit diagram

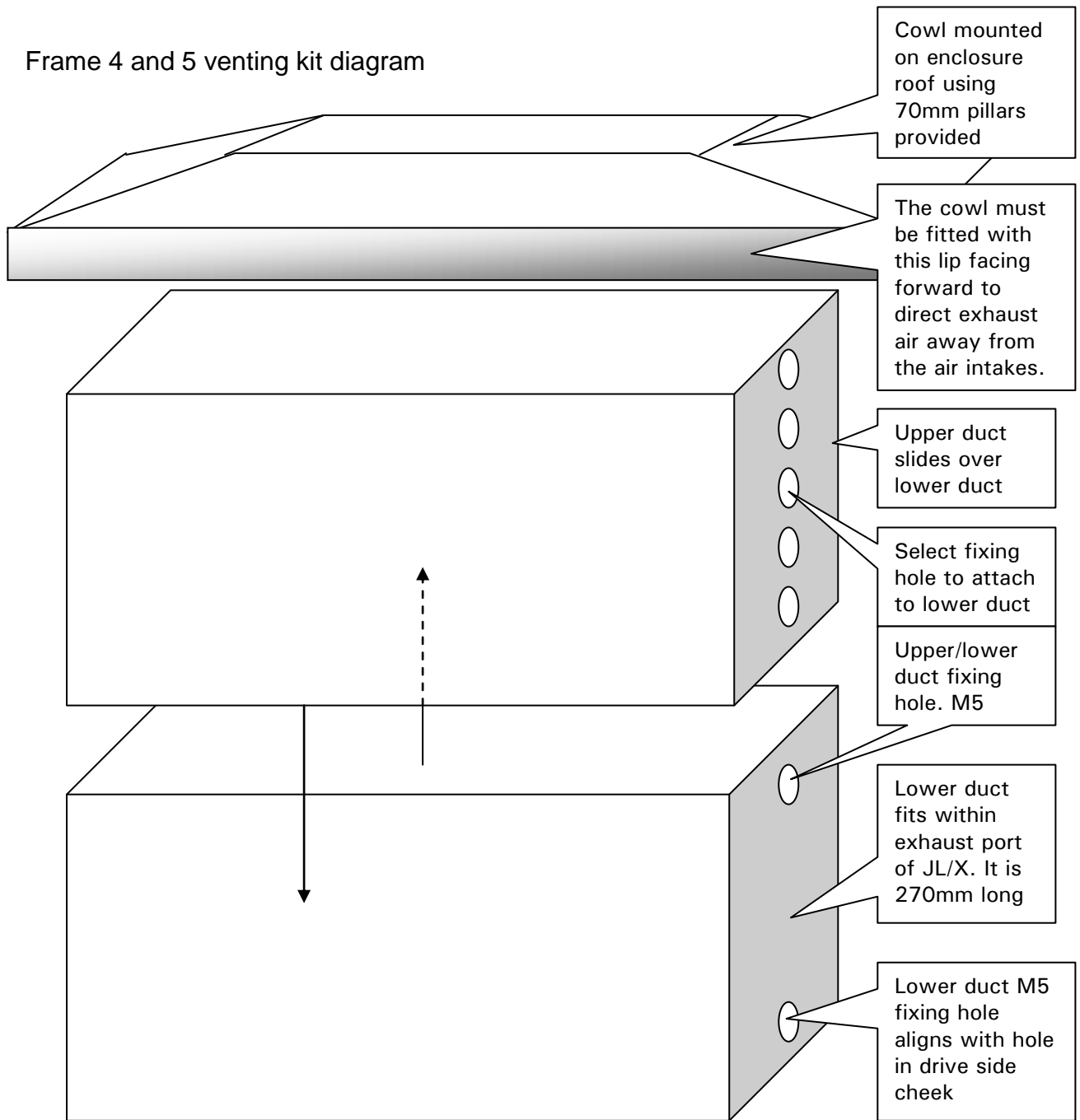

#### 9.5 Venting kit for frame 5

The venting kit comprises a cowl and 2 pairs of steel ducts, each pair being designed to telescope together. Hence the duct length from the top of the JL/X is adjustable between 270mm to 535mm. There is also an enclosure roof cowl. Each pair is the same unit as described in 9.3 Venting kit for frame 4. There are 2 exhaust ports at the top of the JL/X and each pair of ducts is used with one of the ports. Please read section 5.2 for details about each pair.

The ducts must be inserted through a tight fitting rectangular hole in the roof of the enclosure (hole size 100mm x 504mm) and protrude above it by 10-20mm. Then the gap between the duct and the roof must be sealed (e.g. using tape or flexible filler) to ensure that the exhaust air and pollutants cannot enter into the enclosure. Also the interface between each pair of ducts must be sealed at the top where it protrudes from the roof.

The cowl is fixed on top of the enclosure to prevent pollutants from dropping into the exhaust outlet of the JL/X. The cowl is supplied with 6 off 50mm mounting pillars, and 6 M6 holes must be drilled in the roof of the enclosure, to allow the mounting pillars to be fixed such that the cowl is positioned centrally over the duct. The cowl will overhang

the duct by 70mm all the way round. If there is a danger of birds or vermin entering the exhaust port then it is recommend that a suitable grille is added round the edge of the cowl.

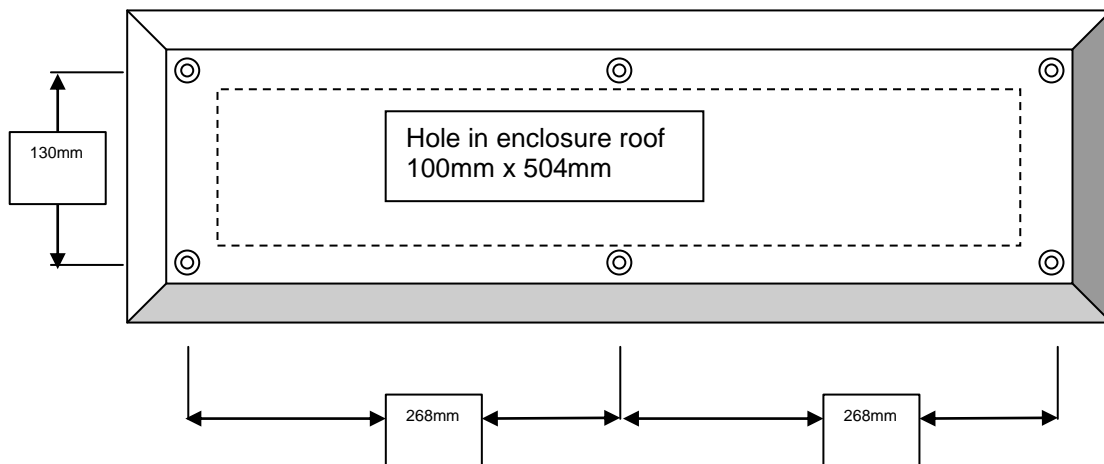

## 9.6 Air supply to enclosure

It is essential that the enclosure which houses the JL/X is supplied with sufficient cool clean air to satisfy the throughput requirements of the JL/X and any other devices within the enclosure. Do not forget that the current carrying components associated with the JL/X will be dissipating a considerable amount of heat especially when the system is running at full capacity.

The enclosure must be fitted with air filters suitable for the airbourne pollutants encountered within its environment. Together they must have a rated throughput of sufficient capacity for all of the exhaust fans used in the enclosure. If the JL/X is fitted with a venting kit and there is another exhaust fan also operating for cooling other components it is essential that the auxiliary fan does not starve the JL/X of its air supply. This should be avoided if the input filters have sufficient capacity. It is recommended that the JL/X is provided with its own filters, and an enclosure partition used to isolate it from the influence of the rest of the enclosure cooling arrangements.

There should be 2 filters for the JL/X. One to provide air to the lower input port, and one for the upper port. The inlet filters should be fitted to the enclosure adjacent to the input ports at the lower and upper ends of the unit to ensure that the air drawn in is close to where it is needed. The reason for using filters at the top and bottom of the unit is because if only one filter is provided, then when the enclosure door is shut, the airpath from top to bottom may become throttled if the door is close to the face of the unit.

## 9.7 Exhaust air

After leaving the enclosure containing the JL/X the heated exhaust air will need to be prevented from elevating the ambient temperature of the room that is housing the enclosure by using sufficient ventilation. Alternatively the supply of cooling air may be obtained from outside and ducted to the enclosure.

## 9.8 Venting summary

Ensure a clean un-interruptible supply of cool filtered air is available for the JL/X and that the exhaust air is adequately and safely disposed of. Use the venting kit to keep the hot exhaust air separate from the cooling input air within the enclosure. Ensure the cooling air is available at the top and bottom of the unit. The JL/X will survive running at high ambient temperatures but possibly at the expense of its potential lifespan. Observe good engineering practice and keep all the components within the enclosure as cool as possible, consistent with avoiding condensation. For installations subjected to high ambient temperatures consider the use of air conditioning to achieve these requirements.

### 9.9 Diagram of airflow for frame 4 and 5

This diagram shows a side view of a unit in an enclosure. This is the recommended method for arranging the flow of cooling air. The fan in the JL/X will draw air into the top and bottom air intakes of the unit.

Two air inlet filters should be mounted on the door. One adjacent to the lower air intake of the unit and the other adjacent to the upper air intake of the unit.

The exhaust air is exiting the enclosure via the venting kit assembly which is shown with the cowl fitted on the roof of the enclosure.

If this hot exhaust air is likely to raise the temperature of the air being drawn in, then further measures must be taken to direct it away from the system.

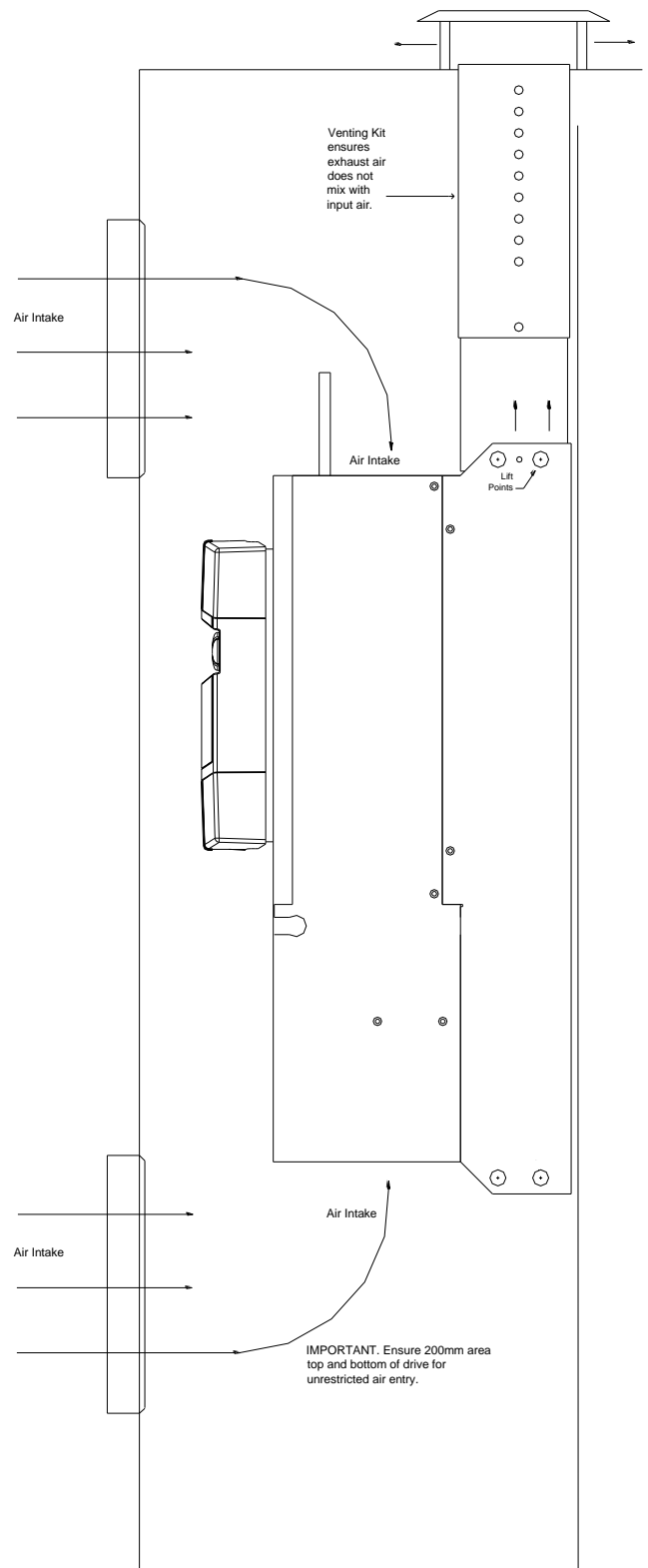

## **10 Product rating labels**

The product rating labels are located on the unit under the upper end cap. The product serial number is unique and can be used by the manufacturer to identify all ratings of the unit. The power ratings and model type are also found here, along with any product standard labels applicable to the unit.

# 11 Semiconductor fusing

**Important note:** All units must be protected by correctly rated semiconductor fuses. Failure to do so will invalidate warranty. For semiconductor fuses please refer to supplier.

## 11.1 L1,2,3 supply fusing total clearing I<sup>2</sup>t ratings

### 11.1.1 Standard 150% overload models

Model	L1,2,3 supply fuses maximum total clearing I <sup>2</sup> t expressed in A <sup>2</sup> s			
	480VAC standard models	480VAC standard models	690VAC HV models	690VAC HV models
	<b>50Hz supply</b>	<b>60Hz supply</b>	<b>50Hz supply</b>	<b>60Hz supply</b>
JL/X130	60000	60000	N/A	N/A
JL/X170	60000	60000	N/A	N/A
JL/X220	128000	128000	N/A	N/A
JL/X270	128000	128000	N/A	N/A
JL/X370	1,170,000	1,170,000	810,000	770,000
JL/X450	1,170,000	1,170,000	810,000	770,000
JL/X530	1,170,000	1,170,000	810,000	770,000
JL/X615	1,170,000	1,170,000	810,000	770,000
JL/X700	1,170,000	1,170,000	810,000	770,000
JL/X780	1,304,000	1,290,000	1,260,000	1,200,000
JL/X860	1,304,000	1,290,000	1,260,000	1,200,000
JL/X1025	3,240,900	3,240,900	2,243,700	2,132,900
JL/X1190	3,240,900	3,240,900	2,243,700	2,132,900
JL/X1350	4,212,000	4,212,000	2,916,000	2,772,000
JL/X1520	4,694,400	4,694,400	2,916,000	2,772,000
JL/X1680	4,694,400	4,694,400	2,916,000	2,772,000

### 11.1.2 HD 250% overload models

Model	L1,2,3 supply fuses maximum total clearing I <sup>2</sup> t expressed in A <sup>2</sup> s			
	480VAC standard models	480VAC standard models	690VAC HV models	690VAC HV models
	<b>50Hz supply</b>	<b>60Hz supply</b>	<b>50Hz supply</b>	<b>60Hz supply</b>
JL/XHD75	60000	60000	N/A	N/A
JL/XHD100	60000	60000	N/A	N/A
JL/XHD130	128000	128000	N/A	N/A
JL/XHD160	128000	128000	N/A	N/A
JL/XHD220	1,170,000	1,170,000	810,000	770,000
JL/XHD270	1,170,000	1,170,000	810,000	770,000
JL/XHD320	1,170,000	1,170,000	810,000	770,000
JL/XHD370	1,170,000	1,170,000	810,000	770,000
JL/XHD420	1,170,000	1,170,000	810,000	770,000
JL/XHD470	1,304,000	1,290,000	1,260,000	1,200,000
JL/XHD520	1,304,000	1,290,000	1,260,000	1,200,000
JL/XHD615	3,240,900	3,240,900	2,243,700	2,132,900
JL/XHD715	3,240,900	3,240,900	2,243,700	2,132,900
JL/XHD815	4,212,000	4,212,000	2,916,000	2,772,000
JL/XHD910	4,694,400	4,694,400	2,916,000	2,772,000
JL/XHD1010	4,694,400	4,694,400	2,916,000	2,772,000

Bardac part numbers for L1,2,3 supply fuses/fuseholders

11.2 | Bardac part numbers for L1,2,3 supply fuses/fuseholders

11.2.1 Standard 150% overload models

Model	Bardac part numbers				
	480VAC standard models	480VAC standard models	690VAC HV models	690VAC HV models	Fuseholder
	<b>50Hz supply</b>	<b>60Hz supply</b>	<b>50Hz supply</b>	<b>60Hz supply</b>	
JL/X130	CH008160	CH008160	N/A	N/A	3 * CP102054
JL/X170	CH009250	CH009250	N/A	N/A	1 * CP102055
JL/X220	CH009250	CH009250	N/A	N/A	1 * CP102055
JL/X270	CH010550	CH010550	N/A	N/A	1 * CP102233
JL/X370	CH010550	CH010550	TBA	TBA	1 * CP102233
JL/X450	CH010700	CH010700	TBA	TBA	1 * CP102233
JL/X530	CH103301	CH103301	CH103331	CH103331	N/A
JL/X615	CH103302	CH103302	CH103332	CH103332	N/A
JL/X700	CH103303	CH103303	CH103333	CH103333	N/A
JL/X780	CH103304	CH103304	CH103334	CH103334	N/A
JL/X860	CH103305	CH103305	CH103335	CH103335	N/A
JL/X1025	CH103306	CH103306	CH103336	CH103336	N/A
JL/X1190	CH103307	CH103307	CH103337	CH103337	N/A
JL/X1350	CH103308	CH103308	CH103338	CH103338	N/A
JL/X1520	CH103309	CH103309	CH103339	CH103339	N/A
JL/X1680	CH103310	CH103310	CH103340	CH103340	N/A

11.2.2 HD 250% overload models

Model	Bardac part numbers				
	480VAC standard models	480VAC standard models	690VAC HV models	690VAC HV models	Fuseholder
	<b>50Hz supply</b>	<b>60Hz supply</b>	<b>50Hz supply</b>	<b>60Hz supply</b>	
JL/XHD75	CH008160	CH008160	N/A	N/A	3 * CP102054
JL/XHD100	CH009250	CH009250	N/A	N/A	1 * CP102055
JL/XHD130	CH009250	CH009250	N/A	N/A	1 * CP102055
JL/XHD160	CH010550	CH010550	N/A	N/A	1 * CP102233
JL/XHD220	CH010550	CH010550	TBA	TBA	1 * CP102233
JL/XHD270	CH010700	CH010700	TBA	TBA	1 * CP102233
JL/XHD320	CH103301	CH103301	CH103331	CH103331	N/A
JL/XHD370	CH103302	CH103302	CH103332	CH103332	N/A
JL/XHD420	CH103303	CH103303	CH103333	CH103333	N/A
JL/XHD470	CH103304	CH103304	CH103334	CH103334	N/A
JL/XHD520	CH103305	CH103305	CH103335	CH103335	N/A
JL/XHD615	CH103306	CH103306	CH103336	CH103336	N/A
JL/XHD715	CH103307	CH103307	CH103337	CH103337	N/A
JL/XHD815	CH103308	CH103308	CH103338	CH103338	N/A
JL/XHD910	CH103309	CH103309	CH103339	CH103339	N/A
JL/XHD1010	CH103310	CH103310	CH103340	CH103340	N/A

## 12 Line reactors

Only use UL certified line reactors for installations complying with UL codes. These line reactors are not certified. Refer to supplier for certified alternatives.

Model	Bardac part number	Bardac part number
	480V AC Supply	690V AC Supply
JL/X130 or JL/XHD75	LR270	N/A
JL/X170 or JL/XHD100	LR270	N/A
JL/X220 or JL/XHD130	LR270	N/A
JL/X270 or JL/XHD160	LR330	N/A
JL/X370 or JL/XHD220	LR530	LR530HV
JL/X450 or JL/XHD270	LR650	LR650HV
JL/X530 or JL/XHD320	LR650	LR650HV
JL/X615 or JL/XHD370	LR650	LR650HV
JL/X700 or JL/XHD420	LR950	LR950HV
JL/X780 or JL/XHD470	LR1050	LR1050HV
JL/X860 or JL/XHD520	LR1050	LR1050HV
JL/X1025 or JL/XHD615	LR1250	LR1250HV
JL/X1190 or JL/XHD715	LR1650	LR1650HV
JL/X1350 or JL/XHD815	LR1650	LR1650HV
JL/X1520 or JL/XHD910	LR2050	LR2050HV
JL/X1680 or JL/XHD1010	LR2050	LR2050HV

Refer to supplier for line reactor dimensions.

## 13 Installation

### 13.1 Lifting the frame 4 and 5 units

Use the lifting points provided. There are lifting holes at each end of the unit. Attach a loop of suitable rope (approx. 1.2m for JL/X370-780 and 1.5m for JL/X860-1680) between the lifting holes at each side at the top end, and a similar loop at the bottom end, to assist in lifting the unit out of its container. When lifting the unit keep it in either the horizontal or vertical plane to avoid deforming the side cheeks at the lifting points. Use the top end lifting loop to assist in presenting the unit onto the back panel. The fixing holes at the top of the unit are designed with a keyhole shape to allow the unit to be initially hung on the securing bolts. These should be fixed on the back panel prior to presenting the unit into the enclosure.

Alternatively a small fork lift may be employed if the wheel has access under the door of the enclosure. (It is usually possible to have access for one fork from the side of a typical enclosure with the side panel removed). If access can be gained this way then you will need to bolt some temporary wooden extensions to the lifting holes at the bottom of the unit in order to stand the unit on the fork which will enter the enclosure).

### 13.2 Terminal tightening torques

Terminals	Model	Tightening torque
1 to 53	All models	4 lb-in or 0.5 N-m
EL1 EL2 EL3	JL/X130 - 270 & JL/XHD75 - 160	9 lb-in or 1.0 N-m
EL1 EL2 EL3	JL/X370 - 1680 & JL/XHD220 - 1010	35 lb-in or 3.9 N-m
L1 L2 L3 U V W	All models	242 lb-in or 27 N-m
B1 B2	JL/X370 - 1680 & JL/XHD220 - 1010	9 lb-in or 1.0 N-m

### 13.3 Forces applied to the power terminals

Avoid applying mechanical stress to the heavy current terminals L1/L2/L3/U/V/W. Please ensure that any cables or busbars that are bolted to these terminals are supported within the enclosure. Do not rely on the JL/X terminals to support the weight of the external connections.

Do not use the connecting bolt to hold the terminal and the connecting cable or busbar in alignment. If they have been forced into alignment prior to inserting the bolt then there will be a permanent stress on the terminal. Always support the connection to the terminal such that the only purpose of the terminal bolt is to tighten them together and not to maintain their relative position to each other. This ensures minimum stress on the JL/X busbars.

Ensure that the busbars are not subjected to a turning moment as the nuts are torqued down. It is suggested that two spanners are used, one on the bolt head to provide a counter torque and one on the nut to provide tightening torque.

**Important note:** If the unit is in the horizontal plane then there is a danger that objects may be accidentally dropped into the air intake grille when connecting the busbars to the terminals. Or when the unit is vertical, dropping washers into the fin section at the top, or objects dropping through the upper air intake grill. As a precaution it is advised that a temporary cover be utilised over these areas when working on the unit. Ensure the temporary cover is removed prior to starting the unit. If anything is dropped into the unit then it may interfere with the fan rotation.

### 13.4 Installation guide for EMC

Special consideration must be given to installations in member states of the European Union regarding noise suppression and immunity. According to IEC 1800-3 (EN61800-3) the drive units are classified as Basic Drive Modules (BDM) only for professional assemblers and for the industrial environment. Although CE Marking is made against the EMC Directive, application of EN 61800-3 means that no RF emission limits apply. The drive manufacturer is responsible for the provision of installation guidelines. The resulting EMC behaviour is the responsibility of the manufacturer of the system or installation. The units are also subject to the LOW VOLTAGE DIRECTIVE 73/23/EEC and are CE marked accordingly.

Following the procedures outlined will normally be required for the drive system to comply with European regulations, some systems may require different measures.

Installers must have a level of technical competence to correctly install. Although the drive unit itself does not require control of RF emissions, it has been designed and tested to comply with the most stringent emissions and immunity requirements on all ports.

EN61800-3 specifies 2 alternative operating environments. These are the domestic (1<sup>st</sup> environment) and industrial (2<sup>nd</sup> environment). The definition of 2<sup>nd</sup> environment is all establishments other than those directly connected to a low voltage power supply network which supplies buildings used for domestic purposes. There are no limits specified for conducted or radiated emissions in the industrial environment, hence it is usual for the filter to be omitted in industrial systems.

A separate filter is required for those installations operating within the 1<sup>st</sup> environment. Please refer to supplier for a suitable filter to meet the Class A (EN 61800-3 restricted distribution, domestic environment) if necessary.

### 13.5 Guidelines for earthing and screening

A separate earth conductor should be taken from the motor housing and run adjacent to the drive conductors to the main earth terminal on the drive. This conductor should not be grounded separately to any other earth point. The drive earth terminal should be separately taken to the cabinet star earth point, as should the 0V connection reference at Terminal 13 and any individual signal cable screens.

Motor and three-phase supply cables should be segregated from other cables in the cabinet, preferably by a distance of at least 300mm. Where crossing of these cables with signal cables is unavoidable, they should do so at right angles.

Motor cables can be screened or armoured, especially if they pass near other sensitive apparatus, and the screening should be bonded to the motor housing and the point of entry of the cabinet using 360° gland techniques.



It is understood that the bonding of both ends of the screening and earth conductors may result in significant earth current flow if the motors and control cabinet are in widely different locations, so that there are large earth potential differences. In these circumstances it is recommended that a separate preferential earth conductor (PE) – for example a bonded metal conduit - is used alongside the drive cables to give a preferential route for this current. See IEC 61000-5-2 for more detail. Installation in conformance with this standard is regarded as good practice and will result in improved EMC of the whole system.

**Important note:** Safety earthing always takes precedence over EMC earthing.

### 13.6 Guidelines when using supply filters

IMPORTANT SAFETY WARNINGS			
	The AC supply filters must not be used on supplies that are un-balanced or float with respect to earth	The drive and AC filter must only be used with a permanent earth connection. No plugs/sockets are allowed in the AC supply	The AC supply filter contains high voltage capacitors and should not be touched for a period of 20 seconds after the removal of the AC supply

The AC connections from the filter to the drive should be as short as possible, and correctly screened if longer than 300mm.

Any separate AC filter earth connection should connect directly to the cabinet star earth point.

Do not run filtered and unfiltered AC supply cables together.

An AC input filter has earth leakage currents, any supply RCD devices may need to be set >5% of rated current.

The AC filter chassis must have a good earth connection to the enclosure back plane. Take care with painted metal. Remove paint and ensure good connection.

# 14 JL/X block diagrams

## 14.1 Normal page default block diagrams

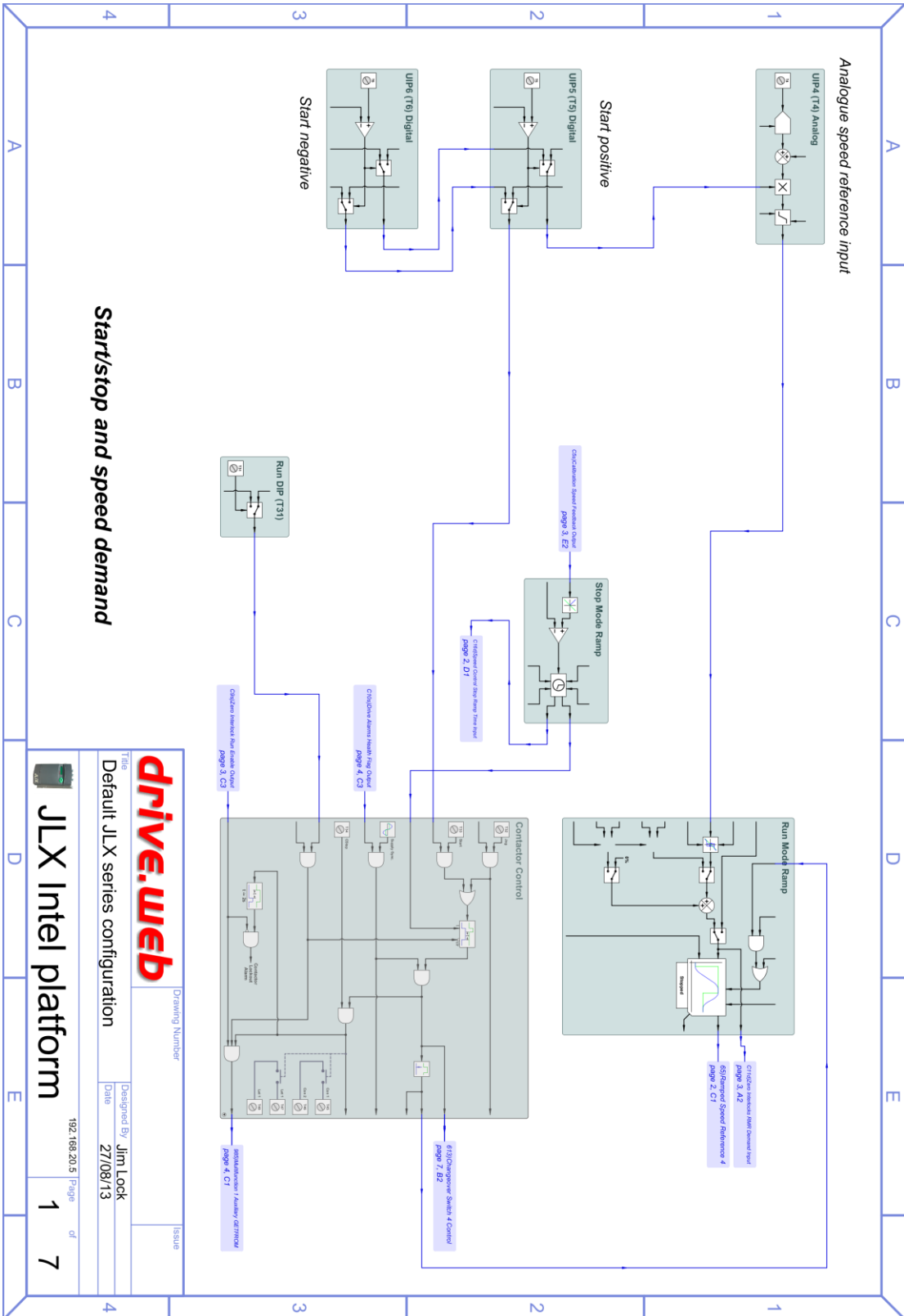

### Start/stop and speed demand

**drive.web**  
 Title: Default JLX series configuration  
 Drawing Number: \_\_\_\_\_  
 Issue: \_\_\_\_\_  
 Designed By: Jim Lock  
 Date: 27/08/13  
 192.168.20.5 Page 1 of 7

JLX Intel platform

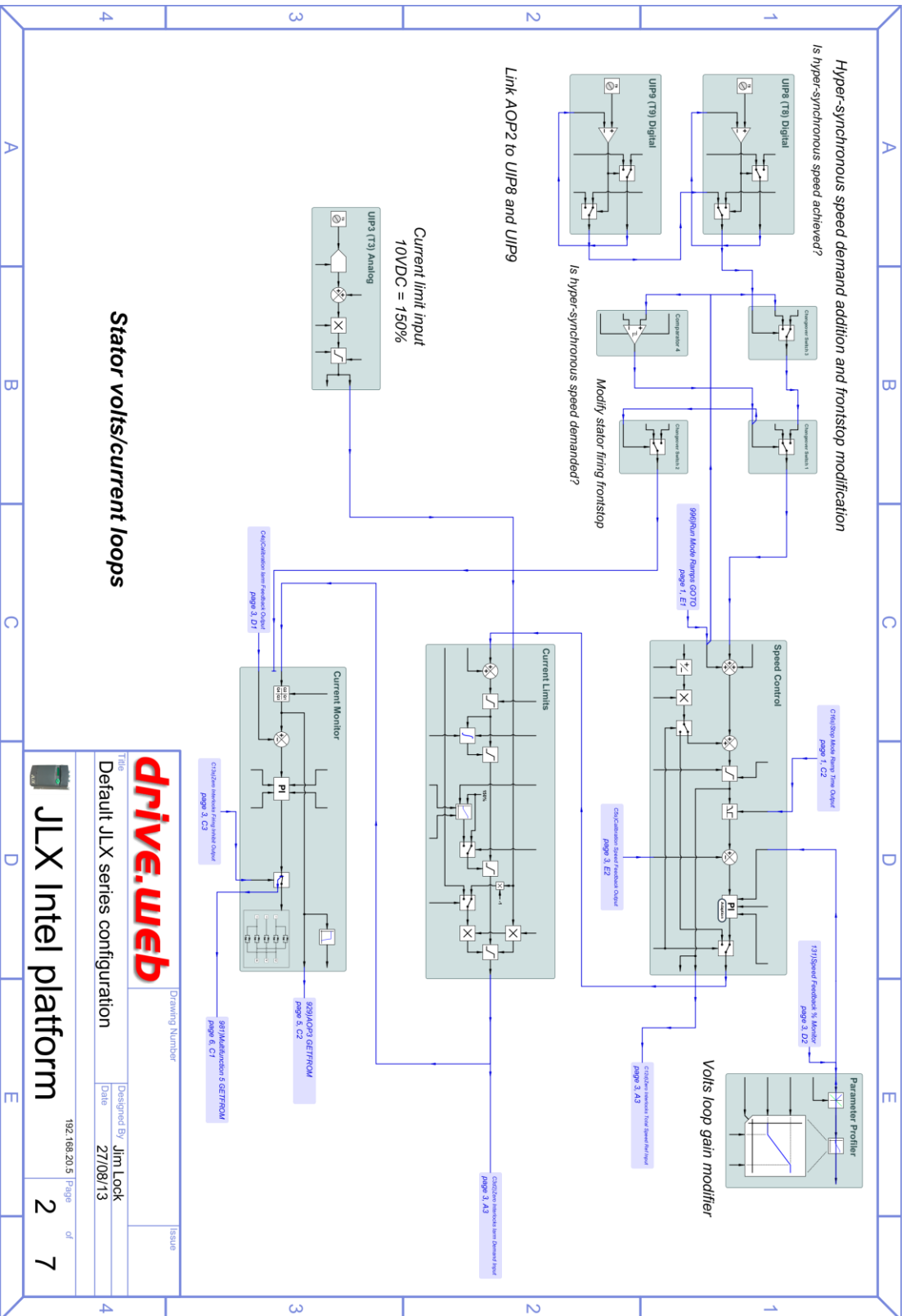

**Stator volts/current loops**

**drive.web** Drawing Number

The Default JLX series configuration

Designed By Jim Lock

Date 27/08/13

192.168.20.5 Page 2 of 7

**JLX Intel platform**

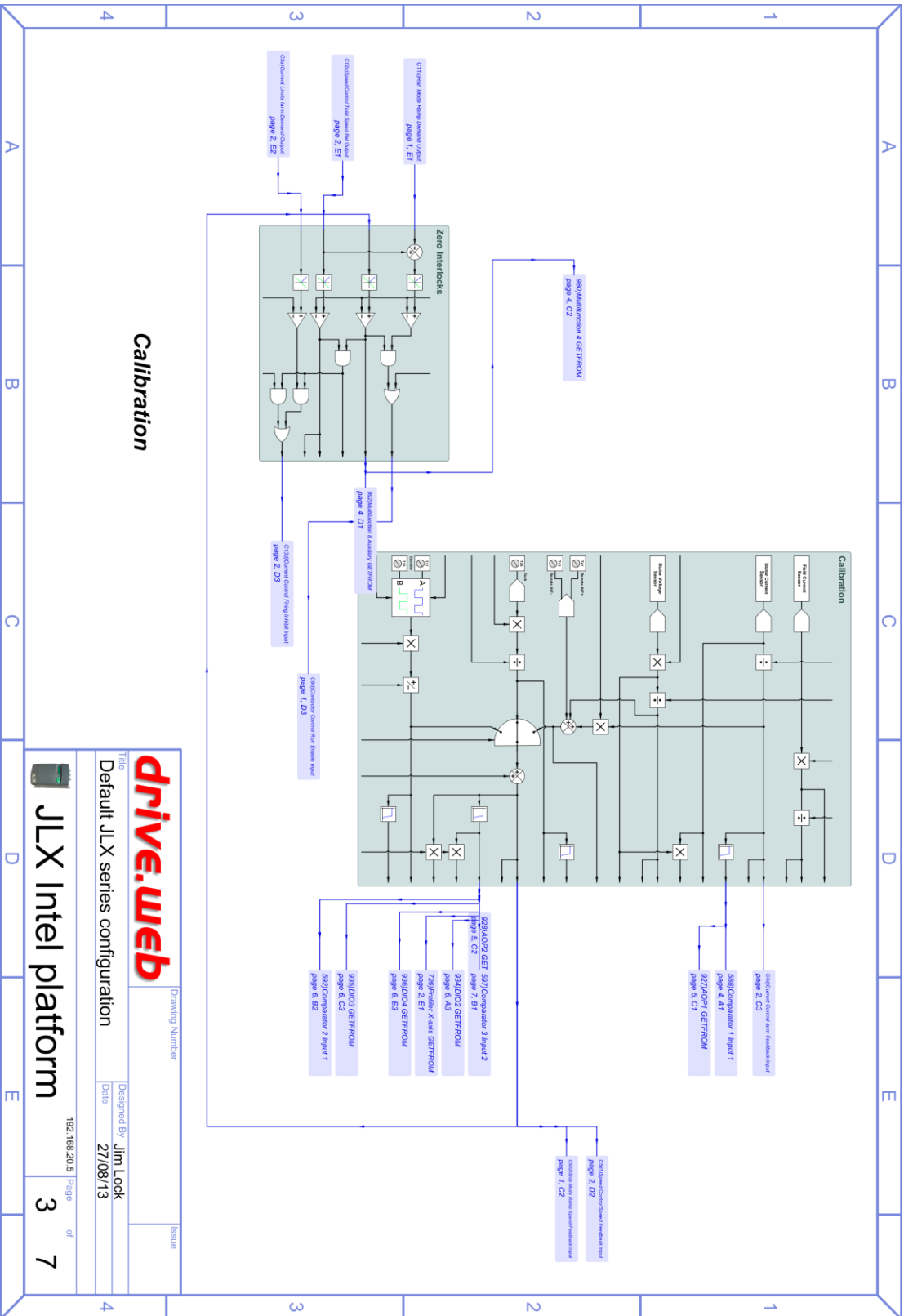

**Calibration**

**drive.web**

Title: Default JLX series configuration

Designed By: Jim Look

Date: 27/08/13

192.168.20.5 Page 3 of 7

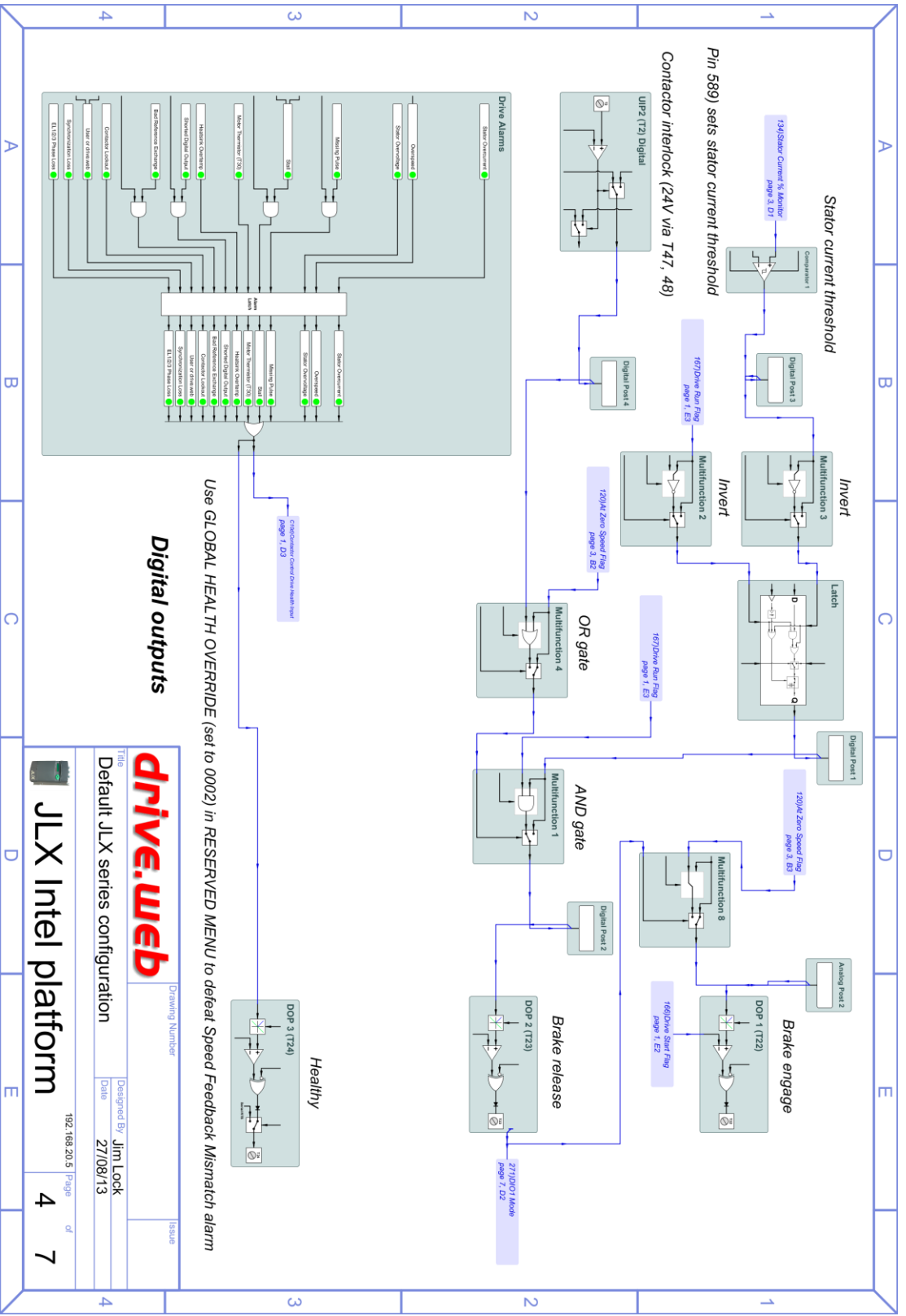

Use GLOBAL HEALTH OVERRIDE (set to 0002) in RESERVED MENU to defeat Speed Feedback Mismatch alarm

**Digital outputs**

**drive.web**  
 Drawing Number Issue

FILE  
 Default JLX series configuration  
 Designed By Jim Lock  
 Date 27/08/13

192.168.20.5 Page 4 of 7

**JLX Intel platform**

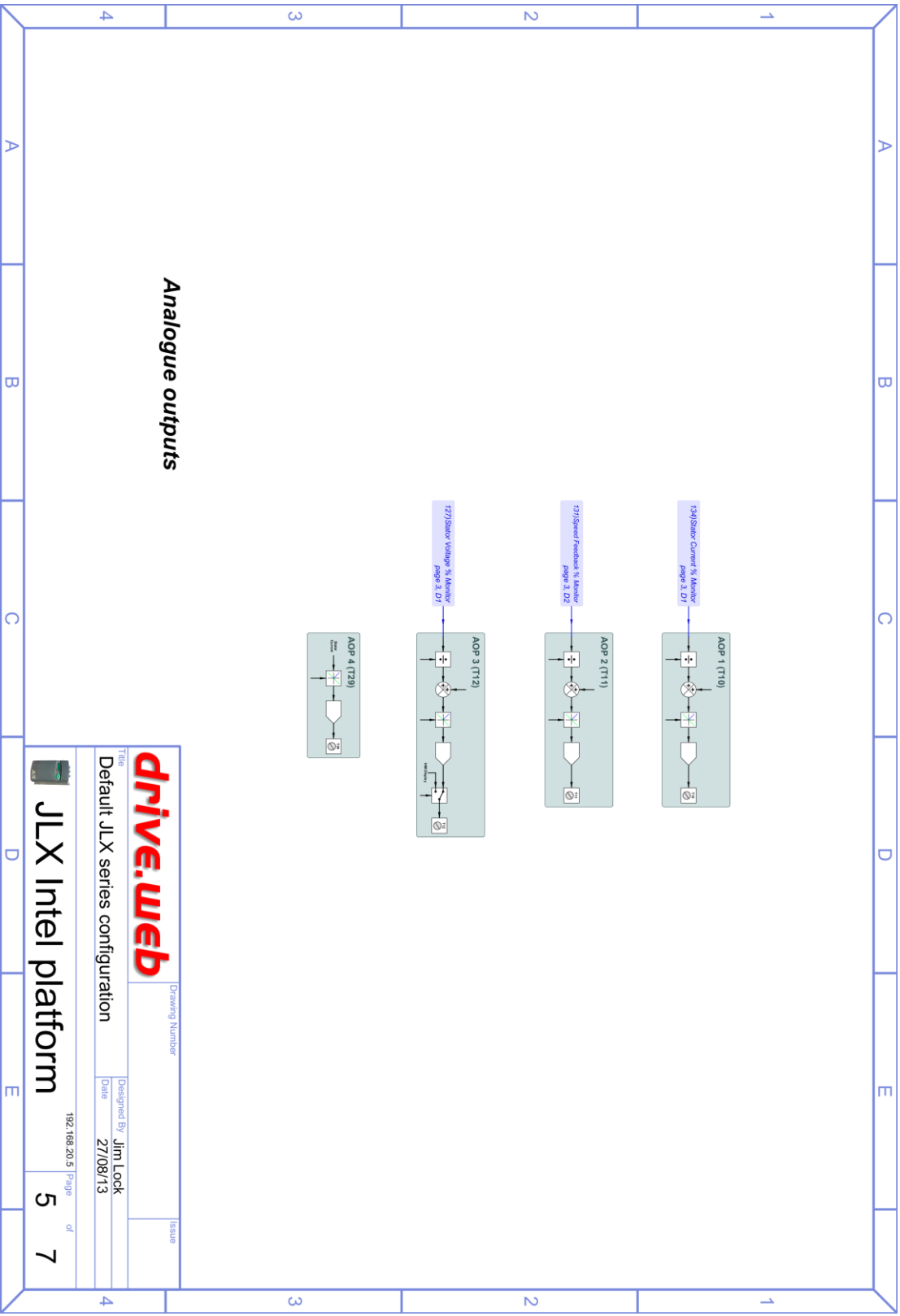

**Analogue outputs**

<b>drive.web</b>		Drawing Number		Issue	
Title		Designed By		Date	
Default JLX series configuration		Jim Look		27/08/13	
192.168.20.5		Page		of	
JLX Intel platform		5		7	

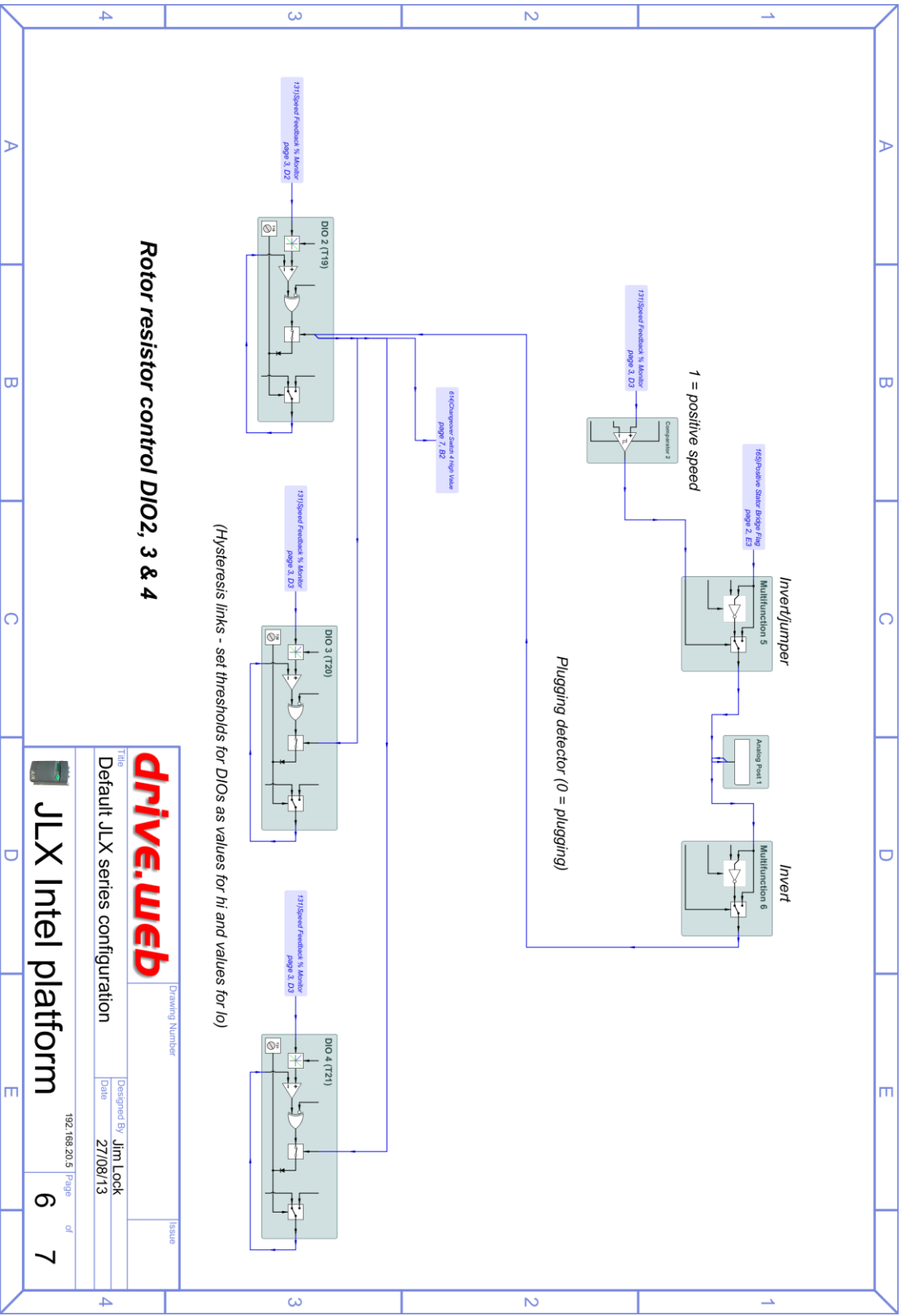

**Rotor resistor control DIO2, 3 & 4**

(Hysteresis links - set thresholds for DIOs as values for hi and values for lo)

<b>drive.web</b>		Drawing Number		Issue	
Default JLX series configuration		Designed By Jim Lock		Date 27/08/13	
JLX Intel platform		192.168.20.5		Page 6 of 7	

*DIO1 on for speed below threshold*  
*Pin 596) sets DIO1 detection threshold*  
*Pin 599) sets detection hysteresis*

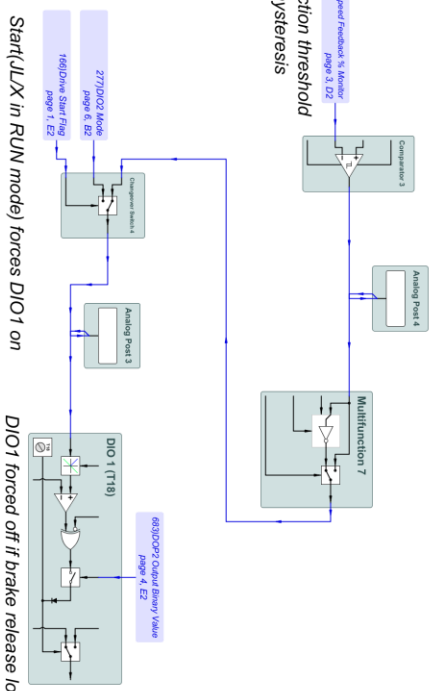

### Rotor resistor control DIO1

<b>drive.web</b>		Drawing Number	Issue
Title		Designed By	
Default JLX series configuration		Jim Look	
		Date	
		27/08/13	
		192.168.20.5	Page
			7 of 7

JLX Intel platform



14.2 3-key reset page default block diagrams

**Not yet implemented – drawings to follow**

## 15 Record of manual modifications

Date	Manual version	JL/X software version	Notes
October 2013	1.0	1.23	Initial issue of full manual

