



Bardac drives

basicPL/X Quick Start

This Quick Start is a supplement to the standard product manuals intended for use as a guide to get your PL/X Drive up and running as

a basic speed controller in a safe and efficient manner. For all other applications, refer to the PL/X Product and Applications Manuals.



Only qualified personnel who thoroughly understand the operation of the machine on which the PL/X is installed and who are familiar with electrical wiring and safety standards should attempt to commission this equipment.

With ALL Power OFF

A. Connect up the drive

Hook your drive up according to the following diagrams. Ensure power and control wiring are routed in separate conduit/cable trays and wiring meets applicable national and local electrical codes.

Power Wiring Diagram

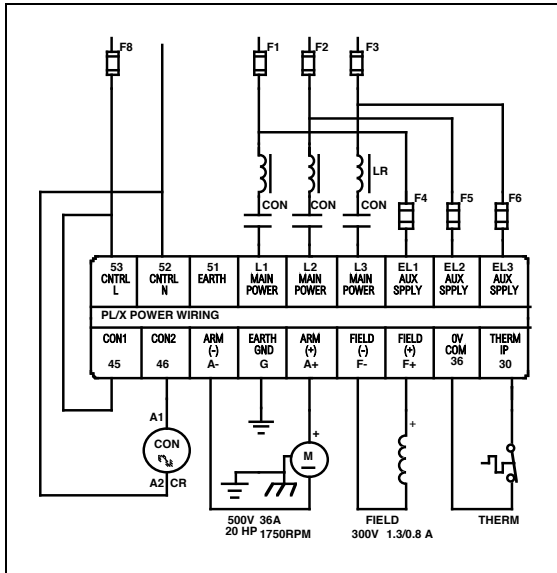

See Product Manual for fuse specifications.

Power Terminals

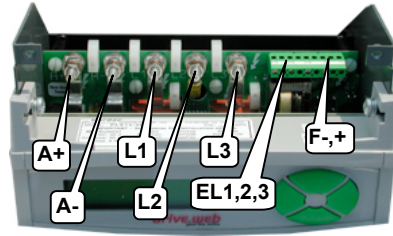

Control Wiring Diagram

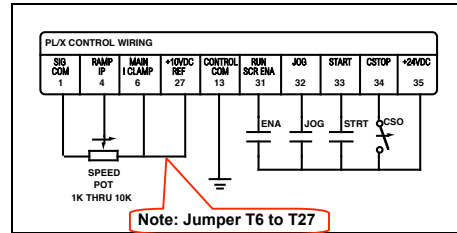

Control Terminals

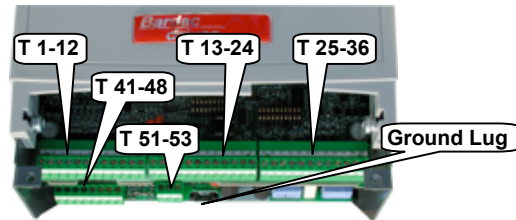

Contact Descriptions (All are maintained-type)

CSO (Coast Stop Override): Must be closed prior to all other control signals for proper sequencing. When opened, the drive immediately stops generating armature current and the contactor drops out. Motor coasts to stop.

ENA (Enable): Electronic inhibit for all modes of operation. When closed, the drive may generate current. If open, no armature current will be generated. May be jumpered to Terminal 35 in most applications.

JOG: When closed, the drive's contactor comes in and the motor will run at the Jog Speed 1 setting (Default 5% speed). When opened, the drive ramps to zero and contactor opens after a delay (Default = 2 secs).

STRT (Start): When closed, the drive's contactor comes in and the motor will run at potentiometer speed setting. When opened, the drive ramps to zero and contactor opens after a delay (Default = 2 secs).

As programmed from the factory, after removal of the control input, the motor field current will be present until the field quench delay is completed (Default = 10 secs).

Optional Feedback Devices

DC Tachometer

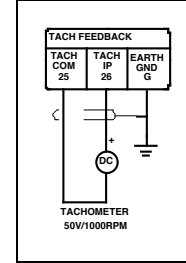

Encoder

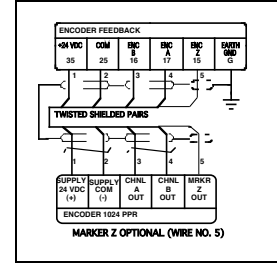

A. Get the supply and motor nameplate data

Description	Typical	Actual	Units
Supply Voltage (VL)	480		VAC
Armature Volts (VA)	500		VDC
Armature Current (IA)	35		ADC
Base Speed (BS)	1750		RPM
Maximum Speed (MS)	2300		RPM
Field Volts (VF)	300		VDC
Field Current @ BS (IFb)	1.35		ADC
Field Current @ MS (IFm)	0.8		ADC
Feedback Device			
DC Tachometer (TV)	50		V/1000
Encoder (PPR)	1024		PPR
Supply Volts (EV)	5 - 24		VDC

Navigating through the menus



The green keys are used to setup the drive. In this Quick Start, the required key sequences are displayed to the left of each parameter to be modified. When executed correctly, the display on the drive should match the one shown.

Legend of abbreviations used for keystrokes:

L,R,U,D = Press the specified button **EXACTLY** once.

8xU = Press the **Up** button 8 times.

U/D = Use the **Up** button to increase the value, use the **Down** button to decrease the value.

Final Power OFF Checks

Recheck all your wiring, especially the drive's chassis ground. Also, use your multimeter to check the **L1, L2, L3, F+, F-, A+,** and **A-** Terminals for short circuits to ground. All readings should be greater than 1 MΩ. Correct any low resistances prior to applying power.

It is essential to perform all of the following steps in their entirety and in the proper sequence! If in doubt, call 1-888-667-7333 (International 410-604-3400).

Power ON Checks

1. Apply Control Power and Calibrate

Apply 100-240 VAC control power to T53 (Line) and T52 (Neutral).

2. Calibrate the Drive to the Motor

At power up, the Diagnostic Summary Screens are displayed. By pressing the Left key at least 5 times, you will return you to these screens from any menu level.

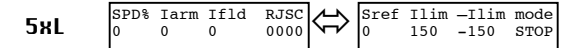

When at the top level, the display toggles between the Diagnostic Summaries about every 5 seconds.

Press the keys in the sequence below to set the rated armature current from the nameplate data you recorded.

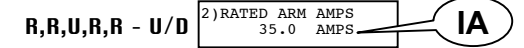

Use the up and down keys to change the values.

Now, to move to the rated field current:

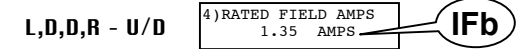

Repeat these steps for the following:

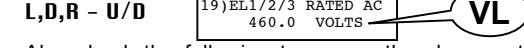
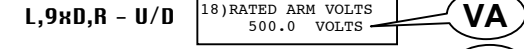
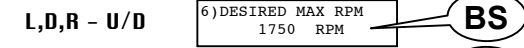
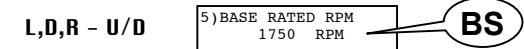

Also check the following to ensure they have not been modified from the factory default settings:

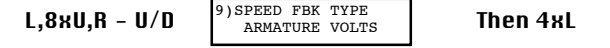
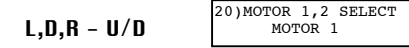

Then 4xL

Although the drive regulates field current by default, set the field voltage clamp as a percentage of AC supply volts.

$$FV \% = (FV \div VL) \times 100$$

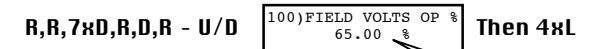

Feedback calibration

If you do not have a DC tachometer or encoder, skip this section and go to **Step 3**.

DC Tachometer Calibration

For a tachometer, initially calibrate the drive for the expected DC voltage at base speed.

$$TVb = (BS \div 1000) \times TV$$



Caution:

TVb must not exceed 200 VDC.

R,R,U,R,6xD,R - U/D

8)ANALOG TACHO VOLTS
87.50 VOLTS

Then 4xL

TVb

Encoder Calibration

Ensure quadrature is enabled and enter the PPR.

R,R,U,R,8xD,R,R - U/D

10)QUADRATURE ENABLE
ENABLED

L,D,R - U/D

11)ENCODER LINES
1024

Then 4xL

PPR

3. Save Parameters

To save your work thus far, from the Diagnostic Screens:

R,U,R

PARAMETER SAVE
UP KEY TO CONTINUE 2

U

PARAMETER SAVE
SAVING 2

When done

PARAMETER SAVE
FINISHED 2

Then 2xL

4. Check Control Terminals

The next few checks are to ensure the drive contactor is sequenced properly prior to applying three phase power. The value under the letters **TRJSC** in the display indicate the actual Control Input (**CIP**) terminal status.

Letter	Terminal	Contact
Thermistor	30	THERM
Run	31	ENA
Jog	32	JOG
Start	33	STRT
Coast Stop	34	CSO

From the Diagnostic Screens, go to the CIP Diagnostic.

R,D,R,4xD,R,D,D,R

164)DOP 123TRJSC CIP
10100000

Leaving the **CSO** contact of your control wiring open (a **0** under the **C**), close the other control contacts. Check to see if the digit under the appropriate letter changes as you cycle of the contact. Generally, **1 = ON** while **0 = OFF** (for the thermistor T, **0 = OK** while **1 = Motor Overtemp**).

Once satisfied with the operation of the **T,R,J**, and **S** control inputs, leave **R,J**, and **S OFF** and check the **C** control input for proper operation.

5. Apply Main Three Phase Power

6. Autotune the PL/X

Prior to running the motor, the current loop of the drive must be tuned to the motor and cabling (**PIN**'s 93,94,& 95).

a) Ensure the drive is in a normal stop condition. The CIP's should match **TRJSC** below:

Still from Step 4

164)DOP 123TRJSC CIP
10101001

Then 4xL

b) Enable the autotune mode.

R,R,6xD,R,7xD,R - U

92)AUTOTUNE ENABLE
ENABLED

Then 4xL

c) Start the drive by energizing the Start Input (T33).

R,D,R,4xD,R,D,D,R

164)DOP 123TRJSC CIP
10101011

Then 4xL

The contactor will close and an autotune will be performed (takes 10 - 60 seconds). When complete, the drive's contactor will open. Turn off the Start Input (T33).

Now, **SAVE PARAMETERS** as described in **Step 3**.

7. Motor Rotational Checks

Ideally, you would like to perform these running checks with the motor disconnected from the gear box and the machine.

As an additional precaution, restrict the available current to the drive by reducing the Current Limit to just enough current to turn the motor (usually 5 to 10%).

R,R,U,R,D,R - D

3)CURRENT LIMIT (%)
5.00 %

Check operation of the speed potentiometer by monitoring the Ramp Input. Leave the reference at zero after checking for proper operation.

L,L,D,R,5xD,R

26)RAMP INPUT
75.14 %

Then 4xL

Start the drive by energizing the Start Input (T33). Check the field voltage at the **F+** and **F-**. When the motor is cold, you will measure somewhat less than the rated field voltage (approximately 240 VDC for a 300 VDC rated field).

Confirm the field current matches the **IFb** nameplate data.

R,D,R,D,R,D,D,R

145)FLD CUR AMPS MON
1.35 AMPS

Then 4xL

Increase the potentiometer setting until the motor is turning slowly. Check motor rotation. If backwards, stop, turn off **ALL** power to the drive, and swap the field leads (**F+**, **F-**). Recheck after changes.

Now, slowly bring the motor up to full speed while checking the voltage on the **A+** and **A-** terminals.

R,D,R,R,3xD,R

126)ARM VOLTS MON
500.0 VOLTS

If you have neither a tachometer nor encoder, skip to **Step 9**. If using a tachometer or encoder, check to ensure the speed reference is positive (+).

3xU

123)TOTAL SPD REF MN
26.50 %

Then, check the sign of the feedback, as follows:

Tachometer Feedback

6xD

129)TACHO VOLTS MON
-23.19 VOLTS

Then 4xL

If positive (+), skip to **Step 8**. If negative (-), stop, power off the drive, then swap the tachometer leads on T25 and T26 and recheck.

Encoder Feedback

2xU

132)ENCODER RPM MON
-464 RPM

Then 4xL

If positive (+), skip to **Step 8**. If negative (-), stop the drive and invert the encoder sign and recheck.

R,R,U,R,8xD,R,3xD,R - D

13)ENCODER SIGN
INVERT

5xL

8. Switching Feedback Type

Now, stop the drive and select the appropriate feedback.

Tachometer Feedback

R,R,U,R,7xD,R - U

9)SPEED FBK TYPE
ANALOG TACHO

Then 4xL

Encoder Feedback

R,R,U,R,7xD,R - 2xU

9)SPEED FBK TYPE
ENCODER

Then 4xL

Again, start the drive and ensure maximum speed can be obtained and the armature voltage does not exceed the nameplate **VA**.

9. Increase the Current Limit to Rated Value

At this point, the Current Limit may be returned to 150%.

R,R,U,R,D,R - U

3)CURRENT LIMIT (%)
150.00 %

Then 4xL

Now, **SAVE PARAMETERS** as described in **Step 3**.

10. Adjusting the Speed Calibration at Base Speed

Gradually, increase your potentiometer to the maximum position and then adjust the final speed of the motor.

Depending on the final feedback type, different parameters (**PIN**'s 16, 17,& 6) are used for speed calibration.

Do **NOT** exceed the base speed (**BS**) value while adjusting these parameters. These calibration parameters may be adjusted while the drive is running.

Armature Voltage

R,R,U,R,5xU,R - U

16)ARM VOLTS TRIM
1.0000

Then 4xL

Increase this value to reduce the armature voltage. If this parameter does not provide enough adjustment, stop and readjust **PIN 18 - Rated Arm Volts** from **Step 2**.

Tachometer Feedback

R,R,U,R,4xU,R - U

17)ANALOG TACHO TRIM
1.0000

Then 4xL

Increase this value to reduce the motor speed. If this parameter does not provide enough adjustment, stop and readjust **PIN 8 - Analog Tacho Volts** from **Step 2**.

Encoder Feedback

R,R,U,R,4xD,R - U/D

6)DESIRED MAX RPM
1750 RPM

Then 4xL

Change this value to achieve the desired motor speed.

Again, **SAVE PARAMETERS**.

11. Setting Up Field Weakening

When using either tachometer or encoder feedback, field weakening may be enabled for a motor which supports an extended speed range.

a) First, stop the drive and enable the field weakening mode.

R,R,7xD,R,4xD,R,R - U

103)FLD WEAK ENABLE
ENABLED

b) Next, set the minimum field expected (with a 10% safety margin).

Min Field % = (Ifm ÷ Ifb) x 90

L,7xD,R - U/D

110)MIN FLD CURRENT
53.33 %

Then 4xL

Finally, adjust the maximum speed as described in **Step 10**. Again, do **NOT** exceed the maximum speed (**MS**) value noted on the motor nameplate.

Again, **SAVE PARAMETERS** as described in **Step 3**.

Congratulations, you have successfully commissioned your Bardac PL/X Digital DC Drive.

If you have any questions or do not understand a portion of this Quick Start Manual, please contact us:

Bardac Corporation

40 Log Canoe Circle
Stevensville MD 21666 USA
Phone: 888-ON-SPEED (888-667-7333)
International: 410-604-3400
FAX: 410-604-3500
Website: www.bardac.com
Email: info@bardac.com