

Bardac Drives Catalog 2025

ISSUE 1



drive.web AUTOMATION



AC DRIVES



DC DRIVES

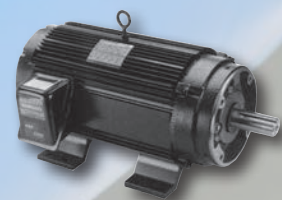

MOTORS

AutomationThings

Everything is...

- ... Internet accessible
- ... Ethernet workable, peer-to-peer
- ... Configurable from anywhere
- ... IIoT ready

AutomationThings.com

Everything normally in stock!



SERVICE

Since our founding in 1992 we have worked hard to build our reputation around key goals:

- Innovative technologies.
- Reliable products.
- Unrelenting customer support.
- All catalog items normally in stock.
- Competitive pricing.



Our Company President: Paul Crowhurst

Bardac ...the safe bet!

Seamlessly Integrated Automation



AC DRIVES

Vector Systems

To 400 HP - pages 36 - 38

ECO fan & pump

To 400 HP - pages 39 - 41

General Purpose

To 50 HP - pages 42 - 43

NEMA 4X (IP66)

To 30 HP - page 44

Single Phase

To 1.5 HP - page 46 - 47

CONTROLLERS

drive.web

Ethernet Distributed Control
pages 3 - 33

smarty

Universal Automation Controllers
with I/O - pages 14 - 22

speedy

Embedded & onboard Controllers
pages 23 - 24

Motion

smart motion controllers
pages 30 - 31

Temperature

smart temperature controller
page 18

TOOLS

savvy

Drive & controller configuration
pages 8 - 9

savvy-SFD

Signal Flow Diagram tools for
system design
pages 10 - 11

drive.web Apps

Pre-Engineered Apps
pages 26 - 33

device Apps

Pre-Engineered interfaces for
third party drives - pages 26 - 33

HMI

savvyPanel

For industrial PC touch screens
pages 12 - 13

savvyPanel mobile

HMI app for iPhone, iPad, Android
page 12

savvyPanel touch

Hi Res industrial touch screens
page 13

DC DRIVES

Single Phase

To 10 HP - pages 48 - 50

DC Servo

Up to 12 A, 48VDC - page 51

3-Phase Digital

To 2000+ HP - pages 52 - 57

Stack Controller

6 & 12 pulse - page 56

Packaged Drives

Modulus pre-engineered
page 58

POWER QUALITY ~ MOTORS ~ ENGINEERING ~ SERVICE ~ SUPPORT ~ TRAINING

drive.web smart technology ... Designed and built in the USA to International Standards: UL, cUL, CE, FCC, UK CA

Specifications ... At the time of going to press we believe the information in this catalog to be accurate. However, the specifications of products may be amended at any time, so please check with us when ordering to ensure that such changes will not affect your requirements.

drive.web

SMART AUTOMATION

Configure, connect & control everything ... in one environment
Internet accessible, peer-to-peer Ethernet with savvy tools
Cost effective for systems of any size or complexity

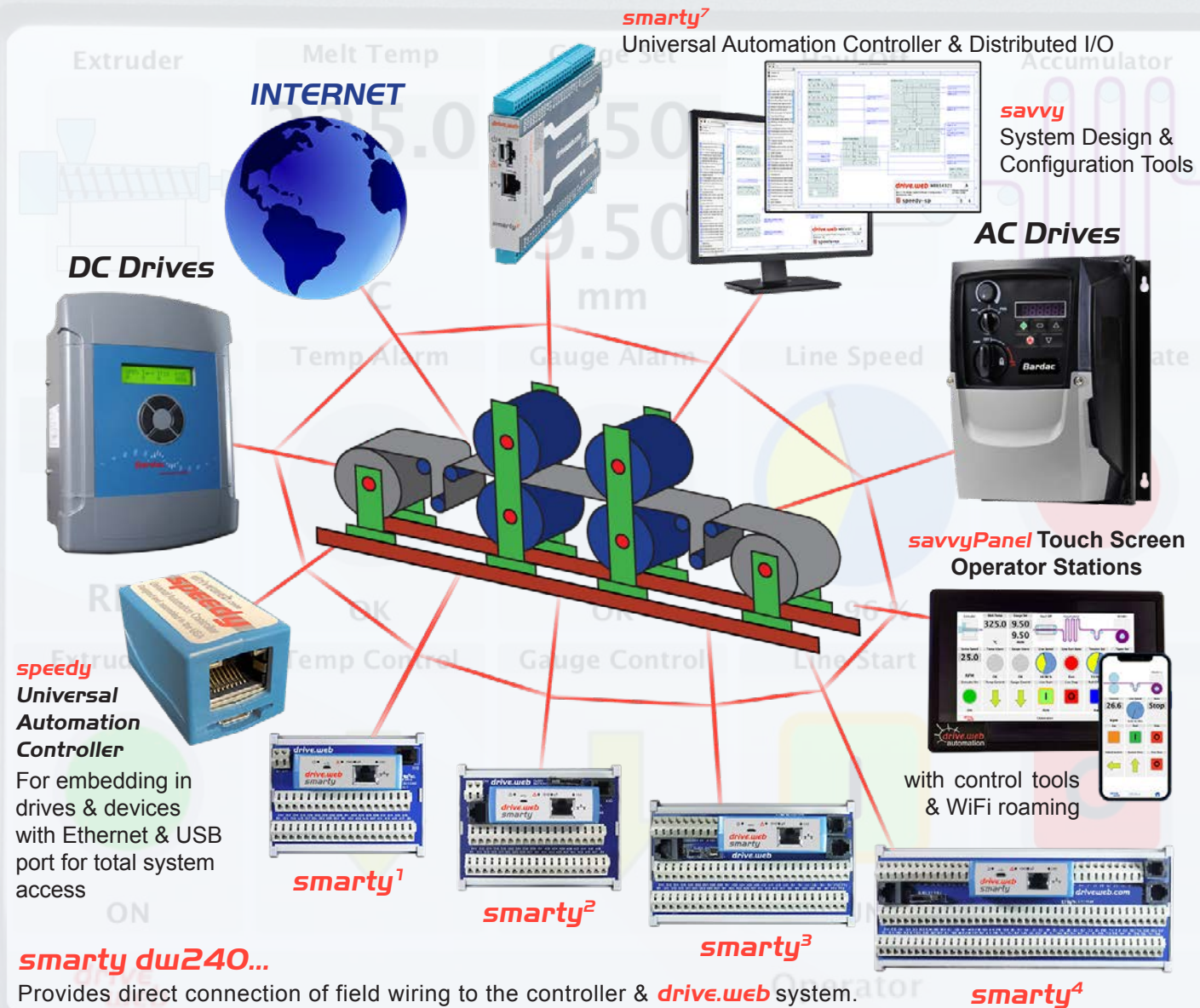

Automation Things ... smart ... connected ... IIoT ready

drive.web smart technology ... Designed and built in the USA to International Standards: UL, cUL, CE, FCC, UK CA

drive.web automation

total connectivity

enterprise management - machine operators - system engineering

drive.web

A Unique Architecture

1 *drive.web* devices connect peer-to-peer over ethernet to form a completely homogenous control environment.

2 *drive.web* devices provide a full featured programmable control environment. Each device processor contributes to the total system processing capacity so that as the system gets bigger it's capacity increases.

3 An unlimited number of *drive.web* devices can be incorporated into a system to provide an unlimited amount of processing capacity and I/O with undiminished performance.

4 The *drive.web* devices store all the device and complete system configuration data including touch screen PC, iOS & Android display data - everything!

5 A *speedy* embedded in a drive takes over the entire drive; its setup, control, & memory management. It becomes an integral part of the drive and now looks just like the drive. Any actions from the drive keypad or terminals or serial ports are instantly synchronized.

6 *savvyPanel* touch screen PC, iOS & Android display graphics and configuration data all resides in the *drive.web* devices so that you can roam to any WiFi location with your iPad and view a system (subject to access permission).

7 Easily create a graphical interface to almost any control device to bring it into your unique, homogenous, *drive.web* environment.

Vector Drives
Easy setup & full featured, programmable control onboard drives

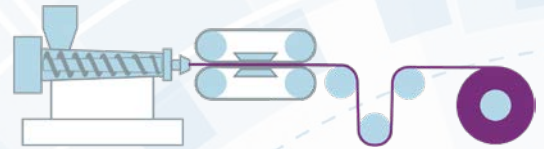

USB Port

- Easy drive configuration
- Plug & play drive interface
- System wide programming access

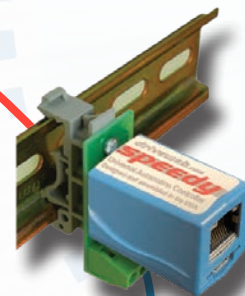

drive.web smart technology designed and built in the USA to International Standards: UL, cUL, CE, FCC, UK CA



savvy

Graphical, function block tools

1. Easy drive configuration
2. Powerful systems design & integration
3. Trend charts
4. Signal flow diagrams
5. Internet access
6. Intuitive system navigation tools

Internet Remote system access

smart automation

production control - maintenance - tech support

speedy

Universal Automation Controllers

- Embedded available
- Easy gateway to instrumentation
- Fast data collection
- Mount anywhere DIN option



DC Regen Drives

save time



High efficiency
ECO drives

speedy

Integrated Universal Automation Controller

- provides easy coordination of ECO drives in building energy systems
- easily interfaces to existing third party drives & controls
- add ethernet and USB device access
- boost network performance
- add full featured programmable control



save energy



savvyPanel touch Hi-res industrial stations

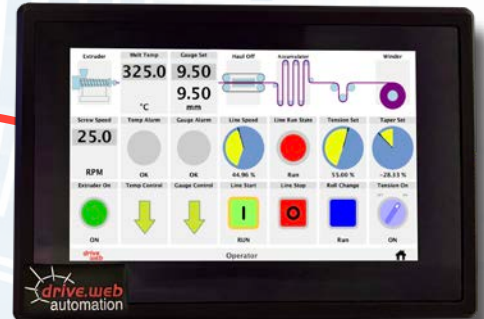

NEW! smarty⁷



smarty

Universal Automation Controllers

- Easy sensor interface
- Precision analog I/O
- Fast logic I/O with powerful state machine programming
- 16 precision analog & logic I/O
- Encoder I/O for indexing, registration, and shaft lock
- Multiple communications options
- Unlimited expansion with no loss of system bandwidth

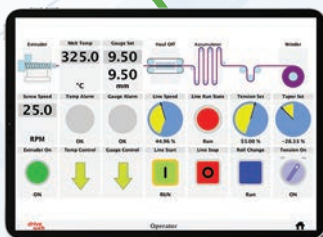

savvyPanel

Integrated touch screen HMI technology

For touch screen PC, Android or iOS devices

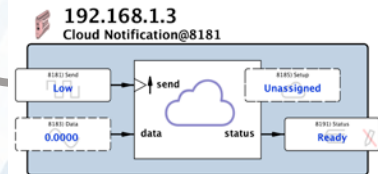

drive.web

drive.web uses distributed control over Ethernet to provide cost effective, high performance integration of drives & controls in systems of any size or complexity.

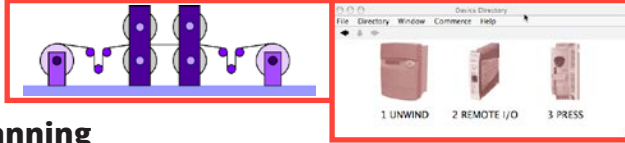

7 Concept & Planning

From your initial sketches and notes create **drive.web savvy** "Phantoms" offline to identify all your drives, remote I/O, MMI interfaces, gateways, etc.

2 Design & Configuration

Place any control function blocks you need then drag & drop between parameters in your "Phantoms" to make all your device interconnections. The **savvy** Signal Flow Diagrams and powerful navigation aids give you a clear intuitive view of your work. Information and help is always on the spot with hover text, links to the manual, and contextual menus.

3 Construction & Testing

Simply connect all your drives and devices together over Ethernet and load your complete design into the devices from just one location. The System immediately comes alive for testing and monitoring.

4 Installation & Operation

Use **drive.web savvy** to provide real time monitoring and control of your entire system from any location. No running from drive to drive to check the setup or operational state! Use **savvyPanel** operator station technology to provide smart touch and roaming control from anywhere.

5 Management & Maintenance

Use **savvy** utilities to setup system performance criteria and monitor your productivity, machine state, and process trends locally or remotely over the internet.

FROM THE INITIAL CONCEPT, THROUGH PLANNING, DESIGN, CONSTRUCTION, TESTING, INSTALLATION, AND OPERATION, THE DRIVE.WEB SAVVY TOOLS PROVIDE ALL THE VISION, INSIGHT, AND HELP YOU NEED FOR A SUCCESSFUL PROJECT!

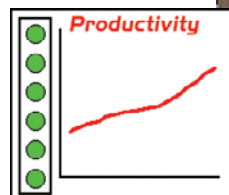
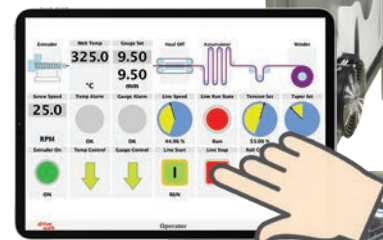

drive.web smart technology ... Designed and built in the USA to International Standards: UL, cUL, CE, FCC, UK CA

smart automation

The innovative **drive.web** technology provides total control in one homogeneous environment with the entire system database resident in the **drive.web** devices.

- Configure & control individual drives & devices
- Design and operate complete drive systems
- Provide fast, peer-to-peer networking over ethernet
- Create clear, graphical signal flow system documentation
- Easily interface to most other drives, MMIs, PLCs, etc.
- Build cost effective systems of any size or complexity
- Add internet accessibility to your system
- Support worldwide enterprise integration

products

savvy Tools

Intuitive, graphical system design and device configuration tools with powerful navigation features, drag & drop connections, trend charting, online help.



savvyPanel Touch Screens

Innovative, touch screen operator station technology that runs on PC or iOS (iPad, iPhone, etc.) & Android. Build clear machine graphics, buttons, switches, meters, and instrumentation and link to your control scheme. Provides multi-user, multi-level, password protected access via WiFi from anywhere to any system.



smarty Universal Controller

A range of DIN mount **drive.web** programmable controllers with peer-to-peer networking over ethernet or stand alone capability and a wide range of I/O and communications options. Intuitive, easy function block configurations are stored on board for instant field access.



speedy Embedded Controller

Miniature, low cost, **drive.web**, programmable controllers for easy embedding in drives & devices. Includes peer-to-peer networking over Ethernet & USB port.



Only 0.91"W x 0.83"H x 1.42"D!



savvy... the smart automation tool.

- Configure drives, controllers & operator stations
- Design & build complete systems of any size or complexity
- Network & operate drives & systems over ethernet
- Provide multi-user, system wide access from anywhere

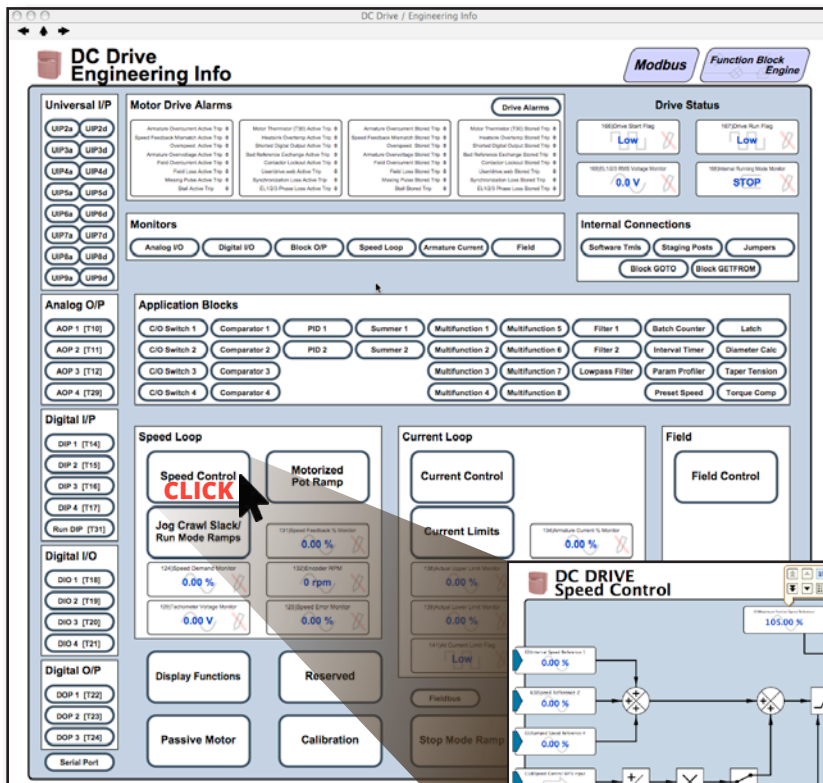

Engineering Info

In Complex products with a fixed set of features, such as drives, an "Engineering Info" window gives an organized overview of the key parameters, I/O, and controls features.

Graphical Function Blocks

Simply click on any function button to drill down to the detailed graphical function block and view or change parameter values.

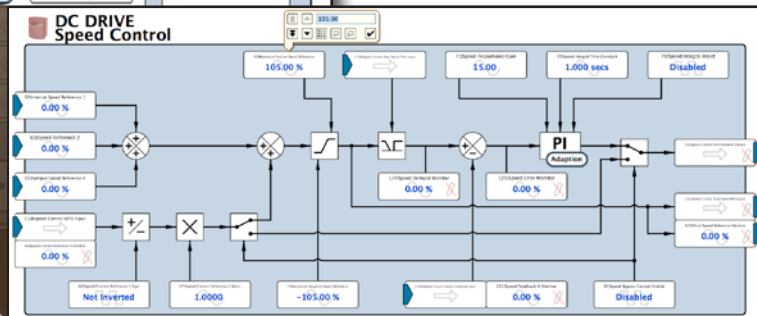

Standard Features

- Online or offline design of drive systems using intuitive tools with pre-engineered function blocks.
- Internet access to drives and systems for remote configuration, monitoring, and process training.
- Provides easy import, export, and cloning of device configurations.
- Dynamic graphics show real time state of switches, indicators, parameter values, etc.
- Low cost, full featured, distributed control capability with peer-to-peer networking.
- Multiple users, local or remote, can have concurrent real-time access to drives or systems.
- Function Block Libraries for winder controls, PID, drive synchronization, arithmetic, logic, etc.
- Deterministic connections provide high performance links between drives, PLCs, Operator Stations, SCADA computer, and other control products.
- "drag & drop" techniques make easy parameter connections between drives, control devices, etc.
- "Dock" feature enables key system parameters to be monitored and trended from one location.
- Powerful navigation features include drill down (to detail layers in drives and controllers), search, connection tags, jump, browse, pan, and zoom for easy visual system comprehension.
- VPN (Virtual Private Networking) for secure Internet connectivity is supported.
- Password protection is provided at many levels for secure use.

Get **savvy** free online: www.driveweb.com

The **savvy** tools and utilities are platform independent and run on Windows, macOS, Unix, Linux, and Solaris and they are all automatically updated as new features before release.

Drives, programmable controllers, operator stations, and complete systems are configured by making simple drag & drop connections between graphical function blocks.

Engineering Info

Anywhere in the system you will have easy instant access to the information you need with several different types of resource...

- Right click on any active object such as a device, connection, parameter, or function block to open the contextual menu.
- “Hover” over any active object and see its key data appear at the top of the window.
- “Hover” over a button to see its function described.
-  Look for the information button. This will jump you to the relevant location in the user manual.
- The “Help” menu links you to the full user manual, and other getting started guides.

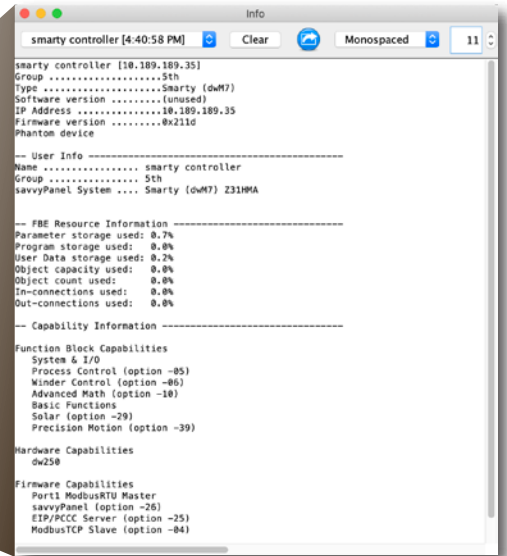

Trend Charting

You can collect any parameters of interest in a “dock” window and display as a trend chart. The trend time scale can be adjusted from 10 seconds to 2 days and the data can be exported in a .csv format for separate spreadsheet analysis. Click on a point of interest to get the instantaneous, time stamped data values.

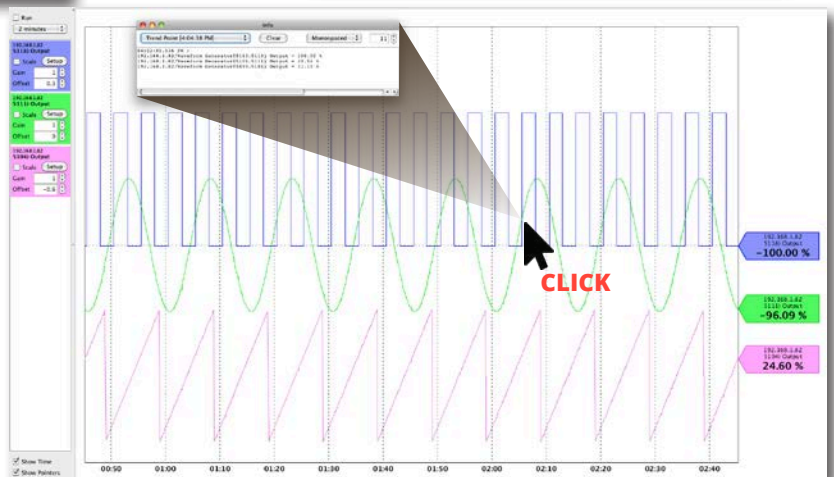

savvy-SFD ... Signal Flow Diagram

The **savvy-SFD** option provides a powerful, graphical, Signal Flow Diagram interface with enhanced system wide navigation and the ability to produce clear, annotated, device and system documentation.

Use **savvy** “phantoms” to create systems which can be downloaded later into the real devices.

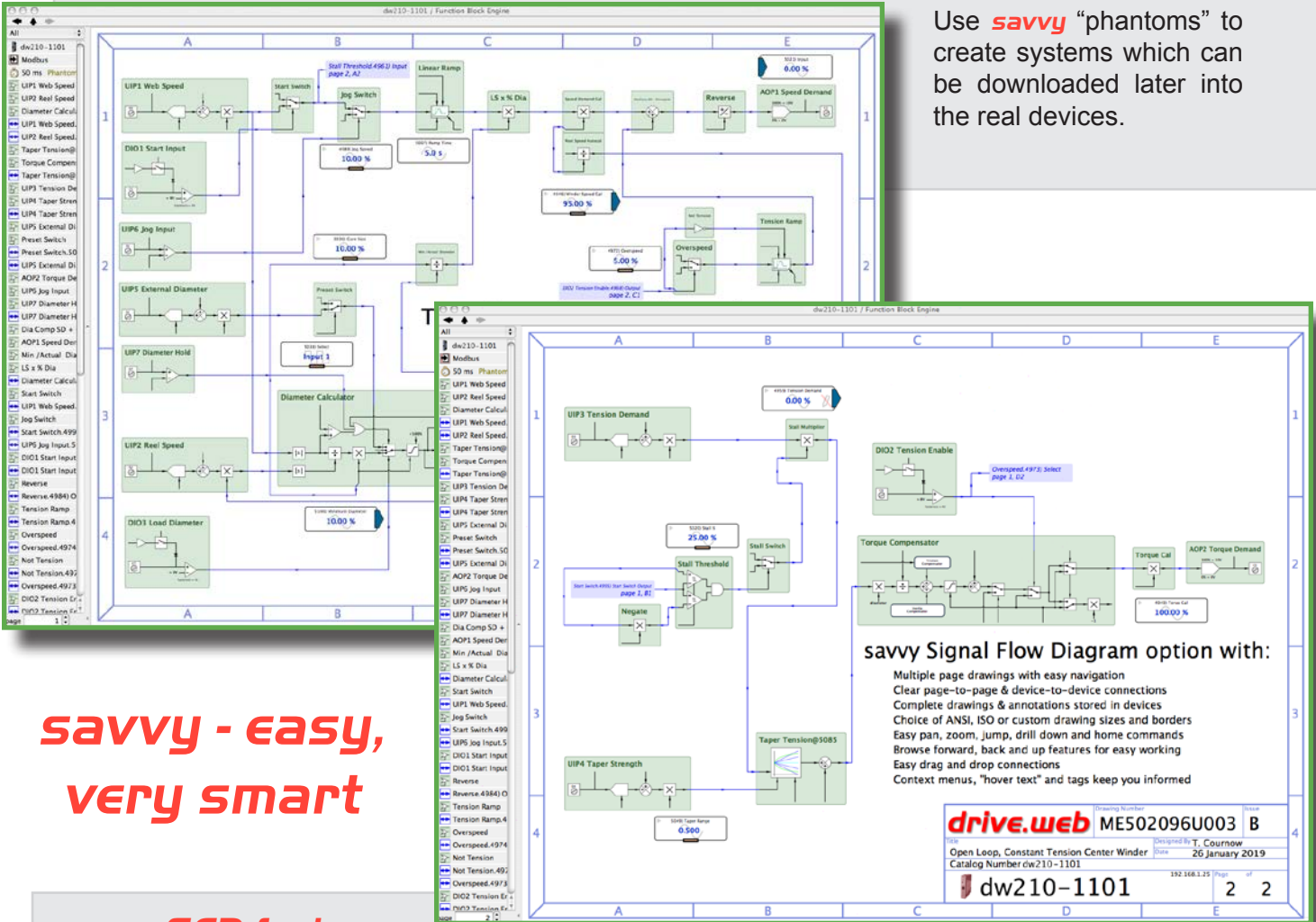

**savvy - easy,
very smart**

savvy-SFD features

- Basic **savvyPanel** operator station functions included
- Create your own customized drawing sheets with choice of ISO or ANSI formats
- Signal flow diagrams provide a clear vision of your control scheme and its functionality
- Tags clearly specify the source, destination and location of connections between multiple pages.
- Entire drawing is stored in the **drive.web** devices for instant access in the field.
- Key parameters can be shown at the Signal Flow Diagram level for enhanced monitoring and control
- Connections are “rubber banded” so that function blocks can be moved on pages or between pages
- Drag and drop connections can be made between any parameter anywhere in a system.
- Drawings can be user annotated.
- Powerful navigation features ensure fast searches and that you will never get lost.
- Password protection is provided at many levels for secure use.

savvy Signal Flow Diagram option with:

- Multiple page drawings with easy navigation
- Clear page-to-page & device-to-device connections
- Complete drawings & annotations stored in devices
- Choice of ANSI, ISO or custom drawing sizes and borders
- Easy pan, zoom, jump, drill down and home commands
- Browse forward, back and up features for easy working
- Easy drag and drop connections
- Context menus, “hover text” and tags keep you informed

drive.web	Drawing Number	ME502096U003	Issue	B
	Designed by	T. Cournow	Date	26 January 2019
	Catalog Number	dw210-1101	192.168.1.25	Page 2 of 2

savvy programming

It could not be easier, whether simply configuring a drive or designing a complete integrated system.

A few simple steps are all that is needed to build a complete control scheme with signal flow documentation that is clear and easy to understand. Powerful navigation tools ensure that you will never get lost!



1 Create "phantom" devices or find real devices in your system in the "Device Directory" window

2 Right click on any device or object to open its contextual menu and get information, change names, import/export data, etc.

3 Click on a "Phantom" or device to drill down to the "Function Block Engine"

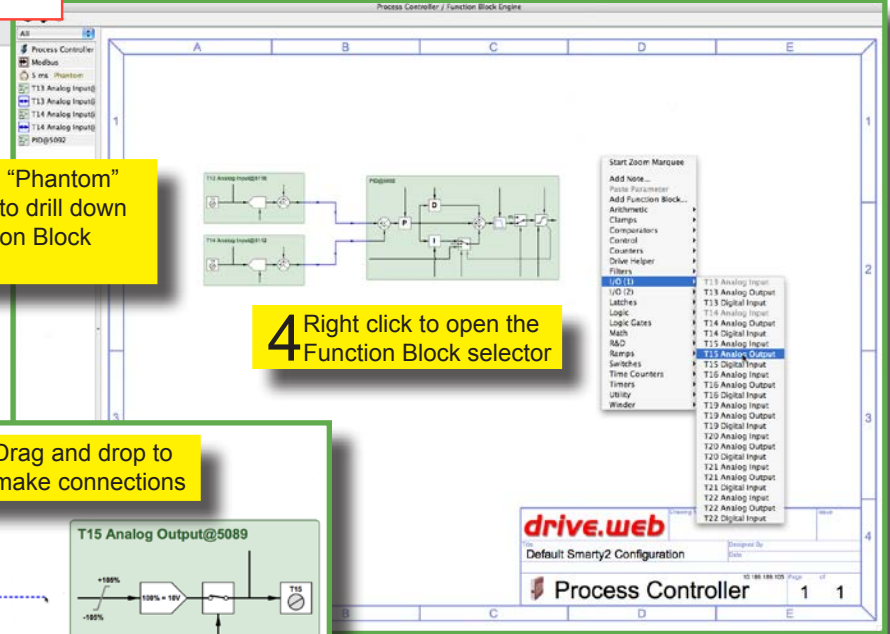

4 Right click to open the Function Block selector

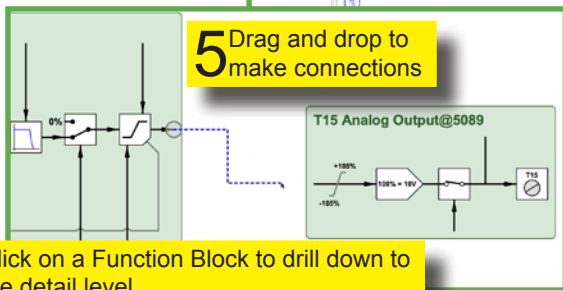

5 Drag and drop to make connections

6 Click on a Function Block to drill down to the detail level

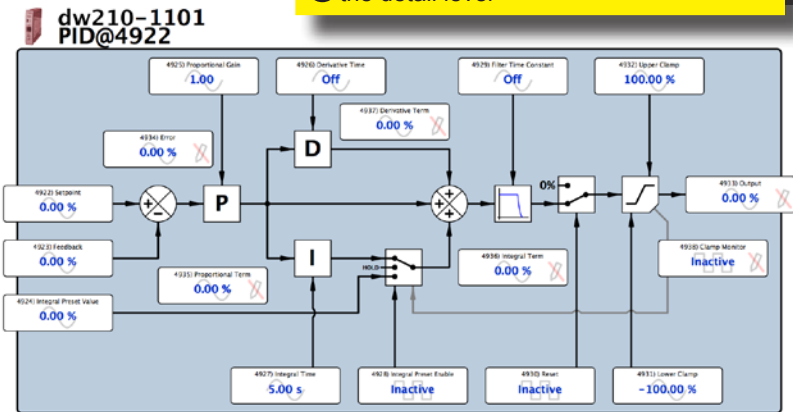

7 Click on a parameter to change its value or state

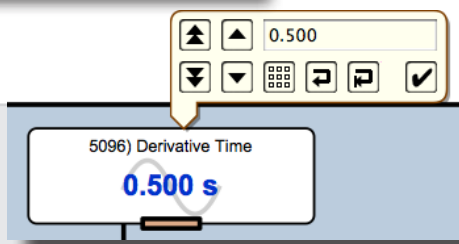

Function Blocks are complete engineered system components. Their graphics are dynamic so that objects such as switches, indicators, etc., show their instantaneous state. A function block such as the PID above includes all the presets, resets, scaling, filters, clamps, etc., that you need for reliable implementation in the real world.

savvy is your smart friend! With a few simple clicks you can build a system, set up a drive and document your work in a thoroughly professional manner - there is no equal!

savvyPanel

Smart, touch screen operator station technology

Provides unprecedented flexibility in instrumentation, control and monitoring.

- Runs native on a **savvyPanel station** high resolution, touch screen display.
- Also runs on any full featured, touch screen PC, Android, and iOS devices (iPad, iPhone, etc.)
- Extensive library of objects such as pushbuttons, switches, meters, indicators, lamps, buzzers, etc.
- Extensive library of graphical image “tiles” to build smart machine and process graphics.
- Machine graphic “tiles” can be linked to detail control screens.
- Full **savvyPanel** configuration is stored in the **drive.web** devices for instant WiFi roaming access.
- Supports multiple screens with multiple pages.
- Provides hierarchal access to system groups, individual systems and multiple operator levels.
- Powerful multi-level password protection.

Example - Extrusion Coating Line

Master System Control Station

Easily build graphics and controls and link them to any location in your drives & control system.

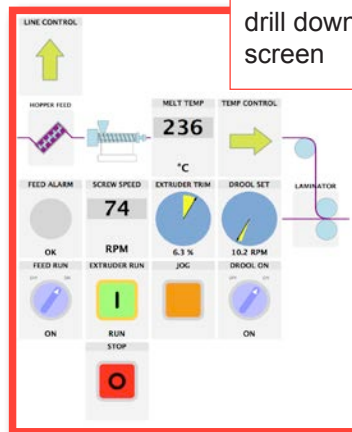
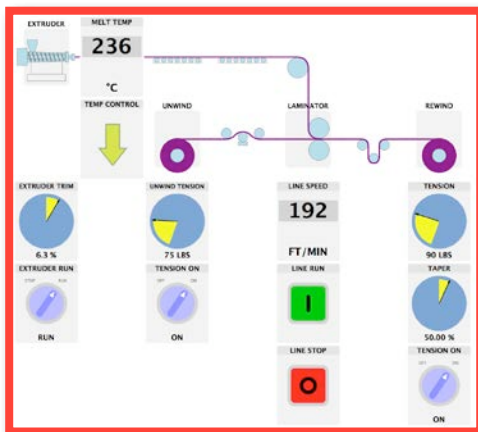

Operator Screen

Touch a graphic tile such as the “EXTRUDER” to drill down to the detail screen

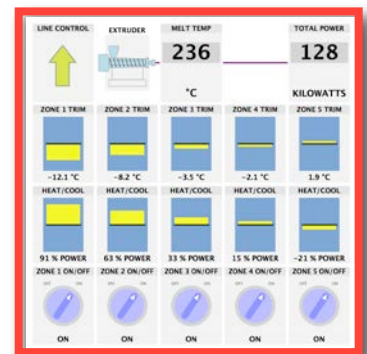

Total Control

Touch the “TEMP CONTROL” arrow link tile to drill down to the temperature control system

Touch the “MELT TEMP” tile in any screen to set the master temperature setpoint.

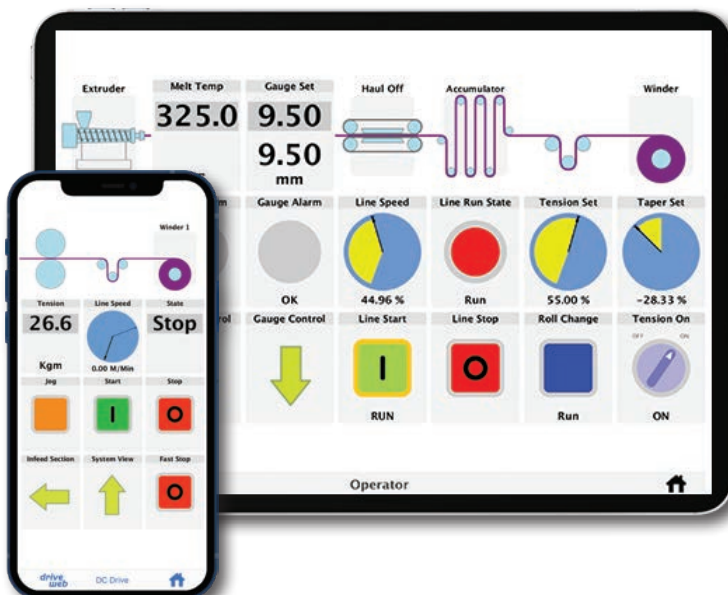

savvyPanel

app for iOS & Android



Go mobile

Get secure machine access anywhere

Try it out now!

Download **savvyPanel** free from the Apple App Store or Google Play Store and get immediate access to a real, live drive system in Stevensville, Maryland, USA.

- ☞ Touch the “Roll Change” button to reset the length to zero
- ☞ Turn on all the section “On/Off” switches
- ☞ Touch the “Line Start” button - see the line run its auto cycle
- ☞ Touch the “Set Speed” indicator to change the line speed
 - ↳ Touch the parameter name to get info
 - ↳ Touch the square display symbol to close the setter

savvyPanel touch *Color Touch Screens*

- Plug & Play, *drive.web* natively
- Competitively priced
- Easy setup
- Crisp, high visibility graphics
- IP65, NEMA 4 splash-proof front
- IP20 rear
- 1 Ethernet port 1000BASE-T
- Power supply 24VDC
- Working Temp: -20°C to 70°C
- Connect directly to any single *drive.web* device or to multiple devices with an Ethernet switch

New!

dw260

7" - bright, 800 x 480p

savvyPanel touch screen operator station

- Easy surface mount - no big cut outs required
- Easy *savvy* programming tools
- Front sealed for indoor use
- *drive.web* Ethernet port for system wide access
- 24V power supply, 6W
- Slim size: 7.9" x 6.6" x 0.8" (200 x 117 x 20 mm)

Optional Mounting Enclosure

dwOPTION-66-070

Gray ABS, 8.75"x5.75"x2.2"
(222x146x56 mm)

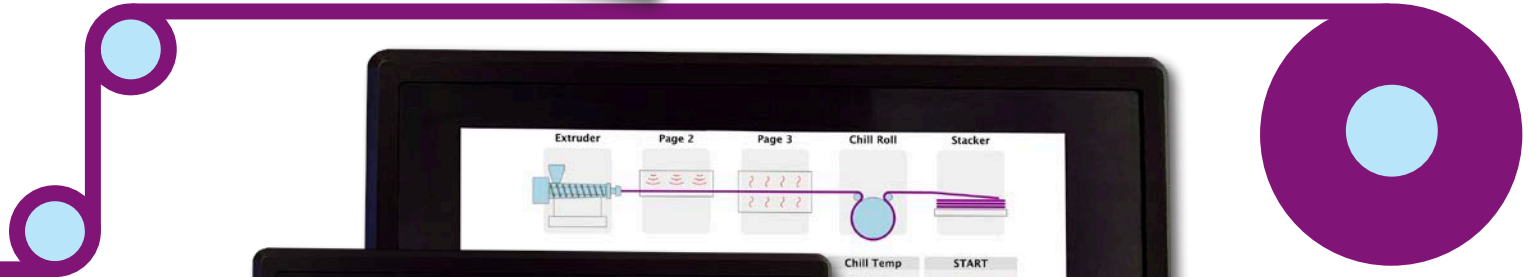

dw230-050 5" - 800x480p 5.9"x4.4"x1.1"

dw230-070 7" - 1024x600p 8.1"x5.5"x1.2"

dw230-097 9.7" - 1024x768p 9.9"x8.1"x1.3"

enclosure for savvyPanel touch

- Impact resistant, flame retardant, polycarbonate industrial enclosure
- NEMA 4 (IP65), light gray.

Dimensions:

5" model dwOPTION-54-052

7" model dwOPTION-54-070

9.7" model dwOPTION-54-097

8.4x5.8x2.2" (213x142x56mm)

9.5x6.3x3.6" (241x160x92mm)

11.8x9.05x3.4" (300x230x86mm)



drive.web Universal Automation Controllers

faster » compact » versatile » expansive » intelligent » easily wirable » ... Available!



Automation Controller

Automation Controller

Automation Controller

Automation Controller

Automation Controller

Full Featured PLC Functions	✓	✓	✓	✓	✓
Advanced Process Control	✓ - Winders	✓	✓	✓	✓
Basic Motion Control	-	✓	-	-	-
Advanced Motion Control	-	-	✓	✓	✓
Extended I/O	-	-	-	-	-
Smart Configuration	-	-	-	-	-
drive.web distributed control	✓	✓	✓	✓	✓
100baseTX Ethernet	✓	✓	✓	✓	✓
Modbus TCP/IP & EIP/PCCC	✓	✓	✓	✓	✓
USB-C port	✓	✓	✓	✓	✓
8 analog inputs: +/- 10VDC	✓	✓	✓	✓	✓
8 analog outputs: +/- 10VDC (unipolar outputs)	✓	✓	✓	✓	✓
8 digital inputs: 24VDC	✓	✓	✓	✓	✓
8 digital outputs: 24VDC	✓	✓	✓	✓	✓
4 status LEDs	✓	✓	✓	✓	✓
24VDC Logic: 16 Inputs & 16 configurable input/outputs	-	-	-	-	-
120/240VAC Logic: 6 x outputs & 10 x inputs (with line/neutral)	-	-	-	-	-
Relay Outputs: 30VDC, 240VAC, 10A: 2 x Form A, 2 x Form C	-	-	-	-	-
4 Precision Analog Inputs: isolated, 2000mV	-	-	-	-	-
Floating-point numbers and math	✓	✓	✓	✓	✓
Battery backup for clock (battery not included)	-	✓	✓	✓	✓
ModbusRTU master (slave optional)	-	✓	✓	✓	✓
Optional drive interface	-	✓	✓	✓	✓
Frequency/events inputs, timing/stepper outputs	-	-	4 selectable inputs or outputs	6 inputs, 7 outputs	6 inputs, 7 outputs
Encoder	-	-	1 encoder, diff. AB	2 encoders, diff. ABZ + reconnect terminals	2 encoders, diff. ABZ
drive.web options included	-04, -05, -25, -26	-04, -05, -06, -10, -25, -26, -29, -39	-04, -05, -06, -10, -25, -26, -29, -39	-04, -05, -06, -10, -25, -26, -29, -39	-04, -05, -06, -10, -25, -26, -29, -39
Core UAC	dw241-BX-C1CD	dw240-DM-C2CD	dw240-DM-C3CD	dw240-DM-C4CD	dw250-DM-S7PD
P2 Vector Drive UAC	-	dw244-DM-C2CD	dw244-DM-C3CD	dw244-DM-C4CD	dw254-DM-S7PD
E3 Industrial Drive UAC	-	dw248-DM-C2CD	dw248-DM-C3CD	dw248-DM-C4CD	dw258-DM-S7PD
CANopen UAC	-	dw249-DM-C2CD	dw249-DM-C3CD	dw249-DM-C4CD	dw259-DM-S7PD
Dimensions (WxHxD)	4.11" x 3.50" x 3.00" (105 x 89 x 76mm)	4.11" x 3.50" x 3.00" (105 x 89 x 76mm)	5.51" x 3.43" x 3.00" (140 x 87 x 76mm)	8.27" x 3.50" x 3.00" (210 x 89 x 76mm)	0.70" x 3.50" x 4.70" (17.2 x 90 x 119mm)

drive.web smart technology ... Designed and built in the USA to International Standards: UL, cUL, CE, FCC, UK CA

drive.web automation

dw250 smarty⁷

Our most advanced Universal Automation Controller yet



Standard DIN Mounting



Alternate Panel Mounting

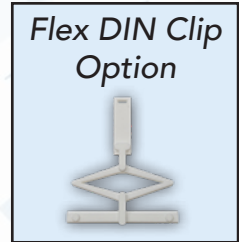

Outperforms any PLC! No Limits!



Features		
USB	USB-C	savvy
Ethernet	8P8C	100baseTX Ethernet
		drive.web & savvy ModbusTCP Client & Server EIP/PCCS Server
Communications	6P6C	CANbus: Bardac P2 & E3, CANopen Client
		EIA-485: ModbusRTU Client or Server Both CANbus & EIA-485 may be active simultaneously
0V	Ground Reference	All 0V terminals connected together
24V	Power In	+24V±5%, consumes ≈ 100mA plus loads
		Supply from a SELV Class 2 LPS (Limited power source) only All 24V terminals connected together
5V	Power Out	+5V±5%, up to 250mA
		Do not apply external power to 5V
LED Indicators	Blue	Power & heartbeat
	Red	Fault
	Yellow	Ethernet link + activity
	Green	Ethernet 100 full duplex
Clock Battery		CR2032 coin cell
		Used only for real-time clock backup Typically only one required per system, if NTP is not available

Inputs and Outputs	
Analog Input	[8] Analog (±10V) inputs 16-bit resolution, ≈100kΩ impedance Also configurable as Digital Input (5V or 24V logic)
Analog Output	[8] Analog (±10V) outputs 16-bit resolution Each AO can source or sink up to 10mA
AB (Encoder Inputs)	[2] Encoder inputs RS-422, RS-485, 5V, 12V, and 24V encoders supported Differential or single-ended 2A & 2B also configurable as marker/event inputs
Digital Inputs	[8] Digital (24V logic) inputs Also configurable as event inputs
Digital Outputs	[8] Digital (24V sourcing) outputs Up to 300mA (shared by all DOs); with overcurrent fault detection Also configurable as Digital Inputs (24V logic)
Frequency Inputs	[6] Frequency Inputs Configurable for 5V logic or 24V logic Configurable for pull-down or pull-up (5V logic only) Configurable as Frequency input, Counter Input, Digital Input, Event Input
Timing Outputs	[7] Timing (sinking) outputs Up to 24V Each TO can sink up to 20mA Configurable as Frequency Output, Stepper Output, or Digital Output TO7 also configurable as a Digital Input, Analog Input (unipolar)
Frequency & Timing Output	FI 1-6 & TO 1-6 share a wiring terminal, labeled FT 1-6

Data	
Dimensions:	0.7" x 3.5" x 4.5" (17.2 x 90 x 119 mm)
Weight:	0.38 LBS (17.3 g)

dw250 smarty⁷-XIO

Universal Automation Controller with Extended I/O

dw250 smarty⁷-XIO automation controllers all include all of the standard **smarty⁷** features with the addition of an extended I/O module.

- Flex mount allows either end mount DIN rail for high density or optional side mount for low profile
- Plug in screw terminals
- Easy monitoring and diagnostics

smarty⁷-XD Extended Digital I/O

model dw250-DM-XDPD

- 16, 5-24VDC Digital Inputs
- 16, 24VDC Digital Outputs also configurable as Digital Inputs
- All I/O have common 0V
- Compact package only 1.0" x 3.5" x 4.8" (27x90x121 mm)

smarty⁷-HV Extended High Voltage Digital I/O

model dw250-DM-HVPD

- 10, 120/240VAC Digital Inputs
- 6, 120/240VAC Digital Outputs
- For use with common power supply lines
- 1.3" x 3.5" x 4.8" (33 x 90 x 121 mm)

smarty⁷-RL Extended Relay I/O

model dw250-DM-RLPD

Four relay outputs rated 120/240VAC or 30VDC, 10 Amps

- 2, Form C (changeover) contacts
- 2, Form A, (single contact, normally open)
- For use with common power supply lines
- 1.4" x 3.5" x 4.8" (36 x 90 x 121 mm)

smarty⁷-XA Extended Precision Analog Inputs

model dw250-DM-XAPD

Four precision analog inputs, each isolated from each other and the controller. Each channel is individually configurable for:

- Thermocouple (most common types supported) with cold junction compensation
- RTD temperature sensor (2, 3 & 4 wire)
- Strain gauge loadcell (Wheatstone bridge type)
- Semiconductor tension transducer, full bridge & half bridge
- mV sensing with ranges from 10mV to 2000mV
- Compact package only 1.0" x 3.5" x 4.8" (27x90x121 mm)



drive.web smart technology ... Designed and built in the USA to International Standards: UL, cUL, CE, FCC, UK CA

drive.web automation

dw250 smarty⁷-T

smart, 4-zone temperature controller

Model: dw250-1200 Series - Quad Temperature Controller

The basic controller comes with all the features of the standard dw250 controller plus:

- 4 zone, isolated temperature controller channels,
- DIN mount with full featured programmable control in every module
- All common thermocouples and RTDs supported
- Cold junction compensation
- Easy, password protected set up
- Easy configurable power controller and chiller output options
- Masses of extra analog and logic I/O in every module
- No backplane restrictions - every module linked peer-to-peer over Ethernet
- No CPU limitations - every module provides parallel processing for infinite expansion
- Seamless integration into systems with drives, PLC, motion control & HMIs
- Add your process details and graphics to the basic Quad Controller display
- Easy data logging, trend charts and smart diagnostics
- Internet accessible with cloud functions
- Communications options include ModbusTCP/IP, ModbusRTU, CANopen, EthernetIP



dw250-1201

Easy **savvy** configuration and set up tools

Use USB-C or Ethernet to connect to **savvy** tools for complete system configuration and documentation - including controllers, drives, HMIs:

- Pair with a **dw260** HMI for both control and set up
- Password protected access to operator and set up levels
- Add internet access
- Get **savvy** tools from <https://driveweb.com/get-savvy/>
- Run **savvyPanel** display on any PC, tablet or phone

Unbeatable!

Easily build complete homogeneous control systems

- Add your complete process system configuration
- Add other temperature controllers and I/O
- Add power controllers and drives
- Add touch screens
- Easy drag & drop connections between all devices
- Powerful logic and signal processing functions
- Internet access and cloud functions
- Everything in one homogeneous environment
- Smart system wide navigation features.

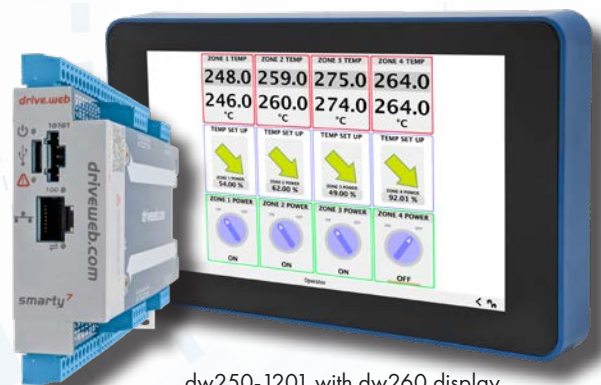

dw250-1201 with dw260 display



dw250-1201 & system with dw260 display

drive.web smart technology ... Designed and built in the USA to International Standards: UL, cUL, CE, FCC, UK CA

dw250 smarty⁷-L

smart, 4-cell tension/load controller

Model: dw250-1300 Series - Quad Tension/Load Controller

The basic controller comes with all the features of the standard dw250 controller plus:

- 4 cell, isolated load controller channels, selectable 10mV to 2048mV
- DIN mount with full featured programmable control in every module
- All common loadcell types supported - LVDT, Strain Gauge, Semi-conductor, Piezo Resistor, Metal Foil. No separate loadcell amplifier required.
- Full bridge and half bridge configurations supported
- Digitally settable zero & cal with password protection on each channel
- Easy configurable controller output options
- Masses of extra analog and logic I/O in every module
- No backplane restrictions - every module linked peer-to-peer over Ethernet
- No CPU limitations - every module provides parallel processing for infinite expansion
- Seamless integration into systems with drives, PLC, motion control & HMIs
- Add your process details and graphics to the basic Quad Controller display
- Easy data logging, trend charts and smart diagnostics
- Internet accessible with cloud functions
- Communications include ModbusTCP/IP, ModbusRTU, CANopen, EthernetIP/PCC



dw250-1301



Easy **savvy** configuration and set up tools

Use USB-C or Ethernet to connect to **savvy** tools for complete system configuration and documentation - including controllers, drives, HMIs:

- Pair with a **dw260** HMI for both control and set up
- Password protected access to operator and set up levels
- Add internet access
- Get **savvy** tools from <https://driveweb.com/get-savvy/>
- Run **savvyPanel** display on any PC, tablet or phone



dw250-1301 with dw260 display

No equal!

Easily build complete homogeneous control systems

- Add your complete machine system configuration
- Add other load controllers and I/O
- Add power controllers and drives
- Add touch screens

- Easy drag & drop connections between all devices
- Powerful logic and signal processing functions
- Internet access and cloud functions
- Everything in one homogeneous environment
- Smart system wide navigation features.



dw250-1301 & system with dw260 display

drive.web automation smarty dw240

smarty¹

smarty²

smarty³

smarty⁴



100% compatible with all existing **speedys**, **smartys**, and **savvyPanels**!

- ✓ Advanced Motion Control
- ✓ Distributed, deterministic processing over Ethernet
- ✓ **savvy** system design tools
- ✓ Easy, intuitive, affordable, expandable
- ✓ Smart Process Control
- ✓ Homogeneous integration for drives, HMIs, remote I/O
- ✓ Right for the IIoT future
- ✓ For systems of any size or complexity

\$\$\$ BIG cost savings with the **smarty dw240** \$\$\$

Example savings, using a **smarty¹** or **smarty²**

smarty eliminates all the wiring, terminals, and hardware normally required to connect your control devices (such as drives, PLCs, etc.) to your enclosure terminals!



The installation cost for either of these **smartys** can be as low as \$20, and the possible savings are huge!

Assuming an average 6ft wire runs from your devices to your terminals, you save:

- Wire, lugs, wire numbers, DIN terminals, terminal numbers, duct, hardware \$83 savings
- Assembly time (4.5 minutes per wire @ \$85/hour) \$235 savings
- Wiring continuity testing (45 seconds per wire @ \$85/hour) \$39 savings

Possible net savings of over \$300!

drive.web **smarty** is powerful!

The **smarty dw240 series** comes fully loaded:

Install a dw240 on the customer interface terminal rail to save on wiring and installation costs!

- Floating point math for accurate and complex calculations.
- Count and Frequency with 64-bit count for precision positioning; to 1MHz input, 500kHz output.
- High speed event inputs for position markers and registration.
- Processing and networking speeds are up to 10 times faster than the dw210, especially with larger configurations.
- Increased storage; four times more capacity.
- Up to six frequency inputs with multiple modes.
- Up to two current inputs; 0 to 20mA, 4-20mA.
- Up to two encoder inputs.
- Up to seven timing outputs with multiple modes to 500kHz; frequency, stepper, and digital.
- Real-time clock with optional battery back up. Low-power mode allows real time clock to run without power from coin cell battery, USB power, or 24-hour internal storage.



Every **dw240** comes fully equipped with dw build options
-04 -05 -06 -10 -25 -26 -29 -39
as standard! (**smarty²** and above)

Call for customized OEM builds!

The **smarty dw240 series** controller consists of a "cassette" that connects directly to system field wiring via four alternative, passive "terminal carriers". This means big installation savings! The **smarty dw240** is available in four models...

smarty¹

basic UAC - 37 terminals - Analog & Digital I/O

Core Stock Build Includes:

100baseTX Ethernet, auto-negotiating,
USB-C

Power: 24VDC

dw build options -04 -05 -25 -26

Clamp Terminals, DIN Rail Mounting

- 8 AI analog in, -11V to +11VDC, 100KΩ, up to 1KHz
(can be used as digital inputs)
- 8 AO analog out, ~0.2 to +10.5VDC, 10mA, up to 1KHz
(can be used as DO or reference voltages)
- 8 DI digital in, 100KΩ, 8V threshold, ±3V hysteresis,
50V max, up to 1KHz (can also be used as event inputs)
- 8 DO digital out, 24V source, up to 350mA (shared), over current protected



dw241-BX-C1CD

only 4.11" wide x 3.5" high x 3.0" deep
(105mm x 89mm x 76mm)

smarty²

advanced UAC - 37 terminals - Analog & Digital I/O

Core Stock Build Includes:

100baseTX Ethernet, auto-negotiating
USB-C

Battery back up for realtime clock

Port options for CAN & ModbusRTU

Power: 24VDC

dw build options -04 -05 -06 -10 -25 -26 -29 -39,

Master Modbus RTU (unisolated),

Clamp Terminals, DIN Rail Mounting

- 8 AI analog in, -11V to +11VDC, 100KΩ, up to 1KHz
(can be used as digital inputs)
- 8 AO analog out, ±10.5VDC, 10mA, up to 1KHz
(can be used as DO or reference voltages)
- 8 DI digital in, 100KΩ, 8V threshold, ±3V hysteresis, 50V max,
up to 1KHz (can also be used as event inputs)
- 8 DO, digital out, 24V source, up to 350mA (shared),
internally current limited



dw240-DM-C2CD

only 4.11" wide x 3.5" high x 3.0" deep
(105mm x 89mm x 76mm)

drive.web smart technology ... Designed and built in the USA to International Standards: UL, cUL, CE, FCC, UK CA

smarty³ advanced UAC - 61 terminals - with encoder and steppers

Core Stock Build Includes:

100baseTX, auto-negotiating,
USB-C

Battery back up for realtime clock

Port options for CAN & ModbusRTU

Power: 24VDC

dw build options -04 -05 -06 -10 -25 -26 -29 -39

Master Modbus RTU (unisolated)

Clamp Terminals | DIN Rail Mounting



dw240-DM-C3CD
only 5.51" wide x 3.43" high x 3.0"
deep
(140mm x 87mm x 76mm)

- 8 AI analog in, -11V to +11VDC, 100K Ω , up to 1KHz (can be used as digital inputs)
- 8 AO analog out, ± 10.5 VDC, 10mA, up to 1KHz (can be used as DO or reference voltages)
- 8 DI digital in, 100K Ω , 8V threshold, ± 3 V hysteresis, 50V max, up to 1KHz (can be used as event inputs)
- 8 DO digital out, 24V source, up to 350mA (shared) internally current limited
- 4 FT Frequency/Timing
Frequency/event input: 5V max, up to 100KHz
Frequency/Stepper output: 5V sinking, up to 350mA (shared)
F inputs can be used as event inputs or digital inputs
F outputs can be used to generate frequency to 500kHz, control stepper amplifiers or as digital outputs
- 1 AB Encoder, differential inputs (5.5V max), up to 1MHz

smarty⁴ advanced UAC - 103 terminals - with encoders, steppers, and more!

Core Stock Build Includes:

100baseTX Ethernet, auto-negotiating
USB-C

Battery back up for realtime clock

Port options for CAN & ModbusRTU

Power: 24VDC

dw build options -04 -05 -06 -10 -25 -26 -29 -39

Master Modbus RTU (unisolated)

Clamp Terminals | DIN Rail Mounting



dw240-DM-C4CD
only 8.27" wide x 3.5" high x 3.0" deep
(210mm x 89mm x 76mm)

- 8 AI analog in, -11V to +11VDC, 100K Ω , up to 1KHz (can be used as digital inputs)
- 8 AO analog out, ± 10.5 VDC, 10mA, up to 1KHz (can be used as DO or reference voltages)
- 8 DI digital in, 100K Ω , 8V threshold, ± 3 V hysteresis, 50V max, up to 1 KHz (can also be used as event inputs)
- 8 DO digital out, 24V source, up to 350mA (shared), internally current limited
- 2 CI Current Input, 4-20mA, 0-20mA, 20-4mA, 20-0mA, 100 Ω
- 6 FI Frequency in: up to 100KHz, 30V max, 100K Ω with pull-up or pull-down. Can be event or digital inputs.
- 7 TO Timing Output, up to 500KHz, 30V max, sinking, pull-up, up to 350mA (shared). For frequencies, steppers or DO
- 2 ABZ Encoders, EIA-422/485 differential (5V max), up to 1MHz
- 2 AB Reconnect terminals for encoders

speedy Automation Controller

Embedded & Onboard Control

Affordable distributed control for all devices

Serial interface on-board to drives and third party devices via ModbusRTU or CANopen to provide:

- Low cost, peer-to-peer Ethernet networking
- Full featured programmable control functions.
- Improve system performance by reducing your RS485 load
- Parallel processing provides extra system performance & memory
- Ethernet gateway to ModbusRTU or CANopen

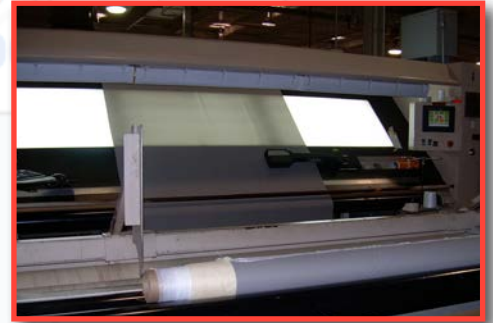

Film line winder

small package with big performance!

Includes USB port for system wide programming, Ethernet ModbusTCP/IP and **savvyPanel** interface. Available forms:

- Tether interface with either plug-in or 4-wire serial connection
- Optional DIN rail mount.
- Customized forms for embedding into drives and devices



Cyclic indexing system

configure, connect & control ... everything!

- Provides full featured **savvyPanel** operator station interface
- Add unlimited processing muscle to your system
- Add peer to peer Ethernet networking
- Add easy USB system access
- Use as a gateway

speedy

model dw270 series
take a closer look ...

for embedded or onboard
control

only 0.9" x 0.9" x 2.4"
(23x23x62mm)



speedy

model dw221
embedded controller for
PL/X Series DC drives



smarty dw210 - Universal Automation Controllers

100% compatible with new dw240 and dw250

Smart controllers, DIN mount with 100baseTX Ethernet distributed control, USB port and wide range of I/O & communications options

16 standard I/O, each configurable as:

- 8: $\pm 10V$, 16 bit analog in or out or 24V digital in
- 8: 0-10V, 16 bit analog in or 24/12/5V dig in or 24V dig out, source or sink

dw210 smarty for standalone or networked applications

General purpose programmable controller or drive interface controller



0.91" w x 4.09" h x 4.72" d (23 x 104 x 120 mm)



See page 26 for other drive and device integration apps

speedy dw220 series



0.91" x 0.83" x 1.42"
(23 x 21 x 36 mm)



DIN mount dwOPTION -50

Mini smart controllers for use on-board or embedded in drives & devices with **drive.web** distributed control over 100baseTX Ethernet, ModbusTCP/IP, USB port, fast serial port (up to 500kbps), full-featured savvyPanel HMI, & communications options

- dw220 speedy** generic interface controller with 500kbps ModbusRTU master & 15" wire interface
 - dw221 speedy** plug-in automation controller for PLX Series DC drive
 - dw222 speedy** plug-in automation controller for ODE2 General Purpose VFD
 - dw223 speedy** plug-in automation controller for ODP Sensorless Vector drive
 - dw224 speedy** plug-in automation controller for P2 Closed Loop Vector drive
 - dw224S speedy** plug-in automation controller for SEW Eurodrive MLTP Closed Loop Vector drive
 - dw225 speedy** automation controller for Yaskawa F7 drive with 7" wired interface
 - dw228 speedy** plug-in automation controller for E3 Series General Purpose drive
 - dw229 speedy** automation controller with generic CANopen device with 7" wired interface
- see page 26 for other drive and device integration apps

Easy, on-board & embedded automation for drives & devices
Very small, very smart, very affordable
Goes anywhere - does everything!



High performance film winder



21 section embossing line



Airport transit car load sharing system

Model Numbers



smarty & speedy Product build options

		smarty			speedy								
		dw210	dw240	dw250	dw220	dw221	dw222	dw223	dw224	dw225	dw228	dw229	dw27X
Function Block Libraries													
-05	Advanced Process Control Function Block Library (FBL) (comparators, profilers, presets, latches, filters, counters, timers, PIDs)	X	S	S	X	X	X	X	X	X	X	X	S
-06	Winder Control FBL (dia. calc., taper tension, torque comp.)	X	S	S	X	X	X	X	X	X	X	X	S
-10	Advanced Math FBL (trigonometric, log, exponential)	X	S	S	X	X	X	X	X	X	X	X	S
-11	Encoder Control FBL (shaft lock, indexing, registration for Options 40-44)	X											
-29	Solar FBL with sun position calculator	X	S	S	X	X	X	X	X	X	X	X	S
-35	Utility / Cloud Notification		X	X	X	X	X	X	X	X	X	X	X
-36	Motion Control FBL with Trapezoidal Motion & Cam Profile	X											
-39	Precise Motion Control FBL with Linear Positional, Shaft Lock, etc.		S	S	X	X	X	X	X	X	X	X	S
Communications Options													
-04	Ethernet Modbus TCP/IP slave	X	S	S	S	S	S	S	S	S	S	S	S
-25	Ethernet EIP/PCCC interface for AB PLCs	X	S	S	X	X	X	X	X	X	X	X	S
I/O Options													
-26	savvyPanel iPad/iPhone/Android & touch screen PC operator station interface	X	S	S	S	S	S	S	S	S	S	S	S
Mounting Options													
-50	DIN rail mount with screw terminal connections				X					X		X	X

X = Optional Add-on S = Standard feature

smarty & speedy - stock controller options (un-configured)

pack 1 - speedy & smarty dwOPTION -1121 for

- Process line drive coordination
- General purpose machine control

Includes all standard controller features together with:

advanced arithmetic, logic, process control, counters, timers, touch screen PC, iOS & Android control, systems utilities

Incorporates standard *drive.web* options

- 04, ModbusTCP/IP slave Ethernet
- 05, Advanced Process control Function Block Library
- 25, EIP/PCCC Ethernet slave for Allen Bradley interface
- 26, **savvyPanel** full featured, touch screen PC, iOS & Android operator station controller



pack 2 - speedy & smarty dwOPTION -1122 for

- Full featured winder control with single or multi cores, turret indexing, auto splicing, open and closed loop, edging
- Web handling, tension control, accumulators, infeeds, center winding, slip core, surface winding

Includes all pack 1, dwOPTION -1121 features together with:

diameter calculation, linear and hyperbolic taper control, static/dynamic friction compensation, inertia compensation

Incorporates standard *drive.web* options

- 04, ModbusTCP/IP slave Ethernet
- 05, Advanced Process control Function Block Library
- 06, Winder Control Function Block Library
- 25, EIP/PCCC Ethernet slave for Allen Bradley interface
- 26, **savvyPanel** full featured, touch screen PC, iOS & Android operator station controller
- 36, Motion Control Function Block Library with trapezoidal & cam motion



drive.web smart technology ... Designed and built in the USA to International Standards:
UL, cUL, CE, FCC, UK CA

Free Online Training Videos

The **drive.web savvy-SFD** Introductory Seminar provides an overview of the **drive.web** distributed control technology and its products.

In this video, new users can expect to learn how to:

- Create a “phantom” drive system with AC & DC drives
- Navigate around drive block diagrams and drive systems
- Create signal flow diagrams & system documentation
- Find information and identify object attributes
- Make connections between devices
- Monitor and set parameter values
- Create and use parameter “docks”
- Show parameter value trend charts, etc.

PL/X Series Training

Configuration | Monitoring | Interfacing



Scan QR for free resources



P2 Series Training

V/Hz Mode | Open Loop | Closed Loop

More scheduled training videos are upcoming! Please watch for announcements.

drive.web device apps

These apps can be installed in **drive.web speedy** and **smarty** Universal Automation Controllers to provide a plug & play interface to the key features of “*other*” drives or devices. The **smarty** or **speedy** then brings those “*other*” drives alive with:

- Full featured programmable control functions
- Ethernet networking
- USB port access

“*Other*” devices include almost any device that has a ModbusRTU port, including:

- AC drives • DC Drives • PLCs • Process Controllers •
- Temperature Controllers • Smart I/O • Power Controllers •

Current “*Other*” device app list includes:

dwOPTION -4001 for Yaskawa A1000 Drives (with dwOPTION-1121)
dwOPTION -4002 for Yaskawa V1000 Drives (with dwOPTION-1121)
dwOPTION -4003 for V2 Series Fan & Pump Drives
dwOPTION -4004 for Schneider Altivar 312 Series Drives
dwOPTION -4005 for ABB ACS310 Series Drives
dwOPTION -4006 for Sanyo Denki Stepper Drives
dwOPTION -4007 for Thermal Edge Temperature Controllers
dwOPTION -4008 for V3 Series Eco Drives
dwOPTION -4009 for Fuji Frenic Mega Vector Drives
dwOPTION -4011 for Yaskawa A1000 (with dwOPTION-1124)
dwOPTION -4012 for ABB ACS310
dwOPTION -4013 for Fairford Electronics Synergy Soft Start

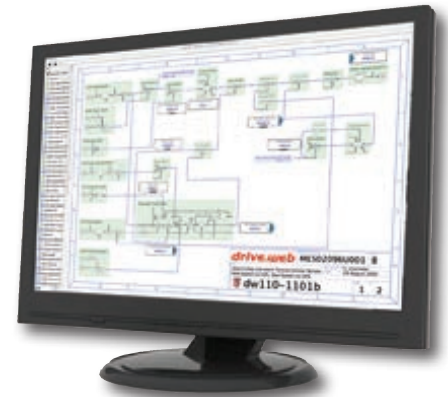

drive apps come complete with a user guide and application notes.

The configurations can easily be edited and additional drive parameters can be added using only the **savvy** tools.

These **drive.web device apps** are easy for us to create, so don't hesitate to contact if you have a new request.

Please call +410-604-3400 for the latest list or a new “*other*” app.

drive.web apps

CONFIGURED OPTIONS FOR *smarty* & *speedy*

These options are pre-programmed units with generic solutions for key applications. The packages are a great design aid.

These generic configurations are easily edited to suit your specific installation using *savvy* with the *SFD* Signal Flow Diagram option and include the following features:

- detail signal flow diagram documentation
- *savvyPanel* touch screen PC, iOS & Android operator station configuration
- basic wiring drawing



smarty

speedy

ADD CONFIGURED OPTIONS

- 1101 Open loop constant tension center winder (with option 1122)
- 1102 Closed loop dancer controlled winder (with option 1122)
- 1103 Closed loop load cell controlled winder (with option 1122)
- 1104 Slip core winder controller (with option 1122)
- 1105 Speed lock w/encoder feedback
- 1106 Coordinated drive, line master controller (with option 1121)
- 1107 Controller with networking for analog drives (with option 1121)
- 1109 Phase lock, line shaft with registration
- 1110 Three PID Controllers with integral reset and hold (with option 1121)
- 1113 2 channel pulse train follower (with options 05, 26, 27)
- 1117 Encoder cyclic position/indexing
- 1118 Sun tracking for solar energy (with opts 05, 11, 16, 26, 29, 42 & 45 or 46)
- 1131 Encoder analog out, T13, Calibrated 1024PPR @1800RPM = 10V
- 1132 Time control programmer (with option 1121 + 47)

	dw210	dw240	dw250	dw220	dw221	dw222	dw223	dw224	dw225	dw228	dw229	dw27X
-1101	X	X	X	X	X	X	X	X	X	X		X
-1102	X	X	X	X	X	X	X	X	X	X		X
-1103	X	X	X	X	X	X	X	X	X	X		X
-1104	X	X	X	X	X	X	X	X	X	X		X
-1105		X	X									
-1106	X	X	X	X	X	X	X	X	X	X		X
-1107	X	X	X									
-1109			X									
-1110	X	X	X									
-1113		X	X									
-1117		X	X									
-1118		X	X									
-1131		X	X									
-1132		X	X	X			X	X	X	X	X	X

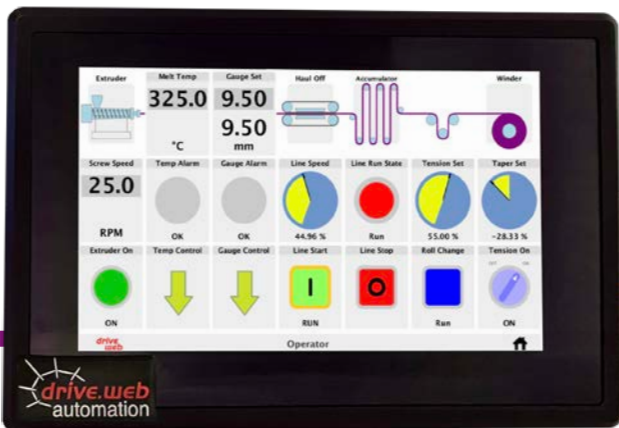

drive.web accessories

- Industrial Ethernet switches
- Wireless access points
- Interconnection cables, connectors
- Communications gateways
- Touch screen PCs
- *drive.web* software & firmware upgrade vouchers

Please call +410-604-3400 for details

drive.web automation

drive.web apps

WINDERS & UNWINDERS

smarty automation controllers use the **drive.web** distributed control systems to bring easy, cost effective intelligence to high performance drive systems.

smarty apps are pre-configured generic packages for common applications:

- smarty** OPTION-1101 Open Loop Constant Tension Center Winder
- smarty** OPTION-1102 Closed Loop Dancer Controlled Center Winder
- smarty** OPTION-1103 Closed Loop Load Cell Controlled Center Winder
- smarty** OPTION-1104 Closed Loop Slip Core Winder



web handling excellence

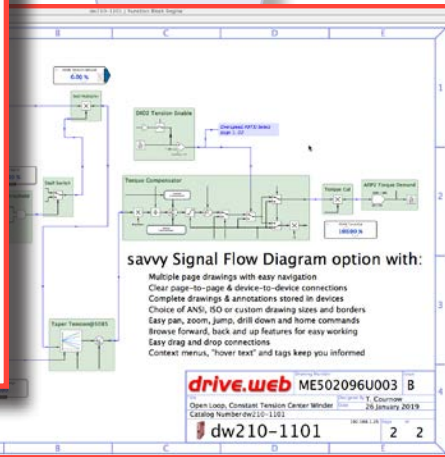
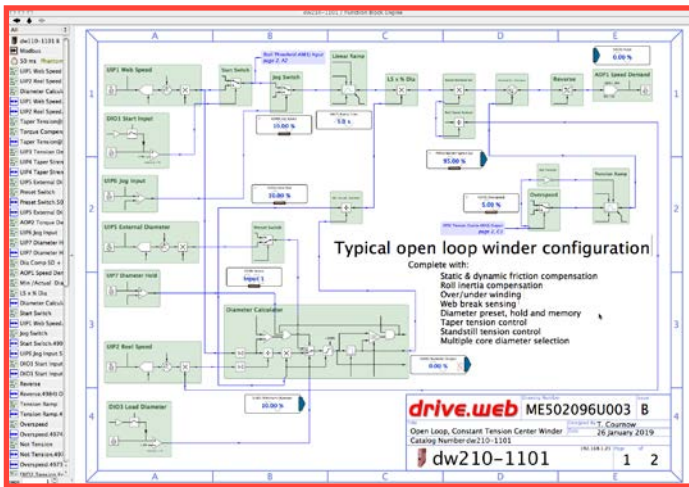

These generic configurations can easily be edited by the intuitive **drive.web savvy** graphical tools to suit the particular application. The clear signal flow diagrams are stored in the controllers for reliable access in the field.

smarty OPTION-1101 OPEN LOOP CENTER WINDER

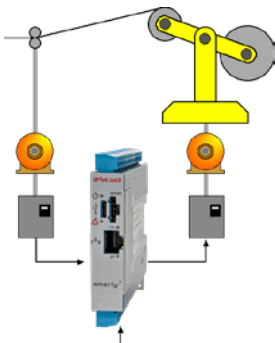

smarty OPTION-1102 DANCER CONTROLLED CENTER WINDER

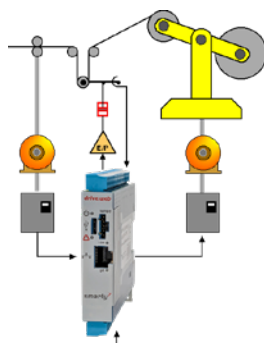

smarty OPTION-1103 LOAD CELL CONTROLLED CENTER WINDER

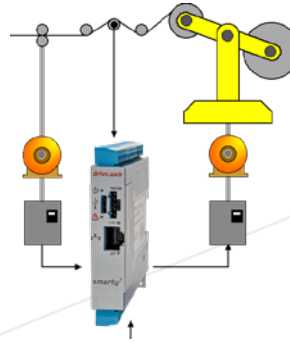

savvyPanel touch screen control

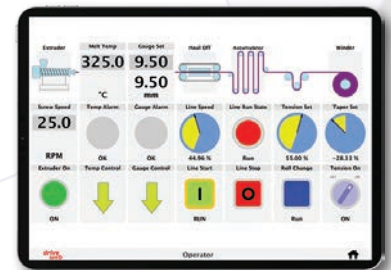

Standard features include:

- Fully editable configurations and drawings
- Drive Interface either serial port or analog
- Process control & winder function block libraries
- Web break sensing
- Diameter calculation, memory, preset and hold
- Linear or hyperbolic taper tension
- Friction, inertia & torque compensation
- Multiple core presets
- Integral reset
- Adaptive control for high speed systems
- Standstill tension mode
- Jog/run/slack take up modes
- Turret indexing mode
- Anti-reverse clamps
- Core speed matching

Optional features include:

- Over/under winding
- Line drive coordination
- Manual or auto-splicing modes
- Turret indexing
- Air pressure control
- Length & mass calculation
- Edge guide control
- Encoder inputs
- Modbus/TCP/IP over Ethernet
- Serial communications
- ... and more.



smarty app OPTION-1106 Process Line Coordination

Standard function blocks used in combinations of *smartys* and *speedys* can be easily configured to provide line drive coordination in systems of any size or complexity.

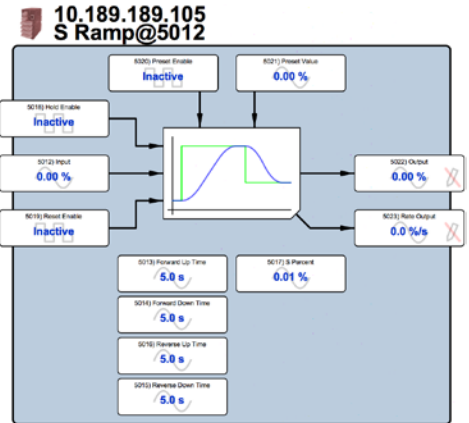
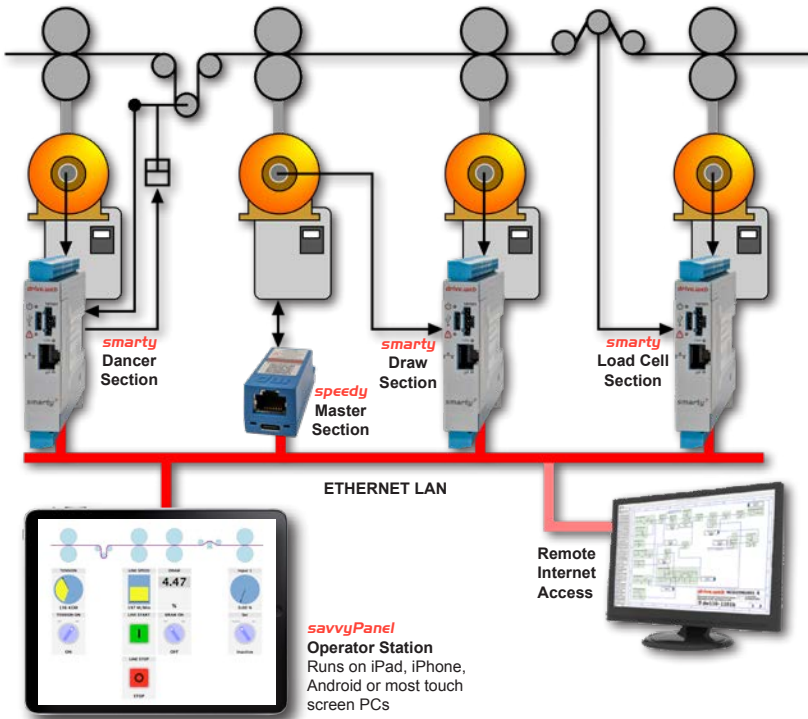

- Functions such as linear, S and hyperbolic ramps are used to provide master references.
- Programmable logic and switch functions are used to provide line run, line jog, local jog, interlocks, etc.
- PIDs, profilers, registration, indexing, phase lock and arithmetic blocks provide precise section control.

smarty app OPTION-1109 Registration & Electronic Line Shaft

The Registration & Electronic Line Shaft package is designed for applications such as print registration, synchronized component handling, position control, cut-to-length, etc., where precision drive coordination and spindle orientation are required.

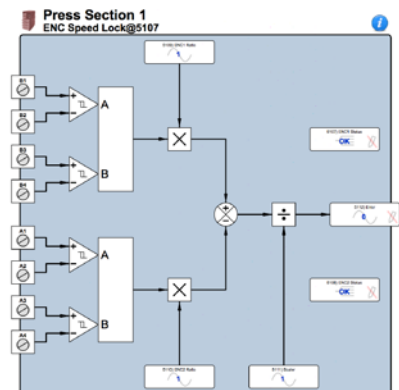
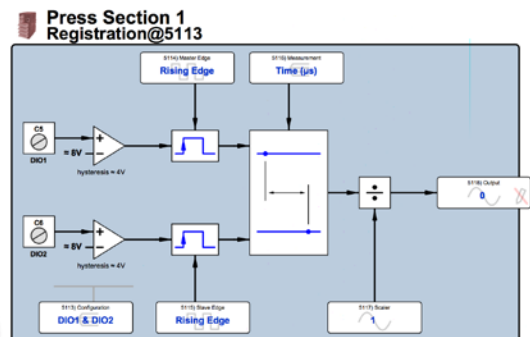
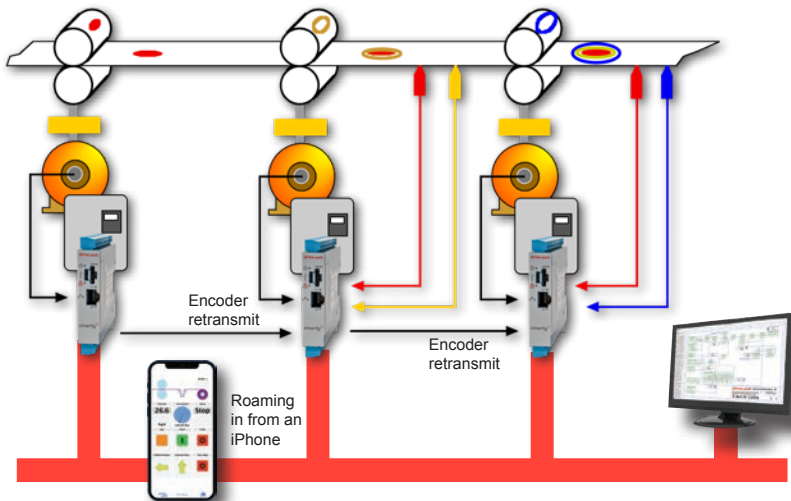

Standard graphical function blocks for registration and speed locking make these complex processes quick and easy to configure and use. The encoder retransmit option provides buffered encoder signals for secure use in multiple locations.

For multi-axis motion control of all types of drives - AC drives, DC drives, servos, steppers, hydraulic, linear actuator, etc., in a wide variety of general industrial position control applications including:

- Pick & place machines
- Packaging machines
- Painting robots
- Cut to length
- Automated assembly processes

Trapezoidal Motion

A key requirement for numerous machine controls

Key Features:

- Continuous target recalculation
- Easy system set up
- Easy performance optimization
- Pause with controlled accel/decel
- Hold with fast stop

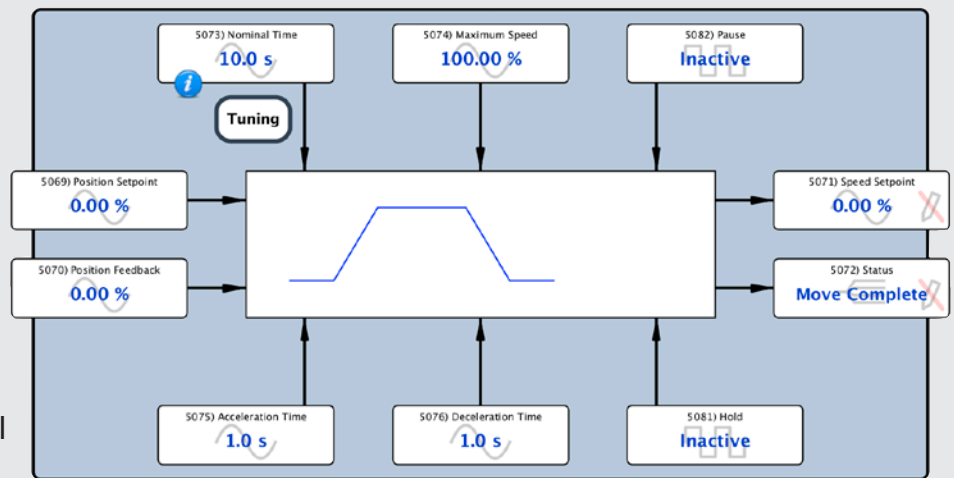

Cam Profile

A key requirement for numerous machine controls

Key Features:

- Easy graphical profile editor
- Optional .csv file import
- Easy .csv file export
- Easy system set up
- Easy integration with multiple axes
- Up to 100 “knots” or points for complex profiles
- 16 bit signed input and output resolution for accurate cam forms

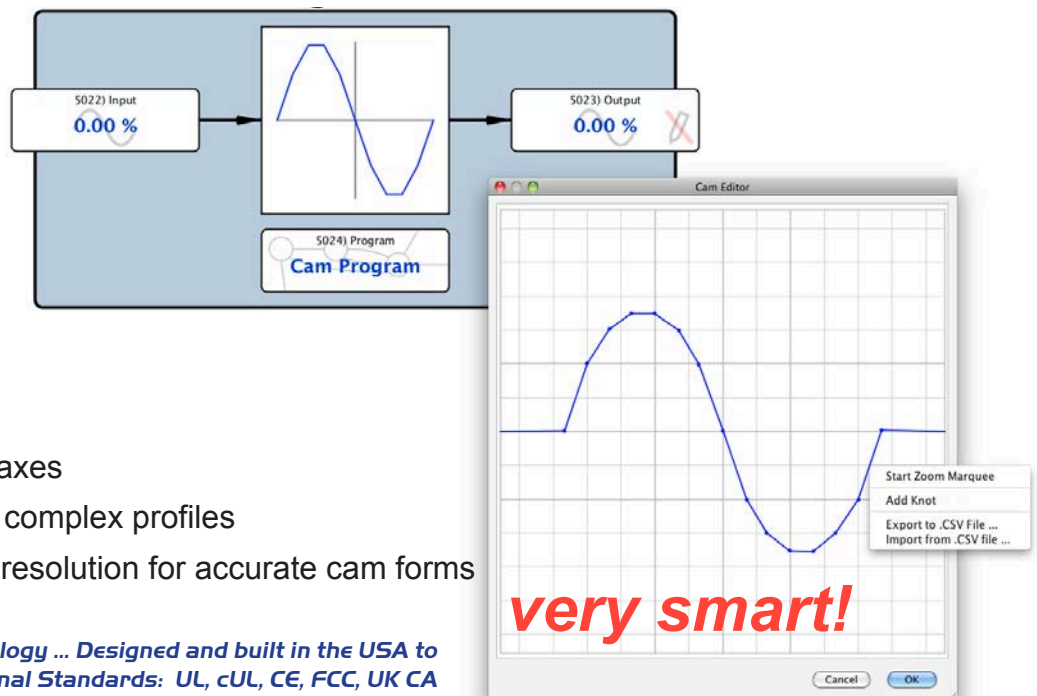

drive.web smart technology ... Designed and built in the USA to International Standards: UL, cUL, CE, FCC, UK CA

motion control Stepper Drive Controllers

These stepper drive controller options are available for most versions of the **smarty** (see option selection table, page 25).

Both options include:

- 2 channels of pulse & direction
- 2 fast event inputs for count reset
- 64 bit pulse counts
- Automatic datum reset
- Easy set up
- Selectable count persistence with “clear on power up”

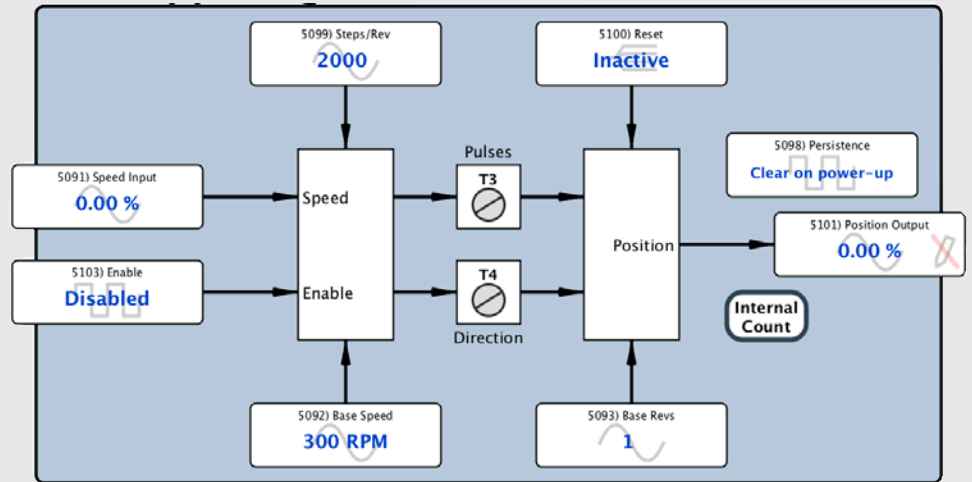

dwOPTION -37 Open Loop Stepper Drive Controller

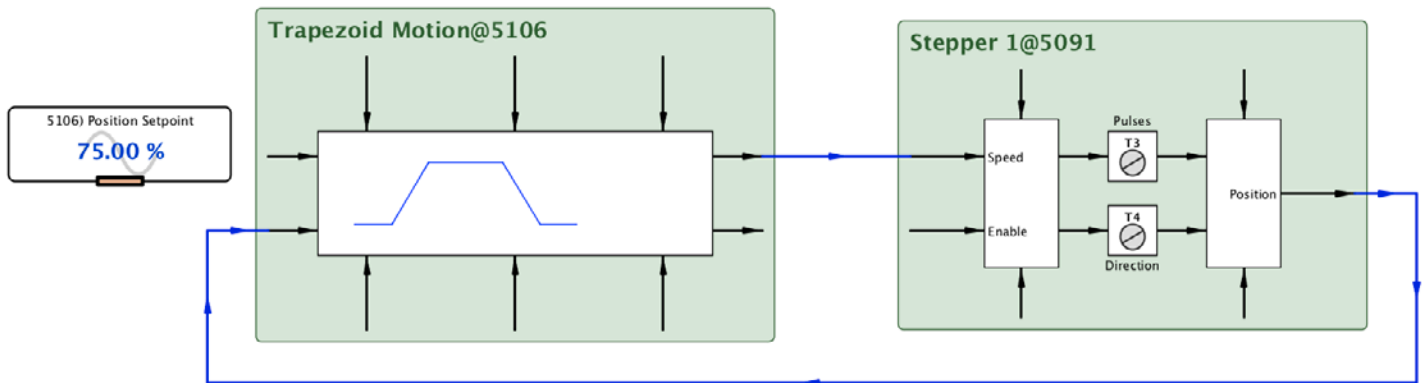

In a typical open loop stepper drive application the “Position” parameter (derived from the pulse count) can be used to close the position control loop.

dwOPTION -38 Closed Loop Stepper Drive Controller

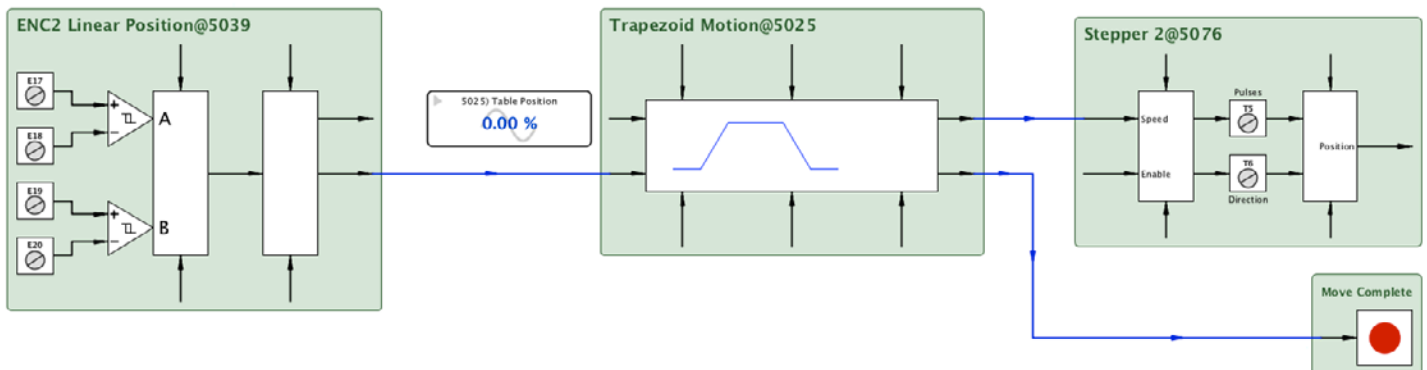

In a typical closed loop stepper drive application the position feedback can be provided by an encoder. The dwOPTION-42-45 encoder module also has two fast event inputs for auto count reset.

smarty app OPTION-1117 Indexing & Cyclic Positioning

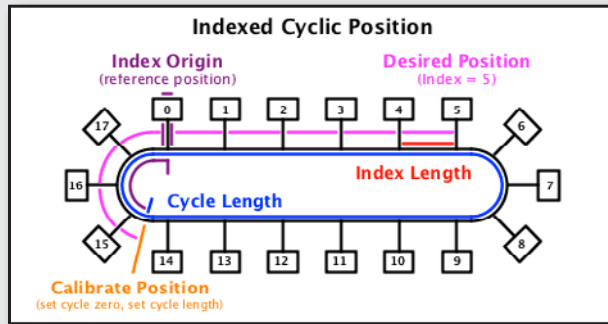

The optional Encoder Function Block Library available in the **smarty** includes a set of engineered function blocks for use in precision positioning applications such as packaging machines, machine center tool loaders, inventory carousels, stackers, etc.

Key Features

- Auto origin checking
- Auto index calculation
- Auto calculation of shortest move from point to point
- 64-bit encoder counts

smarty app OPTION-1118 Sun Position Calculator

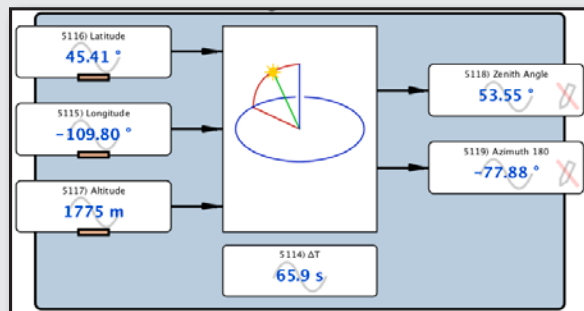

The Solar Function Block Library provides precise calculation of the sun zenith and azimuth angles in solar energy systems. It can be synchronized with the SNTP server time and date and include a ΔT input parameter to compensate for the difference between UTC and Terrestrial Time for precise positioning of solar concentrators.

Key Features

- Set up for any latitude, longitude and altitude.
- Fast calculation for use in mobile systems.
- SNTP synchronization support.
- Terrestrial Time correction input.

smart function blocks

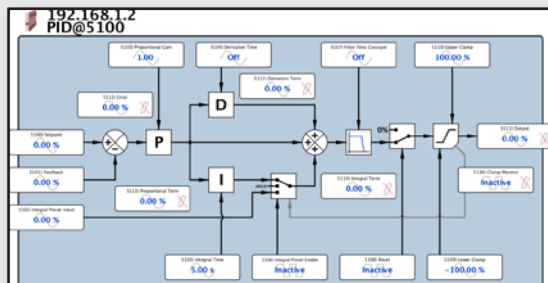

smart PID

One of the most commonly required functions in industrial control.

In most PLCs you get the basics but you are left to sweat the details required to make it work reliably in the real world. We cover the bases by including, integral preset, reset and hold, output filter, upper and lower clamps.

Saves a lot of time and heartache!

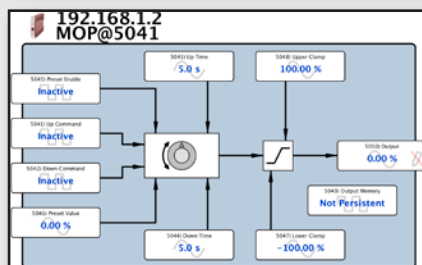

Motorized Pot

This MOP block makes short work of figuring out all the functions you need for raise/lower push button control

No sweat!

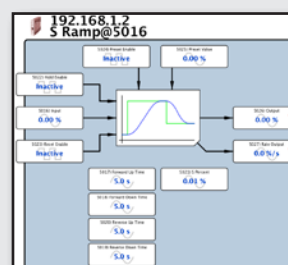

S-Ramps

Ever tried to create an S-Ramp that works predictably in a typical PLC? We make it easy, intuitive and reliable!

No problem!

smart utilities cloud functions

The Cloud Notification function block available in every **drive.web** device enables you to send alerts, event notices, status reports, etc., to management, quality controllers, plant engineers in any location.

It is easy to set up and it ensures that key process issues are delivered to the right place at the right time.

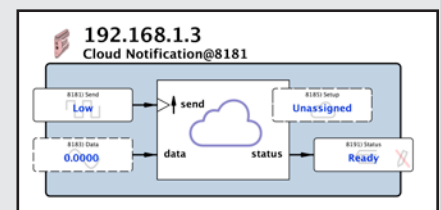

smart function blocks State Machine Logic

Logic made easy and reliable!

This powerful, Intuitive, 21st. century technology takes the stress out of logic programming. It's very simple ..

1. Define your machine states such as STOP, RUN, JOG, FAST STOP, etc.
2. Define the transitions that get you from one state to another, for example:
 START button gets you from STOP state to RUN state
 JOG button takes you from STOP state to JOG state
 FAST STOP button takes you from any state to FSTOP state
 (this can then look for a transition to ZERO SPEED before returning you to the STOP state)

It's that simple! No more sweating over relay interlocks, contact races, etc!

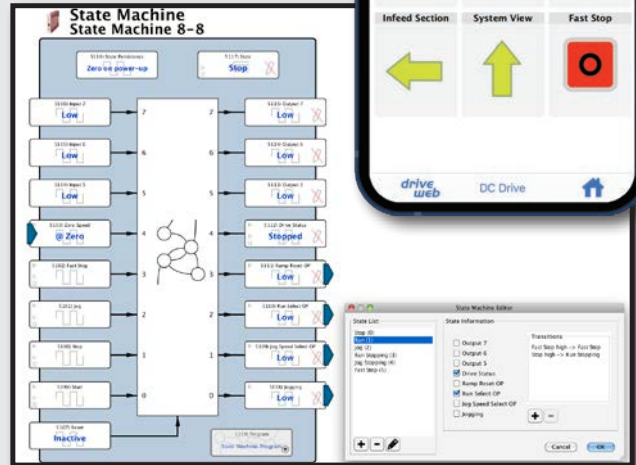
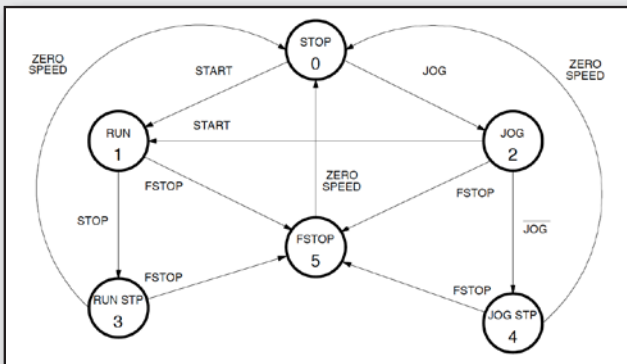

So obvious! So smart! So easy!

drive.web smart ideas

WiFi Roaming Interface

There are many inexpensive third party WiFi routers that when plugged into a **drive.web** Ethernet network provide secure, robust, roaming system access in an industrial environment using iOS or Android smart devices.



Enterprise Integration



The powerful system wide access inherent in the **drive.web** technology provides a great backbone on which to build integrated solutions in your entire global enterprise without additional complex data processing requirements. Multilevel password protection enables safe access for offsite accountants, production controllers and corporate management.



Online Training & System Support

The IP addressing capability in every **drive.web** device ensures easy support for field service and live online training for machine operators, system designers and plant maintenance engineers. If an internet connection is available near your machine or process it takes less than 1 minute to set up a live connection to our engineers or any other off site location. **drive.web** provides system wide access from any single location on your LAN - very smart, very easy!



drive.web smart technology ... Designed and built in the USA to International Standards: UL, cUL, CE, FCC, UK CA

AC drives



P2 Series Closed Loop Vector

High performance coordinated drive for:
Process automation
Converting
Printing
Machine tools

Up to 100 HP at 230 volts
Up to 400 HP at 460 volts
Up to 150 HP at 600 volts

IP20 package up to 400 HP - 50°C *
Optional NEMA 4X (IP66) to 30HP - 40°C *
NEMA 12 (IP55) 15 to 400 HP - 40°C *
* Approvals: UL, cUL, EAC, RCM

Closed loop speed better than 0.1%
150% overload, 60 secs (200%, 4 secs)
Up to 200% torque at zero speed
AC Induction, PM & Sync Rel motor modes
Built in brake transistor
EMC filter
Quiet - with switching up to 32KHz
Bright TFT display
DC Bus sharing
Safe Torque Off function
(IEC61508 SIL 2 & IEC62062 SIL 2)
ModbusRTU, CANopen
Plug-in control terminals

Options

drive.web programmable control
Extended I/O and USB
EIP, ModbusTCP, ProfibusDP, DeviceNet
Remote keypad with TFT display
savvyPanel touch screen HMI



V3 Series - Energy Efficient Drives For Fans & Pumps

Variable torque, fan & pump drive for:
HVAC
Water treatment
Building systems
Climate control
Flow control
Swimming pool control

Up to 100 HP at 230 volts
Up to 400 HP at 460 volts
Up to 175 HP at 600 volts

IP20 package up to 400 HP - 50°C *
NEMA 4X (IP66) to 30HP - 40°C (indoor) *
NEMA 12 (IP55) 15 to 400HP - 40°C *
* Approvals: UL, cUL, EAC, RCM

Low input harmonic current distortion
Compliant with EN61000-3-12
>98% drive efficiency
Low audible motor noise
Internal EMC filter
Smart energy optimization
Resonance avoidance
Sleep/wake functions
Intelligent maintenance intervals
110% overload, 60 secs
Motor flux braking
Quiet - with switching up to 32KHz
Power loss ride through
ModbusRTU, BACnet
Bright TFT display
Safe Torque Off function
(IEC61508 SIL 2 & IEC62062 SIL 2)

Motor options: Standard Induction - PM AC - Brushless DC - Synchronous Reluctance

Pump Features

Pump blockage detect/clear/stir
Pump preheat anti-condensation mode
Pump cascade control
Dry run protection

Options

drive.web programmable control
Extended I/O and USB
EIP, ModbusTCP, ProfibusDP, DeviceNet
Remote keypad with TFT display
Power disconnect
savvyPanel touch screen HMI

Fan Features

Drive fault auto bypass
Sleep mode with auto-boost
Fire override mode

drive.web distributed Ethernet control
Internet accessibility
Ethernet peer-to-peer networking
USB programming port
IIoT ready



TOUGH DRIVES FOR INDUSTRY



E3 Series General Purpose VFD

Constant torque, heavy duty drive for:
 General purpose machine control
 Pumps and blowers
 Conveyors
 Mixers

To 1.5 HP at 110V in, 230V 3Ø out
 To 25 HP at 230 volts
 To 50 HP at 460 volts

Sensorless vector control for:
 High starting torque & accurate speed
 Motors: Induction, PM, BLDC, SynRM

Standard IP20 - 50°C
Optional NEMA 4X (IP66) to 30 HP, 40°C
Approvals: UL, cUL, CE, RCM

Industrial, Pump & Fan control modes
 150% overload, 60 secs (175%, 2 secs)
 Spinstart into rotating motor
 Built in brake transistor (sizes 2, 3 & 4)
 Motor flux braking
 Adjustable skip frequency
 Quiet - with switching up to 32KHz
 Power loss ride through
 ModbusRTU port
 Configurable I/O
 Simple programming
 On board help card
 DIN rail and foot mount (IP20) (size 1 & 2)
 NEMA 4X

Options

drive.web programmable control
 Extended I/O
 EIP, ModbusTCP, ProfibusDP, DeviceNet
 Remote keypad with TFT display
savvyPanel touch screen HMI



NEMA 4X - IP66 Series For Harsh Environments

P2 Series Open/Closed Loop Vector Drives
E3 Series General Purpose VFDs
V3 Series Energy Efficient Drives
 Food processing
 Agricultural, water treatment
 Mining, cement, petrochemical

To 1.5 HP at 110V in, 230V 3Ø out (E3)
 To 15 HP at 230 volts (E3, P2)
 To 30 HP at 460 volts (E3, P2)

NEMA 4X (IP66) - 40°C
(outdoor rated)
Approvals: V3 - UL, cUL, EAC, RCM
P2 - UL, cUL, EAC, RCM
E3 - UL, cUL, CE, RCM

Open & closed loop vector or V/Hz
 Washdown, dust tight
 Chemical resistant ABS enclosure
 Corrosion protected heat sink
 Spinstart into rotating motor
 Built in brake transistor (sizes 2 & 3)
 Motor flux braking
 Adjustable skip frequency
 Quiet - with switching up to 32KHz
 Power loss ride through
 ModbusRTU port
 Compact packaging

Options

drive.web programmable control
 Power isolator switch, speed pot, F/R switch
 EIP, ModbusTCP, ProfibusDP, DeviceNet
 Remote keypad with TFT display
savvyPanel touch screen HMI



E3 Single Phase VFD For SP & PSC motors

Variable torque, fan & pump drive for:
 Fans & blowers
 Centrifugal pumps
 Fume extractors
 Air flow control

To 0.75 HP at 110 volts
 To 1.5 HP at 230 volts

Standard IP20 - 50°C
Optional NEMA 4X (IP66) - 40°C
(outdoor rated)

Approvals: UL, CE, RCM

For motor types:
 Shaded Pole (SP)
 Permanent Split Capacitor (PSC)
 Built in brake transistor (size 2)
 Motor flux braking
 Adjustable skip frequency
 Quiet - with switching up to 32KHz
 Power loss ride through
 ModbusRTU port
 Innovative smart boost start
 Simple programming
 DIN rail and foot mount (IP20)

Options

drive.web programmable control
 Extended I/O
 EIP, ModbusTCP, ProfibusDP, DeviceNet
 Remote keypad with TFT display
savvyPanel touch screen HMI



P2 Series

SYSTEMS VECTOR DRIVES

- High performance
- Induction, PM & Sync Rel Motor Control
- 230, 460, 600 volts models
- IP20 units up to 400HP
- NEMA12 units 15 - 400HP
- NEMA 4X up to 30HP

1 TO 400HP

FEATURES

Multiple Modes:

- Closed Loop Vector for high performance
- Open loop PM Motor Control
- Sensorless vector & V/Hz control

Up to 200% torque at zero speed

Sensorless speed regulation better than 1%

Torque control

DC bus sharing

Safe Torque Off function

Output to 500Hz (V/F Mode), 100Hz (Vector Mode)

Built-in 100% rated DB transistor up to 400HP

Integral PI controller

drive.web savvy function block programming

Silent running with up to 32KHz switching

200% starting torque

Bipolar 12 bit analog input (isolated +/-10V or 4-20mA)

ModbusRTU, RS485 port

CANopen port

EMC Filters

Bright TFT Display

DC chokes in frame sizes 5 to 8

Single phase input up to 200HP

Power loss ride through

Process control options

Programmable I/O

Hours run log & trip log

Cartridge fans for easy maintenance (NEMA12 drives)

Options:

Encoder feedback

Additional basic & **smarty** I/O options

EIP, Modbus TCP/IP, Profibus, DeviceNet, BACnet

Memory stick with bluetooth interface

Remote keypad with bright TFT display

2Khz output in V/Hz mode

Through panel mount for NEMA 12 versions



Smart drives for high performance coordinated drive systems and precision machine control

- Printing presses
- Extrusion & coating lines
- Automated assembly
- Indexing & registration
- Winders & web tension
- Material handling
- Cranes & hoists
- Textiles & fibres
- Metals industry
- Paper & cement mills
- Mining

NEMA 4X washdown models - see page 44



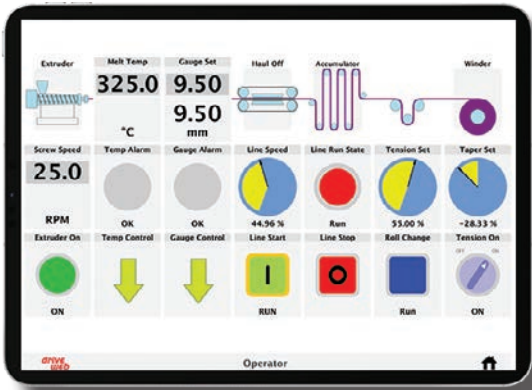

P2 very smart drives

The **drive.web** automation technology uses distributed control over Ethernet to provide cost effective systems integration for systems of any size or complexity.

savvyPanel touch

Easy, high resolution, NEMA4, touch screen operator stations.

Also run **savvyPanel** on PCs, Android or iOS devices



drive.web smart automation

- powerful programmable control functions
- peer-to-peer over Ethernet
- smart iPad/Android or touch screen PC operation
- Easy system wide Internet access



P2 Specifications

Input Ratings	Supply Voltage	200 - 240 ± 10% 380 - 480 ± 10% 500-600V ± 10%
	Supply Frequency	48 - 62 Hz
	Displacement PF	> 0.98
	Phase Imbalance	3% Maximum allowed
	Inrush Current	< Rated current
	Power Cycles	120 per hour max, evenly spaced
Output Ratings	Power Output	230V, 1-ph in: 1-10 HP (0.75-7.5 kW) 230V, 3-ph in: 1-100 HP (0.75-75 kW) 400V, 3-ph in: 1-400 HP (0.75-250kW) 460V, 3-ph in: 1-400 HP (0.75-250kW)
	Overload Capacity	150% for 60 secs, 200% for 4 secs.
	Output Frequency	0-500Hz in V/Hz mode (0.1 Hz res) (optional 2KHz) 0-100Hz in vector made
Ambient Ratings	Temperature	Storage: -40°C to 60°C Operating: -10°C to 40°C (IP55 & IP66) -10°C to 50°C (IP20)
	Altitude	Up to 1000m ASL without de-rating Up to 2000m Max UL Approved Up to 4000m Max (non UL) Above 1000m, de-rate 1% per 100m
	Humidity	95% non-condensing
Enclosures	Ingress Protection	IP20 - Frame sizes 2 - 6, & 8 IP55 (NEMA 12) - Frame sizes 4 - 8 IP66 (NEMA 4X) - Optional sizes 2 - 4
Programming	Keypad	Standard: built in keypad Optional: Remote keypad Optistick memory stick drive.web savvy software
	Display	Multi-language TFT Display (sizes 2 - 8)
Control	Control Modes	Closed Loop (encoder) speed control Closed Loop (encoder) torque control Open Loop PM vector control Sensorless vector speed control V/F Voltage vector Energy optimized V/F
	Modulation	4 - 32 kHz effective
	Stop Mode	Ramp to stop - adjustable 0.1-600 secs Safe Torque Off mode
	Braking	Motor flux braking (DC injection) Built in brake transistor
	Skip Frequency	Single point user adjustable
	Analog Setpoint Control	0-10v, 10-0v, ±10v 0-20mA, 20-0mA, 4-20mA, 20-4mA
	Preset Speeds	Up to 8
	Digital Setpoint Control	Keypad ModbusRTU CANopen
	Automation	Optional drive.web Ethernet distributed control + programmable control, extra I/O, operator stations
	Communications Options	drive.web , ModbusTCP, EIP, DeviceNet, Profibus
I/O Specification	Power Supply	24VDC, 100mA short protected 10VDC, 5mA for setpoint potentiometer
	Programmable Inputs	3 x Digital 10 to 30 VDC, response <4ms 2 x Analog/digital
	Programmable outputs	2 x Analog, 0-10V, 0-20mA, 4-20mA 2 x Relay NO, 6A @ 250VAC, 5A @ 30VDC
Control & Monitoring	PID	Internal PID with feedback display
	Fault Memory	Last 4 trips stored with time stamp
	Data Logging	Current, temperature, DC Bus volts prior to trip
	Maintenance Indicator	Service life monitor with user adjustable interval
	Monitoring	Hours run Resettable and non-resettable kWh meters

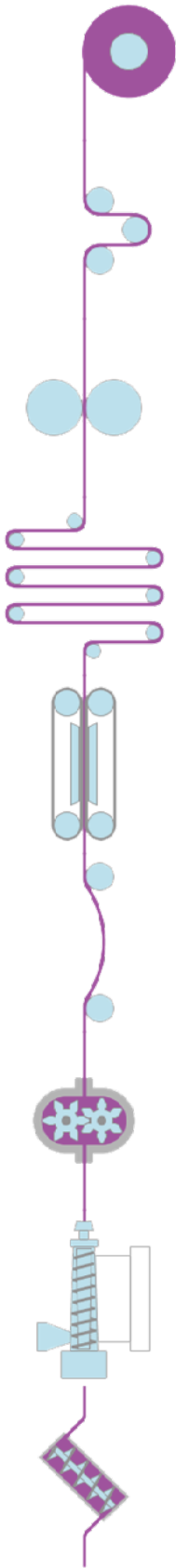

P2 Series Models & Ratings

Standard IP20 Packages

With EMC Filter & DB transistor

200-240V ± 10%, 1-ph in, 230V, 3-ph motor

Model	HP	Amps	Size
P2-22010-1HF42-T	1	4.3	2
P2-22020-1HF42-T	2	7	2
P2-22030-1HF42-T	3	10.5	2

200-240V ± 10%, 3-ph in, 230V, 3-ph motor

Model	HP	Amps	Size
P2-22010-3HF42-T	1	4.3	2
P2-22020-3HF42-T	2	7	2
P2-22030-3HF42-T	3	10.5	2
P2-32050-3HF42-T	5	18	3
P2-32075-3HF42-T	7.5	24	3

380-480V ± 10%, 3-ph in, 460V, 3-ph motor

Model	HP	Amps	Size
P2-24010-3HF42-T	1	2.2	2
P2-24020-3HF42-T	2	4.1	2
P2-24030-3HF42-T	3	5.8	2
P2-24050-3HF42-T	5	9.5	2
P2-34075-3HF42-T	7.5	14	3
P2-34100-3HF42-T	10	18	3
P2-34150-3HF42-T	15	24	3

NEMA12 (IP55) Packages

With EMC Filter, DB transistor

200-240V ± 10%, 3-ph in, 230V, 3-ph motor

Model	HP	Amps	Size
P2-42075-3HF4N-T ‡	7.5	24	4
P2-42100-3HF4N-T ‡	10	30	4
P2-42150-3HF4N-T ‡	15	46	4
P2-52020-3HF4N-T ‡	20	61	5
P2-52025-3HF4N-T ‡	25	72	5
P2-62030-3HF4N-T ‡	30	90	6
P2-62040-3HF4N-T ‡	40	110	6
P2-62050-3HF4N-T ‡	50	150	6
P2-62060-3HF4N-T ‡	60	180	6
P2-72075-3HF4N-T	75	202	7
P2-72100-3HF4N-T	100	248	7

380-480V ± 10%, 3-ph in, 460V, 3-ph motor

Model	HP	Amps	Size
P2-44150-3HF4N-T ‡	15	24	4
P2-44200-3HF4N-T ‡	20	30	4
P2-44250-3HF4N-T ‡	25	39	4
P2-44300-3HF4N-T ‡	30	46	4
P2-54040-3HF4N-T ‡	40	61	5
P2-54050-3HF4N-T ‡	50	72	5
P2-64060-3HF4N-T ‡	60	90	6
P2-64075-3HF4N-T ‡	75	110	6
P2-64120-3HF4N-T ‡	120	150	6
P2-64150-3HF4N-T ‡	150	180	6
P2-74175-3HF4N-T	175	202	7
P2-74200-3HF4N-T	200	240	7
P2-74250-3HF4N-T	250	302	7
P2-84300-3HF4N-T ‡	300	370	8
P2-84400-3HF4N-T ‡	400	480	8

For single phase supply derate to 50%

P2 Series 600 Volts Drives

600VAC DRIVES

Standard IP20 Packages to 20 HP

500-600V ± 10%, 3-ph in, 500-600V, 3-ph motor

Model	HP	Amps	Size
P2-26010-3H042-T	1	2.1	2
P2-26020-3H042-T	2	3.1	2
P2-26030-3H042-T	3	4.1	2
P2-26050-3H042-T	5	6.5	2
P2-26075-3H042-T	7.5	9	2
P2-36100-3H042-T	10	12	3
P2-36150-3H042-T	15	17	3
P2-36200-3H042-T	20	22	3

NEMA12 (IP55) Packages to 250 HP

500-600V ± 10%, 3-ph in, 500-600V, 3-ph motor

Model	HP	Amps	Size
P2-46200-3H04N-T ‡	20	22	4
P2-46250-3H04N-T ‡	25	28	4
P2-46300-3H04N-T ‡	30	34	4
P2-46400-3H04N-T ‡	40	43	4
P2-56050-3H04N-T ‡	50	54	5
P2-56060-3H04N-T ‡	60	65	5
P2-66075-3H04N-T ‡	75	78	6
P2-66100-3H04N-T ‡	100	105	6
P2-66125-3H04N-T ‡	125	130	6
P2-66150-3H04N-T ‡	150	150	6

P2 OPTIONS

T2-ENCOD-IN	Encoder feedback module
T2-OPORT-IN	Remote keypad & display
T3-OPPAD-IN	Remote keypad w/TFT display



Dimensions

Size	2	3	4	5	6	7	8
Height (ins)	8.7"	10.3"	17.3"	21.3"	34.1"	50.4"	52.5"
Height (mm)	221	261	440	540	865	1280	1334
Width (ins)	4.4"	5.2"	6.8"	9.3"	13.0"	13.0"	17.5"
Width (mm)	112	131	173	235	330	330	444
Depth (ins)	7.3"	8.1"	9.1"	10.6"	13.4"	14.6"	16.7"
Depth (mm)	185	205	230	270	340	370	423
Weight (LBS)	4	7.7	25.4	49.6	111	177	440
Weight (KG)	1.8	3.5	11.5	22.5	50	80	200

Note:
Drives marked ‡ are also available in IP20 form. Please call for details, pricing, and availability.

V3 ECO DRIVES

Energy Efficient Drives

Variable torque, fan & pump drive for:

HVAC

Building systems

Climate control

Flow control

Up to 400HP at 460 Volts

IP20 up to 400HP - 50°C

NEMA12 (IP55) 10 to 400HP - 40°C *

NEMA4X (IP66) to 30HP - 40°C (indoor) *

- Low input harmonic current distortion
- Compliant with EN61000-3-12
- >98% drive efficiency
- Low audible motor noise
- Clear, TFT, multi-language display
- Internal EMC filter
- Smart energy optimization
- Smart pump & fan functions
- Resonance avoidance
- Sleep/wake functions
- Intelligent maintenance intervals
- 110% overload, 60 secs
- Motor flux braking
- ModbusRTU, BACnet
- Energy optimization for max efficiency
- DC bus chokes in frames 5 - 8

Options

drive.web savvy smart programmable automation

Easy off site Internet access to complete systems

Ethernet peer-to-peer networking

Extended I/O

EIP, ModbusTCP, ProfibusDP, DeviceNet

Remote keypad with bright TFT display

Power disconnect, sizes 2 & 3

savvyPanel touch screen HMI



Motor compatibility:

- Induction motors
- PM AC motors
- Brushless DC motors
- Synchronous reluctance

V3 ECO DRIVE

With Smart Energy Optimization

Typically saves 2 to 4% energy over standard VFDs

Every 1% saves 1100 kWh per year for 50HP running 60 hours a week, 50 weeks a year!



V3 ECO PUMP & FAN



VARIABLE TORQUE FAN & PUMP DRIVES



UP TO 400 HP

- Fan & pump features
- IP20 units to 400 HP
- NEMA 4X (IP66) units to 30 HP
- NEMA 12 (IP55) units to 400 HP
- BACnet & ModbusRTU

FEATURES

Dedicated HVAC and centrifugal pump controller
 Built in EMC filter standard
 DC bus chokes built in, sizes 6 - 7
 Multi-language, plain text TFT display for ease of use
 Energy optimization for maximum efficiency
 BACnet and ModbusRTU as standard
 Built-in hours run and kWh meters
 Built-in PID controller
 Advanced application functions for easy programming
 High frequency switching (up to 32kHz) for quiet running
 Built-in motor flux braking
 Programmable I/O
 Power loss ride through
 40°C ambient
 HVAC functions:
 Bi-directional Fire Mode for emergency ventilation
 Drive fault bypass select
 Sleep mode with auto boost
 Pump functions:
 Blockage detection/clear/stir
 Adjustable cleaning cycle
 Multi-pump cascade control
 Dry run protection
 Pump pre-heat anti condensation mode
 Standards - UL, cUL, EAC and RCM

Options:

drive.web savvy smart programmable automation
savvyPanel graphical, touch screen operator technology
 Easy, off site Internet access to the complete system
 Ethernet peer to peer networking
 Remote keypad with bright TFT display
 Ethernet ModbusTCP and EIP
 3 additional relay outputs for cascade control
 Additional *smarty* I/O option
 Built in power isolator switch sizes 2 & 3

Specifications

Input Ratings	Supply Voltage	200 - 240 ± 10% 380 - 480 ± 10% 500 - 600 ± 10%
	Supply Frequency	48 - 62 Hz
	Displacement PF	> 0.98
	Phase Imbalance	3% Maximum allowed
	Inrush Current	< Rated current
	Power Cycles	120 per hour max, evenly spaced
Output Ratings	Power Output	230V, 1-ph in: 1-10 HP (0.75-7.5 kW) 230V, 3-ph in: 1-100 HP (0.75-75 kW) 460V, 3-ph in: 1-400 HP (0.75-250kW) 575V, 3-ph in: 1-175 HP (0.75-110kW)
	Overload Capacity	110% for 60 secs, 165% for 4 secs.
	Output Frequency	0-250Hz, 0.1 Hz resolution
Ambient Ratings	Temperature	Storage: -40°C to 60°C Operating: -10°C to 40°C
	Altitude	Up to 1000m ASL without de-rating Up to 2000m Max UL Approved Up to 4000m Max (non UL) Above 1000m, de-rate 1% per 100m
	Humidity	95% non-condensing
Enclosures	Ingress Protection	NEMA4X sizes 2 - 4; NEMA12 sizes 4 - 8
Programming	Keypad	Standard: built in keypad Optional: Remote keypad <i>drive.web savvy</i> software
	Display	Multi-Language TFT Display
Control	Control Modes	ECO sensorless vector for: motor options: Standard Induction, PMAC, BLDC, Sync Rel
	Modulation	4 - 32 kHz effective
	Stop Mode	Ramp to stop - adjustable 0.1-600 secs Coast to stop
	Braking	Motor flux braking (DC injection)
	Skip Frequency	Single point user adjustable
	Analog Setpoint Control	0-10V, 10-0V, ±10V 0-20mA, 20-0mA, 4-20mA, 20-4mA
	Digital Setpoint Control	Keypad ModbusRTU BACnet
	Automation	Optional <i>drive.web</i> Ethernet distributed control + programmable control, extra I/O, operator stations
Communications Options	<i>drive.web</i> , ModbusTCP, EIP, DeviceNet, Profibus	
I/O Specification	Power Supply	24VDC, 100mA short protected 10VDC, 10mA for setpoint potentiometer
	Programmable Inputs	3 x Digital 8 to 30 VDC, response <4ms 2 x Analog / digital
	Programmable outputs	2 x Analog, 0-10V, 0-20mA, 4-20mA 2 x Relay NO, 6A @ 250VAC, 5A @ 30VDC
Control & Monitoring	PID	Internal PID with feedback display
	Fault Memory	Last 4 trips stored with time stamp
	Data Logging	Current, temperature, DC Bus volts prior to trip
	Maintenance Indicator	Service life monitor with user adjustable interval
	Monitoring	Drive hours run & cooling fan run time Resettable and non-resettable kWh meters
Application functions	HVAC Functions	Fire mode for emergency ventilation
	Pump functions	Pump blockage detection Pump cleaning cycles Multi-pump cascade control Pump stir mode

The harder they work, the more you save!

200-240V ± 10%, 1-ph in, 230V, 3-ph motor

Model	HP	Amps	Size	NEMA
size 2 - IP20, TFT display & EMC Filter:				
V3-220043-1F12-T	1	4.3	2	IP20
V3-220070-1F12-T	2	7	2	IP20
V3-220105-1F12-T	3	10.5	2	IP20
size 2 - NEMA 4X, TFT display & EMC Filter:				
V3-220043-1F1#-T	1	4.3	2	4X
V3-220070-1F1#-T	2	7	2	4X
V3-220105-1F1#-T	3	10.5	2	4X

200-240V ± 10%, 3-ph in, 230V, 3-ph motor

Model	HP	Amps	Size	NEMA
sizes 2 & 3 - IP20, TFT display & EMC Filter:				
V3-220043-3F12-T	1	4.3	2	IP20
V3-220070-3F12-T	2	7	2	IP20
V3-220105-3F12-T	3	10.5	2	IP20
V3-320180-3F12-T	5	18	3	IP20
V3-320240-3F12-T	7.5	24	3	IP20
sizes 2 & 3 - NEMA 4X, TFT display & EMC Filter:				
V3-220043-3F1#-T	1	4.3	2	4X
V3-220070-3F1#-T	2	7	2	4X
V3-220105-3F1#-T	3	10.5	2	4X
V3-320180-3F1#-T	5	18	3	4X
V3-320240-3F1#-T	7.5	24	3	4X
sizes 4-7 - NEMA 12, TFT display, EMC filter:				
V3-420300-3F1N-T ‡	10	30	4	12
V3-420460-3F1N-T ‡	15	46	4	12
V3-520610-3F1N-T ‡	20	61	5	12
V3-520720-3F1N-T ‡	25	72	5	12
V3-520900-3F1N-T ‡	30	90	5	12
V3-621100-3F1N-T ‡	40	110	6	12
V3-621500-3F1N-T ‡	50	150	6	12
V3-621800-3F1N-T ‡	60	180	6	12
V3-722020-3F1N-T	75	202	7	12
V3-722480-3F1N-T	100	248	7	12

380-480V ± 10%, 3-ph in, 460V, 3-ph motor

Model	HP	Amps	Size	NEMA
sizes 2 & 3 - IP20, TFT display & EMC Filter:				
V3-240022-3F12-T	1	2.2	2	IP20
V3-240041-3F12-T	2	4.1	2	IP20
V3-240058-3F12-T	3	5.8	2	IP20
V3-240095-3F12-T	5	9.5	2	IP20
V3-340140-3F12-T	7.5	14	3	IP20
V3-340180-3F12-T	10	18	3	IP20
V3-340240-3F12-T	15	24	3	IP20
sizes 2 & 3 - NEMA 4X, TFT display & EMC Filter:				
V3-240022-3F1#-T	1	2.2	2	4X
V3-240041-3F1#-T	2	4.1	2	4X
V3-240058-3F1#-T	3	5.8	2	4X
V3-240095-3F1#-T	5	9.5	2	4X
V3-240140-3F1#-T	7.5	14	2	4X
V3-340180-3F1#-T	10	18	3	4X
V3-340240-3F1#-T	15	24	3	4X
sizes 4-7 - NEMA 12, TFT display & EMC filter:				
V3-440300-3F1N-T ‡	20	30	4	12
V3-440390-3F1N-T ‡	25	39	4	12
V3-440460-3F1N-T ‡	30	46	4	12
V3-540610-3F1N-T ‡	40	61	5	12
V3-540720-3F1N-T ‡	50	72	5	12
V3-540900-3F1N-T ‡	60	90	5	12
V3-641100-3F1N-T ‡	75	110	6	12
V3-641500-3F1N-T ‡	120	150	6	12
V3-641800-3F1N-T ‡	150	180	6	12
V3-642020-3F1N-T ‡	175	202	6	12
V3-742400-3F1N-T	200	240	7	12
V3-743020-3F1N-T	250	302	7	12
V3-843700-3F1N-T ‡	300	370	8	12
V3-844800-3F1N-T ‡	400	480	8	12



speedy on board
Ethernet networking
USB programming
smart automation

**Size 2 & 3 drives
= A or E**

A = no disconnect switch
E = with power disconnect switch

**ECO
Efficient
Economical
Smart
Solutions**



Note:
Drives marked ‡ are also available in IP20 form. Please call for details, pricing, and availability.

Dimensions & Weights

Size	2	3	4	5	6	7	8
IP20 Drives							
Height (ins)	8.7"	10.3"	16.6"	19.1"			38.3"
Height (mm)	221	261	418	486			974
Width (ins)	4.4"	5.2"	6.7"	9.2"			17.5"
Width (mm)	110	131	233	233			444
Depth (ins)	7.3"	8.1"	10.2"	10.2"			16.6"
Depth (mm)	185	205	260	260			423
Weight LB/KG	4/1	7/3	20/9	40/18			274/125
NEMA 4X (IP66) Drives							
Height (ins)	10.1"	12.2"	14.2"				
Height (mm)	257	310	360				
Width (ins)	7.4"	8.3"	9.5"				
Width (mm)	188	211	240				
Depth (ins)	7.2"	9.3"	10.7"				
Depth (mm)	182	235	271				
Weight LB/KG	7.7/3.5	14.6/6.6	21/9.5				
NEMA 12 (IP55) Drives							
Height (ins)	17.8"	21.3"	34.1"	50.4"	52.5"		
Height (mm)	450	540	865	1280	1334		
Width (ins)	6.7"	9.3"	13.0"	13.0"	17.5		
Width (mm)	171	235	330	330	444		
Depth (ins)	9.9"	10.6"	13.1"	14.2"	16.6		
Depth (mm)	252	270	332	360	423		
Weight LB/KG	25/12	51/23	121/55	196/89	317/144		

600 Volts Drives

**500-600V ± 10%, 3-ph in
500-600V, 3-ph motor**

Model	HP	Amps	Size	NEMA
IP20 with TFT display				
V3-260021-3012-T	1	2.1	2	IP20
V3-260031-3012-T	2	3.1	2	IP20
V3-260041-3012-T	3	4.1	2	IP20
V3-260065-3012-T	5	6.5	2	IP20
V3-260090-3012-T	7.5	9	2	IP20
V3-360120-3012-T	10	12	3	IP20
V3-360170-3012-T	15	17	3	IP20
V3-360220-3012-T	20	22	3	IP20

NEMA 4X (IP66), with TFT text display

Model	HP	Amps	Size	NEMA
Unswitched				
V3-260021-301A-T	1	2.1	2	4X
V3-260031-301A-T	2	3.1	2	4X
V3-260041-301A-T	3	4.1	2	4X
V3-260065-301A-T	5	6.5	2	4X
V3-260090-301A-T	7.5	9	2	4X
V3-360120-301A-T	10	12	3	4X
V3-360170-301A-T	15	17	3	4X
w/Disconnect				
V3-260021-301E-T	1	2.1	2	4X
V3-260031-301E-T	2	3.1	2	4X
V3-260041-301E-T	3	4.1	2	4X
V3-260065-301E-T	5	6.5	2	4X
V3-260090-301E-T	7.5	9	2	4X
V3-360120-301E-T	10	12	3	4X
V3-360170-301E-T	15	17	3	4X

NEMA 12 (IP55) with TFT text display

Model	HP	Amps	Size	NEMA
V3-460220-301N-T ‡	20	22	4	12
V3-460280-301N-T ‡	25	28	4	12
V3-460340-301N-T ‡	30	34	4	12
V3-460430-301N-T ‡	40	43	4	12
V3-560540-301N-T ‡	50	54	5	12
V3-560650-301N-T ‡	60	65	5	12
V3-660780-301N-T ‡	75	78	6	12
V3-661050-301N-T ‡	100	105	6	12
V3-661300-301N-T ‡	125	130	6	12
V3-661500-301N-T ‡	150	150	6	12

E3 Sensorless Vector

General purpose drives with all purpose features

Up to 50 HP

Basic IP20 or NEMA 4X (IP66)

Basic control or full featured systems drive

3-Phase & single phase motor versions

Basic or loaded, the new E3 is designed to give the best in value, performance and ease of use.

Sensorless vector control for:

- High efficiency operation
- Selectable motor types
Standard Induction, AC PM, BLDC, Sync Reluctance
- 3 selectable operating modes:
Industrial, Fan, & Pump



Expandable
Economical
Easy
Enduring
Efficient



speedy dw278
Programmable control & Ethernet networking



T3-STICK
Plug-in upload/download configuration memory stick



T3-OPPAD
Remote keypad & TFT display



savvyPanel touch
7" touch screen
Auto-connects to all drives & devices on your LAN



KEY FEATURES

- Compact packaging
- Simple mechanical and electrical installation
- 50°C ambient rating (IP20), 40°C ambient rating (NEMA 4X)
- 150% rating for 60 seconds, 175% for 2 seconds
- Simple 14 parameter basic set up
- Integral brake transistor, sizes 2, 3, 4, and 5 (100% continuous rated)
- ModbusRTU serial port

Options:

- Remote keypad and display
- T3-STICK plug in unit for fast up/down load of parameters
- smarty** remote I/O, programmable control & Ethernet networking
- speedy** programmable control & Ethernet networking
- savvyPanel** smart touch screen operator station technology
- Integral RFI filter option

For NEMA 4X versions, see Page 44



SPECIFICATION

Output	Frequency	0 to 500Hz. (Please call for special builds up to 2000Hz)
Supply options	Frequency	48 - 62 Hz
	Voltage/Phases	100 - 132 volts max, single phase (0.5 - 1.5HP)
		180 - 264 volts max, 1-phase (0.5 - 10HP)
Environment	Temperature	180 - 264 volts max, 3-phase (0.5 - 25HP)
		342 - 528 volts max, 3-phase (0.5 - 50HP)
		IP20: Operating, -10 to 50°C max Storage, -40 to 60°C
Control	Altitude	NEMA 4X: Operating, -10 to 40°C max Storage, -40 to 60°C
	Humidity	0-2000M, derate 1% per 100M above 1000M
	Ingress Protection	up to 95%, non condensing
	Mode	Basic IP20, Optional IP66 (NEMA 4X outdoor rated)
	PWM frequency	Voltage vector
	V/Hz ratio	4 to 32KHz (effective)
	Boost	Linear
	Stop modes	Yes
	Skip frequency	Coast / ramp / DC brake
	Setpoint reference	One point, adjustable frequency band
Configurable I/O	Preset speeds	0-10VDC, 4-20mA, 20-4mA, 0-20mA, Keypad, Modbus
	PI control	4
	Spin start	Direct & analog input trim
	Accel/Decel	Starts safely into rotating motor
	Input 2	0 - 600 seconds + Ramp stop decel 0 - 600 seconds
	Input 3	Input 1 Programmable digital input
	Input 4	Programmable digital input
	Output 1	Configurable analog or digital input
	Output 2	Configurable analog or digital input
	Output 2	Configurable analog or digital output
Protection	Drive trip	Normally open relay contact 30VDC 5A, 250VAC 6A
	Motor	Over/under volts, over current, external trip,
	Trip memory	Overload, over temperature, short circuit, ground fault
		Last 4 trips stored

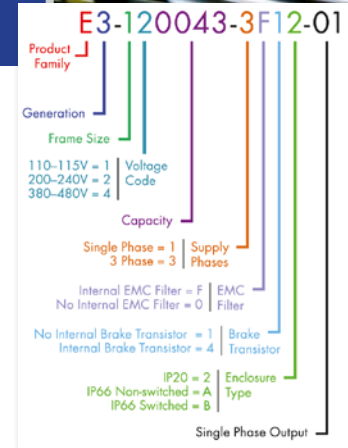

Cost effective either stand alone or networked in coordinated systems

Standard IP20 Protected

Ambient Rating 50°C except where marked
* Ambient Rating 45°C

IP20



Size	1		2		3		4		5	
	in	mm	in	mm	in	mm	in	mm	in	mm
High	6.8	173	8.7	221	10.3	261	16.5	420	19.1	486
Wide	3.3	83	4.3	110	5.2	131	6.7	171	8.7	222
Deep	4.8	123	5.9	150	6.9	175	8.4	212	8.9	226
Weight	lbs	kg	lbs	kg	lbs	kg	lbs	kg	lbs	kg
	2.2	1.0	3.75	1.7	7.0	3.2	20.0	9.1	39.9	18.1

STANDARD IP20 DRIVES

Model	Supply	Motor	Power	Amps	Size
E3-110023-1012	1Ø, 115V	3Ø, 230V	0.5HP	2.3	1
E3-110043-1012	1Ø, 115V	3Ø, 230V	1.0HP	4.3	1
E3-210058-1042	1Ø, 115V	3Ø, 230V	1.5HP	5.8	2
E3-120023-1012	1Ø, 230V	3Ø, 230V	0.5HP	2.3	1
E3-120043-1012	1Ø, 230V	3Ø, 230V	1HP	4.3	1
E3-120070-1012	1Ø, 230V	3Ø, 230V	2HP	7	1
E3-220070-1042	1Ø, 230V	3Ø, 230V	2HP	7	2
E3-220105-1042	1Ø, 230V	3Ø, 230V	3HP	10.5	2
E3-320153-1042	1Ø, 230V	3Ø, 230V	5HP	15.3	3
E3-120023-3012	3Ø, 230V	3Ø, 230V	0.5HP	2.3	1
E3-120043-3012	3Ø, 230V	3Ø, 230V	1HP	4.3	1
E3-120070-3012	3Ø, 230V	3Ø, 230V	2HP	7	1
E3-220070-3042	3Ø, 230V	3Ø, 230V	2HP	7	2
E3-220105-3042	3Ø, 230V	3Ø, 230V	3HP	10.5	2
E3-320180-3042	3Ø, 230V	3Ø, 230V	5HP	18	3
E3-320240-3042	3Ø, 230V	3Ø, 230V	7.5HP	24	3
E3-420300-3042	3Ø, 230V	3Ø, 230V	10HP	30	4
E3-420460-3042	3Ø, 230V	3Ø, 230V	15HP	46	4
E3-520610-3F42	3Ø, 230V	3Ø, 230V	20HP	61	5
E3-520720-3F42	3Ø, 230V	3Ø, 230V	25HP	72	5
E3-140022-3012	3Ø, 460V	3Ø, 460V	1HP	2.2	1
E3-140041-3012	3Ø, 460V	3Ø, 460V	2HP	4.1	1
E3-240041-3042	3Ø, 460V	3Ø, 460V	2HP	4.1	2
E3-240058-3042	3Ø, 460V	3Ø, 460V	3HP	5.8	2
E3-240095-3042	3Ø, 460V	3Ø, 460V	5HP	9.5	2
E3-340140-3042	3Ø, 460V	3Ø, 460V	7.5HP	14	3
E3-340180-3042	3Ø, 460V	3Ø, 460V	10HP	18	3
E3-340240-3042	3Ø, 460V	3Ø, 460V	15HP	24	3
E3-440300-3042	3Ø, 460V	3Ø, 460V	20HP	30	4
E3-440390-3042	3Ø, 460V	3Ø, 460V	25HP	39	4
E3-440460-3042	3Ø, 460V	3Ø, 460V	30HP	46	4
E3-540610-3F42	3Ø, 460V	3Ø, 460V	40HP	61	5
E3-540720-3F42	3Ø, 460V	3Ø, 460V	50HP	72	5

Please call +410-604-3400 for availability

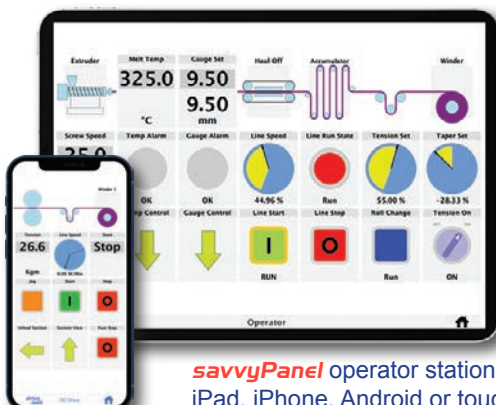

drive.web
smart automation

- powerful programmable control functions
- peer-to-peer over Ethernet
- smart iPad, Android or touch screen PC operation
- Internet access

savvyPanel operator station technology runs on iPad, iPhone, Android or touch screen PC

NEMA 4X (IP66) Enclosed Drives

For harsh, wet & dirty environments

Switched version with keypad, display, speed pot, forward/off/reverse switch & power isolator switch.

Unswitched version with keypad & display.

Key Features:

- 40°C ambient temperature
- Derate for operation > 40°C <= 50°C
- Conduit cable entry
- Padlockable power switch
- ModbusRTU port
- ABS moldings & corrosion resistant heat sink
- All standard drive features included
- Brake standard on sizes 2 & 3
- Optional internal Ethernet size 2 & 3



Embed a **speedy** in the drive to provide Ethernet networking & programmable control

NEMA 4X (IP66) OUTDOOR RATED E3 SERIES GENERAL PURPOSE VFD

*Outdoor Applications will require a Sun Shade (not included)

SIZE	HP	AMPS	UNSWITCHED	SWITCHED
115V, SINGLE PHASE IN, 230V, 3-PHASE MOTOR				
1	0.5	2.3	E3-110023-101A	E3-110023-101B
1	1.0	4.3	E3-110043-101A	E3-110043-101B
2	1.5	5.8	E3-210058-104A	E3-210058-104B
230V, SINGLE PHASE IN, 230V, 3-PHASE MOTOR				
1	0.5	2.3	E3-120023-101A	E3-120023-101B
1	1	4.3	E3-120043-101A	E3-120043-101B
1	2	7	E3-120070-101A	E3-120070-101B
2	2	7	E3-220070-104A	E3-220070-104B
2	3	10.5	E3-220105-104A	E3-220105-104B
3	5	15.3	E3-320153-104A	E3-320153-104B
230V, 3-PHASE IN, 230V, 3-PHASE MOTOR				
1	0.5	2.3	E3-120023-301A	E3-120023-301B
1	1	4.3	E3-120043-301A	E3-120043-301B
1	2	7	E3-120070-301A	E3-120070-301B
2	2	7	E3-220070-304A	E3-220070-304B
2	3	10.5	E3-220105-304A	E3-220105-304B
3	5	18	E3-320180-304A	E3-320180-304B
3	7.5	24	E3-320240-304A	E3-320240-304B
4	10	30	E3-420300-304A	E3-420300-304B
4	15	46	E3-420460-304A	E3-420460-304B
380/460V, 3-PHASE IN, 380/460V, 3-PHASE MOTOR				
1	1	2.2	E3-140022-301A	E3-140022-301B
1	2	4.1	E3-140041-301A	E3-140041-301B
2	2	4.1	E3-240041-304A	E3-240041-304B
2	3	5.8	E3-240058-304A	E3-240058-304B
2	5	9.5	E3-240095-304A	E3-240095-304B
3	7.5	14	E3-340140-304A	E3-340140-304B
3	10	18	E3-340180-304A	E3-340180-304B
3	15	24	E3-340240-304A	E3-340240-304B
4	20	30	E3-440300-304A	E3-440300-304B
4	25	39	E3-440390-304A	E3-440390-304B
4	30	46	E3-440460-304A	E3-440460-304B

Ethernet networking & basic programmable control option dw278

NEMA 4X (IP66) OUTDOOR RATED P2 OPEN/CLOSED LOOP VECTOR DRIVES

With EMC filter, brake transistor +/- DC bus

SIZE	HP	AMPS	UNSWITCHED	SWITCHED
230V, SINGLE PHASE IN, 230V, 3-PHASE MOTOR				
2	1	4.3	P2-22010-1HF4A	P2-22010-1HF4B
2	2	7	P2-22020-1HF4A	P2-22020-1HF4B
2	3	10.5	P2-22030-1HF4A	P2-22030-1HF4B
230V, 3-PHASE IN, 230V, 3-PHASE MOTOR				
2	1	4.3	P2-22010-3HF4A	P2-22010-3HF4B
2	2	7	P2-22020-3HF4A	P2-22020-3HF4B
2	3	10.5	P2-22030-3HF4A	P2-22030-3HF4B
3	5	18	P2-32050-3HF4A	P2-32050-3HF4B
380/460V, 3-PHASE IN, 380/460V, 3-PHASE MOTOR				
2	1	2.2	P2-24010-3HF4A	P2-24010-3HF4B
2	2	4.1	P2-24020-3HF4A	P2-24020-3HF4B
2	3	5.8	P2-24030-3HF4A	P2-24030-3HF4B
2	5	9.5	P2-24050-3HF4A	P2-24050-3HF4B
3	7.5	14	P2-34075-3HF4A	P2-34075-3HF4B
3	10	18	P2-34100-3HF4A	P2-34100-3HF4B
500/600V, 3-PHASE IN, 500/600V, 3-PHASE MOTOR				
2	1	2.1	P2-26010-3H04A	P2-26010-3H04B
2	2	3.1	P2-26020-3H04A	P2-26020-3H04B
2	3	4.1	P2-26030-3H04A	P2-26030-3H04B
2	5	6.5	P2-26050-3H04A	P2-26050-3H04B
2	7.5	9	P2-26075-3H04A	P2-26075-3H04B
3	10	12	P2-36100-3H04A	P2-36100-3H04B
3	15	17	P2-36150-3H04A	P2-36150-3H04B
4	25	28	P2-46250-3H04A	P2-46250-3H04B
4	30	34	P2-46300-3H04A	P2-46300-3H04B
4	40	43	P2-46400-3H04A	P2-46400-3H04B

P2 Series NEMA 4X - Dimensions and Weight

Size	Height	Width	Depth	Weight
2	10.1" (257mm)	7.4" (188mm)	6.8" (172mm)	7.7lbs (3.5kg)
3	12.2" (310mm)	8.3" (211mm)	9.3" (235mm)	14.6lbs (6.6kg)
4	14.2" (360mm)	9.5" (240mm)	10.7" (271mm)	21lbs (9.5kg)

E3 Series NEMA 4X - Dimensions and Weight

Size	Height	Width	Depth	Weight
1	9.1" (232mm)	6.4" (161mm)	6.4" (162mm)	5.1lbs (2.3kg)
2	10.1" (257mm)	7.4" (188mm)	7.2" (182mm)	7.7lbs (3.5kg)
3	12.2" (310mm)	8.3" (211mm)	9.3" (235mm)	14.6lbs (6.6kg)
4	14.2" (360mm)	9.5" (240mm)	10.7" (271mm)	21lbs (9.5kg)

AC Drive Options

ITEM	DESCRIPTION	MODEL		
		P2	V3	E3
Touch Screen Programmable Operator Stations				
dw230	savvyPanel touch , programmable NEMA 4 diplay	✓	✓	✓
dw260	savvyPanel touch , programmable NEMA 4 diplay	✓	✓	✓
Remote Keypads				
T2-OPORT-IN	Remote Keypad (with cable)	✓	✓	✓
T3-OPPAD-IN	Remote keypad with TFT display (with cable)	✓	✓	✓
Communications				
speedy dw22X-00	ModbusTCP/IP Interface Module	✓	✓	✓
speedy dw22X-1121	Onboard controller w/EIP/PCCC Ethernet, savvyPanel	✓	✓	✓
T2-DEVNT-IN	DeviceNet Interface Module	✓	✓	✓
T2-PFNET-IN	ProfiNET Interface Module	✓	✓	✓
T2-PROFB-IN	Profibus DPV-1 Interface Module	✓	✓	✓
T2-BNTIP-IN	Bacnet IP Interface Module	✓	✓	✓
T2-BNTSP-IN	Bacnet RJ45 connector	✓	✓	✓
LA503846	Through-Door Ethernet Coupler RJ45-RJ45	✓	✓	✓
Programming Interface				
speedy dw21X	USB Interface Module	✓	✓	✓
T3-STICK-IN	Optistick parameter copying stick with Bluetooth	✓	✓	✓
Encoder Feedback				
T2-ENCOD-IN	5v Encoder feedback module for P2	✓	✓	✓
T2-ENCHT-IN	24v Encoder feedback module for P2	✓	✓	✓
EMC Filters				
T2-E3300-00	Optifilter, EMC input filter, 3-phase, 300A, IP00	✓	✓	✓
Brake Resistors (Case Type)				
OD-BR100-IN	DB Resistor, drive size 2 & 3, IP20, 100Ω, 200W	✓	✓	✓
OD-BRES4-IN	DB Resistor, drive size 4 & 5, IP20, 33Ω, 500W	✓	✓	✓
Brake Resistors (Enclosed, ventilated with over temp switch)				
Intermittent duty 10%, 10 sec				
CX503554	1 HP 230VAC, 190Ω, 12"x5"x5"	✓	✓	✓
CX503068	2 HP 230VAC, 95Ω, 12"x5"x5"	✓	✓	✓
CX503069	3 HP 230VAC, 63Ω, 12"x5"x5"	✓	✓	✓
CX503070	5 HP 230VAC, 38Ω, 12"x5"x5"	✓	✓	✓
CX503071	7.5 HP 230VAC, 19Ω, 12"x7"x5"	✓	✓	✓
CX503072	10 HP 230VAC, 19Ω, 12"x7"x5"	✓	✓	✓
CX503073	15 - 20 HP 230VAC, 12.6Ω, 12"x10"x5"	✓	✓	✓
CX503075	25 HP 230VAC, 7.5Ω, 12"x16"x5"	✓	✓	✓
CX503076	30 HP 230VAC, 6.3Ω, 19"x10"x5"	✓	✓	✓
CX503077	40 HP 230VAC, 4.9Ω, 19"x10"x5"	✓	✓	✓
CX503078	50 HP 230VAC, 3.9Ω, 19"x10"x5"	✓	✓	✓
CX503079	60 HP 230VAC, 3.3Ω, 19"x13"x5"	✓	✓	✓
CX503080	1 HP 460VAC, 750Ω, 12"x5"x5"	✓	✓	✓
CX503081	2 HP 460VAC, 375Ω, 12"x5"x5"	✓	✓	✓
CX503082	3 HP 460VAC, 250Ω, 12"x5"x5"	✓	✓	✓
CX503083	5 HP 460VAC, 150Ω, 12"x7"x5"	✓	✓	✓
CX503084	7.5 HP 460VAC, 100Ω, 12"x7"x5"	✓	✓	✓
CX503085	10 HP 460VAC, 75Ω, 12"x7"x5"	✓	✓	✓
CX503086	15 HP 460VAC, 50Ω, 12"x10"x5"	✓	✓	✓
CX503087	20 HP 460VAC, 38Ω, 12"x13"x5"	✓	✓	✓
CX503088	25 HP 460VAC, 30Ω, 12"x16"x5"	✓	✓	✓
CX503089	30 HP 460VAC, 25Ω, 19"x10"x5"	✓	✓	✓
CX503090	40 HP 460VAC, 19Ω, 19"x13"x5"	✓	✓	✓
CX503091	50 HP 460VAC, 15Ω, 19"x13"x5"	✓	✓	✓
CX503092	60 HP 460VAC, 12.6Ω, 19"x13"x5"	✓	✓	✓
CX503093	75 HP 460VAC, 10Ω, 26.5"x10"x5"	✓	✓	✓
CX503094	100 HP 460VAC, 7.5Ω, 26.5"x16"x5"	✓	✓	✓
CX503095	125 - 150 HP 460VAC, 6Ω, 28"x10"x10"	✓	✓	✓
Output Filters				
T2-M3008-20	Output filter, 8A, IP20	✓	✓	✓
T2-M3008-66	Output filter, 8A, IP66	✓	✓	✓
T2-M3012-20	Output filter, 12A, IP20	✓	✓	✓
T2-M3012-66	Output filter, 12A, IP66	✓	✓	✓
T2-M3018-66	Output filter, 18A, IP66	✓	✓	✓
T2-M3030-20	Output filter, 30A, IP20	✓	✓	✓
T2-M3075-20	Output filter, 75A, IP20	✓	✓	✓
T2-M3180-00	Output filter, 180A, IP00	✓	✓	✓
T2-M3300-00	Output filter, 300A, IP00	✓	✓	✓
RJ45 Data Cables & Splitters				
T-J4505-IN	Data cable, 0.5M, (RJ45 - RJ45)	✓	✓	✓
T-J4510-IN	Data cable, 1M, (RJ45 - RJ45)	✓	✓	✓
T-J4530-IN	Data cable, 3M, (RJ45 - RJ45)	✓	✓	✓
T-J45SP-IN	Data cable 3-way splitter (RJ45)	✓	✓	✓
T2-BNTSP-IN	RJ45 BacNet connector	✓	✓	✓
I/O Boards				
T-LOGIP-11	110VAC logic input isolator	✓	✓	✓
T-LOGIP-23	230VAC logic input isolator	✓	✓	✓
T3-2ROUT-IN	Relay output module	✓	✓	✓
T2-CASCD-IN	Cascade control plug in option board	✓	✓	✓
T2-EXTIO-IN	Extended I/O, plug in option board	✓	✓	✓

3-Phase Line Reactors for AC Drives

460 volts, 3% impedance, open construction for mounting in a protected enclosure

HP	Model	Amps	mH
1	LMAC341	2	12
2	LMAC342	4	6.5
5	LMAC345	8	3
7.5	LMAC347.5	12	2.5
10	LMAC3410	18	1.5
15	LMAC3415	25	1.2
25	LMAC3425	35	0.8
30	LMAC3430	45	0.7
40	LMAC3440	55	0.5
75	LMAC3475	100	0.3
100	LMAC34100	130	0.2
150	LMAC34150	200	0.11
200	LMAC34200	250	0.09
250	LMAC34250	320	0.075
300	LMAC34300	400	0.06
400	LMAC34400	500	0.05

Options:

230 VAC ratings
NEMA 1 & NEMA 4X enclosed units

**Consult
Factory**

drive.web smart drives

Add a **drive.web** Universal Automation Controller to any drive for unlimited automation capability (see pages 3-33):

- Powerful programmable control functions
- Peer-to-peer networking over Ethernet
- Smart iPad/Android or touch screen PC operation
- Internet access
- Unlimited additional I/O

	E3	P2
smarty2	dw248-DM-C2CD	dw244-DM-C2CD
smarty3	dw248-DM-C3CD	dw244-DM-C3CD
smarty4	dw248-DM-C4CD	dw244-DM-C4CD
smarty7	dw258-DM-S7PD	dw254-DM-S7PD

Smart Control + Peer-to-Peer Networking + ModbusTCP/IP

dw274 **drive.web speedy** interface for P2 models
dw276 **drive.web speedy** interface for V3 models
dw278 **drive.web speedy** interface for E3 models

Pack-1 Opt-1121 ModbusTCP/IP, EthernetIP, Process Lib, **savvyPanel**
Pack-2 Opt-1122 Pack 1 + Winder & Motion FB Libraries

savvyPanel touch -

5" dw230-050 operator station
7" dw260-070 operator station
9.7" dw230-097 operator station

Get **savvySFD** Signal Flow Diagram design tools

Get **savvy FREE** from www.driveweb.com

- Drill down to the details
- Drag & drop to connect

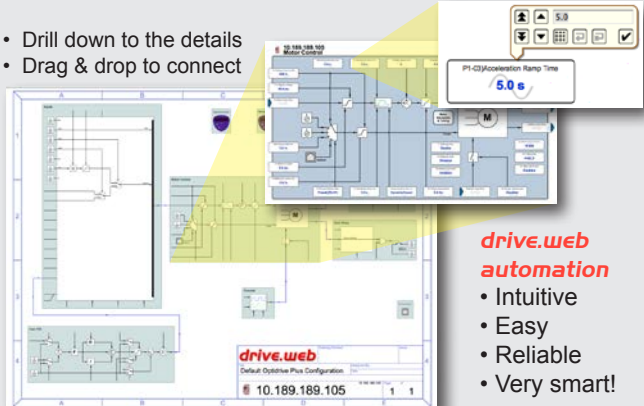

**drive.web
automation**

- Intuitive
- Easy
- Reliable
- Very smart!

E3 SINGLE PHASE

Single Phase Motor Controller

For Shaded Pole (SP) & Permanent Split Capacitor (PSC) motors used in direct drive, variable torque, fan and pump type applications only



The innovative E3 Single Phase motor controller, uses a unique boost control algorithm that ensures reliable starting and control.

- Energy saving
- Macros for fan & pump applications
- Built in PI control
- Bluetooth connectivity
- High frequency switching for quiet running in:
 - ~ Commercial and residential HVAC
 - ~ Fume extraction
 - ~ Laboratories
 - ~ Quiet locations

Expandable • Versatile • Economical

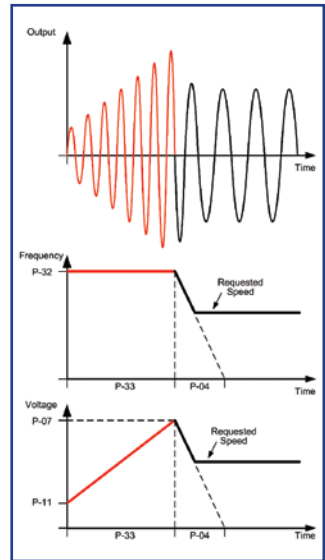

Basic IP20 or NEMA4X (outdoor rated) versions
 Basic or full featured systems drive
 Basic or peer-to-peer networking over Ethernet

SPECIFICATION

Output	Frequency	0 to 500Hz, 0.1Hz resolution
Supply options	Frequency	48 - 62 Hz, >0.98PF, inrush current < rated current
	Volts/Phases	100 - 132 volts max, 1-phase (0.5 - .75HP) 180 - 264 volts max, 1-phase (0.5 - 1.5HP)
Environment	Temperature	IP20, operating, -10 to 50°C max, storage, -40 to 60°C IP66, NEMA 4X, operating -10 to 40°C max, storage, -40 to 60°C
	Altitude	0-2000M, derate 1% per 100M above 1000M
	Humidity	up to 95%, non condensing
	Ingress	Basic IP20 Optional IP66 (NEMA 4X), outdoor rated
Control	Mode	V/F voltage vector, with energy optimizer
	PWM Hz	4 to 32kHz (effective)
	Skip Freq	Single point, user adjustable
	Boost	Automatic boost phase operation
	Stop modes	Coast / ramp / DC brake
	Setpoint ref	0-10VDC, 4-20mA, 0-20mA, Keypad, Modbus
	Presets	8 preset speeds
	PI control	Direct & analog input trim
Configurable I/O	Input 1	Programmable digital input
	Input/output 2	Selectable digital input / output
	Input 3	Configurable analog or digital input
	Input 4	Configurable analog or digital input
	Output 1	Configurable analog or digital output
	Relay 1	Normally open relay contact 30VDC 5A, 250VAC 6A
	Protection	Drive trip
Motor		Overload, over temp, short circuit, ground fault
Trip memory		Last 4 trips stored

THE BASICS

- Compact packaging
- Simple mechanical and electrical installation
- 50°C ambient rating
- 150% rating for 60 seconds, 175% for 2 seconds
- Simple basic set up
- Integral brake transistor (size 2, 100% rated)
- ModbusRTU serial port
- Remote keypad and display option
- T3-STICK plug-in for easy parameter up/down load



E3 Single Phase IP20

Single phase motor controller for use only with Shaded Pole (SP) or Permanent Split Capacitor (PSC) type motors on variable torque, direct drive fans and centrifugal pumps

STANDARD E3 1Ø IP20 DRIVES

Model	Supply	Motor	Power	Amps	Size
E3-110070-1012-01	1Ø, 115V	1Ø, 115V	0.5HP	7.0	1
E3-210105-1042-01	1Ø, 115V	1Ø, 115V	0.75HP	10.5	2
E3-120043-1012-01	1Ø, 230V	1Ø, 230V	0.5HP	4.3	1
E3-120070-1012-01	1Ø, 230V	1Ø, 230V	1HP	7.0	1
E3-220105-1042-01	1Ø, 230V	1Ø, 230V	1.5HP	10.5	2

DIMENSIONS & WEIGHT

Size	Height	Width	Depth	Weight
1	6.8" (173mm)	3.3" (83mm)	4.8" (123mm)	2.2lbs (1kg)
2	8.7" (221mm)	4.3" (110mm)	5.9" (150mm)	3.8lbs (1.7kg)



smart options

speedy control

savvyPanel vision



E3 SINGLE PHASE, NEMA 4X (IP66)

Single phase motor controller for use only with Shaded Pole (SP) or Permanent Split Capacitor (PSC) type motors in variable torque, fan and centrifugal pump applications

Switched version with keypad, display, speed pot, forward/off switch & power isolator switch

Unswitched version with keypad & display

For outdoor and harsh, dirty indoor environments

- 40°C ambient temperature
- Conduit cable entry
- Padlockable power switch
- Wash down duty
- ModbusRTU port
- Compact packaging
- All standard drive features included
- Brake switch standard on 230V, size 2
- Optional internal Ethernet
- Optional internal **drive.web** smart control
- Sunshade required for outdoor use
- Derate for operation > 40°C <= 50°C

NEMA 4X / IP66 DRIVES (outdoor rated)

Model	Supply	Motor	Power	Amps	Size
E3-120043-101#-01	1Ø, 230V	1Ø, 230V	0.5HP	4.3	1
E3-120070-101#-01	1Ø, 230V	1Ø, 230V	1HP	7.0	1
E3-220105-104#-01	1Ø, 230V	1Ø, 230V	1.5HP	10.5	2

A = Unswitched, B = Switched

DIMENSIONS & WEIGHT

Size	Height	Width	Depth	Weight
1	9.1" (232mm)	6.4" (161mm)	6.4" (162mm)	5.1lb (2.3kg)
2	10.1" (257mm)	7.4" (188mm)	7.2" (182mm)	7.7lb (3.5kg)



DC technology

K-Series single phase DC drives - up to 2HP

Regenerative & Non-regenerative

Enclosed, DIN rail mounting drives in elegant compact packages for both stand alone and systems applications.

Standard features include:

- Plug-in screw terminals
- Dual 115 & 230 volts, 50/60Hz supply
- Armature volts or tach feedback
- IP20 enclosure
- Output for ramps, speed demand, current demand
- Inputs for ramped speed, unramped speed, torque (current)
- Logic outputs for overload & trip
- Configurable level comparator & sign changer
- Standards: UL, cUL, CE



MODEL	RATING	FEATURES	TERMINALS
NON-ISOLATED			
K340	Armature current 3.4 amps 1/4HP 0.25kW @90Vdc 1/2HP 0.55kW @180Vdc Size 1.4"W x 4.2"H x 4.7"D	Max Speed Min Speed Up Ramp IR Comp I max	+10V Min Input + Common Run
K680	Armature current 6.8 amps 1/2HP 0.55kW @90Vdc 1HP 0.75kW @180Vdc Size 1.8"W x 4.2"H x 4.7"D	AVF/Tach switch Speed range switch AC voltage selector Field 1Amp 0.9x ac supply	Tach f/b
K1220	Armature current 12.2 amps 1HP 0.75kW @90Vdc 2HP 1.8kW @180Vdc Size 1.8"W x 4.2"H x 4.7"D		
ISOLATED			
K340i	Armature current 3.4 amps 1/4HP 0.25kW @90Vdc 1/2HP 0.55kW @180Vdc Size 2.4"W x 4.2"H x 4.7"D	Max Speed Min Speed Up Ramp Down Ramp Stability	+10V ref Min speed Input + Output +/- Common
K680i	Armature current 6.8 amps 1/2HP 0.55kW @90Vdc 1HP 0.75kW @180Vdc Size 2.8"W x 4.2"H x 4.7"D	I max IR Comp AVF/Tach switch Speed range switch AC voltage selector	Level O/P Level I/P Overload Trip Ramp O/P Demand O/P Speed O/P Current O/P + Speed I/P Torque I/P
K1220i	Armature current 12.2 amps 1HP 0.75kW @90Vdc 2HP 1.8kW @180Vdc Size 2.8"W x 4.2"H x 4.7"D	Level comparator	Tach f/b
4-QUADRANT, REGENERATIVE, REVERSING, ISOLATED			
K340XRI	Armature current 3.4 amps 1/4HP 0.25kW @90Vdc 1/2HP 0.55kW @180Vdc Size 2.4"W x 4.2"H x 4.7"D	Max Speed Min Speed Up Ramp Down Ramp Stability	+10V ref Min speed Level O/P Level I/P Overload Trip
K680XRI	Armature current 6.8 amps 1/2HP 0.55kW @90Vdc 1HP 0.75kW @180Vdc Size 2.8"W x 4.2"H x 4.7"D	I max IR Comp AVF/Tach switch Speed range switch AC voltage selector	Ramp O/P Demand O/P Speed O/P Current O/P + Speed I/P Torque I/P
K1220XRI	Armature current 12.2 amps 1HP 0.75kW @90Vdc 2HP 1.8kW @180Vdc Size 2.8"W x 4.2"H x 4.7"D	Level comparator	Tach f/b



Optional *drive.web smarty*

For complete process automation Model dw250-XAIO uses discrete I/O interface to provide:

- Ethernet networking
- Internet access
- Powerful function blockprogramming
- ModbusRTU and ModbusTCP/IP
- Additional remote I/O
- *savvyPanel* smart touch screens (see page 13)



High Speed Fuse Kits - DIN Rail Mounting

FLN-6.3	Line fuse kit	K340/i
FLL-6.3	Line/line fuse kit	K340/i
FLNR-6.3	Line & arm fuse kit	K340XRI
FLLR-6.3	Line/line & arm fuse kit	K340XRI
FLN-20	Line fuse kit	all non-regen K
FLL-20	Line/line fuse kit	all non-regen K
FLNR-20	Line & arm fuse kit	all regen K
FLLR-20	Line/line & arm fuse kit	all regen K

Single Phase DC Systems Drives

This family of single phase DC drives with isolated control circuitry, is designed to meet the most exacting requirements of high performance systems builders. It is a range of full featured products using advanced manufacturing technologies to give unequalled value and functionality to OEMs and System Integrators with world wide markets and demanding applications.

NON-REGEN MODELS

	230VAC, 180VDC	115VAC, 90VDC	FUSE KIT
400i (4 amps)	0.75HP	0.4HP	included
1600i (16 amps)	3HP	1.5HP	F2-30
3200i/32 (32 amps)	6HP	3HP	F2-60
3200i/48LL (48 amps)	7.5HP	4HP	F2-80
3200i/32C109 (32 amps)	8HP	5HP	F2-60

4-Q REGEN, REVERSING MODELS

	230VAC, 180VDC	115VAC, 90VDC	FUSE KIT
3600XRi/16	3HP	1.5HP	F3-30
3600XRi/32	6HP	3HP	F3-60
3600XRi/36	6.5HP	3HP	F3-60
3600XRi/36LL	10HP	6HP	F3-60
3600XRi/32C132	10HP	6HP	F3-60



Model 400i, up to 0.75HP
4" x 6.25" x 2" (100 x 160 x 50mm)

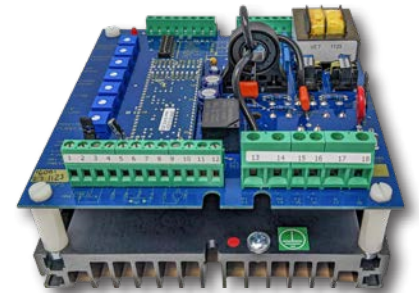

Model 1600i, up to 3HP
6.1" x 6.1" x 3.4" (150 x 150 x 85 mm)



Model 3200i, up to 7.5HP
6.1" x 8.0" x 4.2" (150 x 200 x 105 mm)



Model 3600XRi
Up to 32 amps - 6.9"x 8"x 3.2" (175x200x80 mm)
36 amps unit - 6.9"x 8"x 3.8" (175x200x95 mm)

Standard Features

- Approvals: CE
- Linear torque control
- Armature voltage or tach feedback
- Calibration range switches
- Speed reference 0-10V or 4-20mA
- Maximum and minimum speed settings
- Adjustable current limit
- Current range switch selectable (not on 400i)
- Independently adjustable up and down ramps
- 150% overload capacity, 30 second stall timer
- Stall relay contact output (transistor on 400i)
- Zero speed relay contact (transistor on 400i)
- Control fuses fitted (Power fuse on 400i)
- Start inhibit after power loss
- Power on and stall indicator LEDs
- Speed signal output
- Current signal output
- Ramp signal output
- Total demand signal output
- Dual supply voltage 110 / 230 VAC, 50/60Hz
- Suitable for shunt or PM motors
- IR compensation
- Stability adjustment

Additional Regen Drive Features

- Speed reference +/-10V or 4-20mA
- Speed trim input
- Independent up & down ramps in FWD & REV
- Separate adjustable current limits motor/brake
- Torque control in either 2 or 4 quadrants
- Relay for Stall, Zero speed, Reverse, Overload
- Control fuses fitted
- Fast, ramped or coast stop
- LEDs for + current, - current, stall & stall timer
- Momentary contact for reversing applications

Optional *drive.web smarty*

For complete process automation Model dw250-1107 uses discrete I/O interface to the drive and to provide:

- Ethernet networking
- Internet access
- Powerful function blockprogramming
- ModbusRTU and ModbusTCP/IP
- Additional remote I/O
- savvyPanel* smart touch screens (see page 13 for details)

dw260 screen with dw250 smarty



Enclosed Drives

Enclosed wall mounting versions of these drives and a wide range of other options are detailed in the "Modulus Drive Units" section of this catalog

Single Phase DC Drives for OEMs

Model 370 ... OEM Chassis Drives

Compact, DC drives designed for low cost, non-regenerative, non-isolated machine controls.

Basic Specification:

Rating: 1/4HP at 90VDC, 1/2HP at 180VDC

Maximum and minimum speed settings

Current limit

Acceleration pot

Suitable 110 or 230 volts, single phase, 50 or 60Hz (not isolated)

For use with permanent magnet or shunt field motors

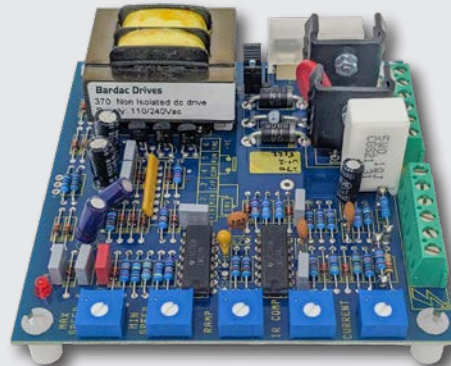

Dimensions

4" x 4" x 1.6" (100 x 100 x 40mm)

Models 400, 800, 1200 ... OEM DC Drives (up to 2HP)

Versatile, basic, low cost drives suitable for wide range of machine control applications

Model	Amps	Description	@ 180VDC	@ 90VDC	Dimensions
400	4 amps	Open chassis with screw terminals	0.75HP	0.38HP	5.2"x4.0"x1.6" (130x100x40mm)
800	8 amps	Open chassis with screw terminals	1.5HP	0.75HP	5.2"x4.0"x2.8" (130x100x70mm)
1200	12 amps	Open chassis with screw terminals	2.0HP	1.0HP	5.2"x4.0"x2.8" (130x100x70mm)
400E	4 amps	Enclosed NEMA 1 with pot, switch, fuse	0.75HP	0.38HP	9.9"x7.0"x3.8" (250x177x95 mm)
800E	8 amps	Enclosed NEMA 1 with pot, switch, fuse	1.5HP	0.75HP	9.9"x7.0"x3.8" (250x177x95 mm)
1200E	12 amps	Enclosed NEMA 1 with pot, switch, fuse	2.0HP	1.0HP	9.9"x7.0"x3.8" (250x177x95 mm)
400ER	4 amps	Enclosed, pot, switch, brake, reverse, fuse	0.75HP	0.38HP	9.9"x7.0"x3.8" (250x177x95 mm)
800ER	8 amps	Enclosed, pot, switch, brake, reverse, fuse	1.5HP	0.75HP	9.9"x7.0"x3.8" (250x177x95 mm)
1200ER	12 amps	Enclosed, pot, switch, brake, reverse, fuse	2.0HP	1.0HP	9.9"x7.0"x3.8" (250x177x95 mm)

Standard features:

Linear torque control

Armature voltage or tach feedback with IR compensation

Calibration range switches (no component changes)

Speed reference 0-10V or 4-20mA

Maximum and minimum speed settings

Adjustable current limit

Independently adjustable up and down ramps

150% overload capacity with 30 second stall timer

Stall and Zero Speed relay driver outputs

Power fuse (up to 12 amps)

Power on and stall indicator LEDs

Stability adjustment

Speed, Ramp Speed and Current signal outputs

International supply voltages 110 / 230 VAC, 50/60hz (not isolated)

Suitable for shunt wound or permanent magnet motors



Model 1200E

DC Servo Drives

These drives are designed for small, high performance position and speed control applications such as robotics, mechanical handling, automated assembly, packaging processes, machine tool axis, etc.

The units are miniature, fast response, reversing, linear transistor drives for brushed DC motors with armatures up to 48 volts. They operate from either a smoothed, unregulated, rectified DC, or battery supply, and include built in thermal protection, current limit with short term overcurrent capacity and resettable overload trip.

The control circuits are designed to ensure extremely low noise emissions, and will meet the most stringent of EMC (Electro-Magnetic Compliance) requirements.

Model 200XLV 4-Quadrant DC Drive

Miniature linear amplifier with built in "P" or "P+I" or "PID" (Proportional, Integral, Derivative) for closed loop position, speed or torque control.

Optional configurations:

1. Speed control, armature voltage feedback with IR compensation.
2. Speed control, tach feedback.
3. Position control, position feedback.
4. Torque control with armature current feedback

Specifications

Model	Max Amps	Dimensions
200XLV	2	3.25" x 1.65" x 1.65" (82x40x40mm)



Models 400XLV, 800XLV & 1200XLV 4-Quadrant DC, PWM Servo Drives

These products are designed for small, high performance position and speed control applications such as robotics, mechanical handling, automated assembly, packaging processes, machine tool axis, etc.



Model	Max Amps	Dimensions
400XLV	4	4.2" h x 2.4" w x 4.75" d (106 x 61 x 120mm)
800XLV	8	4.2" h x 2.75" w x 4.75" d (106 x 70 x 120mm)
1200XLV	12	4.2" h x 2.75" w x 4.75" d (106 x 70 x 120mm)



Standard Features

- Speed, or Torque control modes
- Extremely low RF noise emissions
- Ready indicator light
- Motor voltage range: +/-6 VDC to +/-48 VDC
- Armature current (see specifications below)
- Supply voltage 12 to 48 VDC
- Precision 5v and 10v references
- Differential setpoint inputs (300K ohms)
- Overload trip
- Thermal protection
- Adjustable Maximum Speed
- Adjustable IR Compensation for arm volts f/b
- Plug-in terminals
- DIN rail mounting (optional on 200XLV)

smarty Motion Control Options

Full featured motion controller with:

- Trapezoidal and cam motion functions
- Encoder speed & position feedback
- Ethernet, multi-axis networking
- **savvyPanel touch** industrial displays (see page 13)



PL Series ...digital dc drives



PL265
Up to 400HP

PL/X145
Up to 200HP

PL/X50
Up to 75HP

PL/X980
Up to 1940HP

PL/X440
Up to 900HP

up to
2000+HP

LA503846

dw Ethernet
Through-Panel
Port for closed
door system
access



Standard Features

- Total digital control
- Basic peer-to-peer link
- 40 character backlit display
- Friendly, easy menu structure
- Modern, compact packaging
- Extensive, flexible, plug-in I/O
- RS232 serial port
- Easy configuration saving & cloning
- Built-in automatic field controller
- Built in programmable control functions for PID, winders, orientation, etc.
- Tach, encoder & arm volts feedback
- Easy reliable autotune

All suffix d PL/X drives include an embedded **speedy** Automation Controller (dw221) for safe, doors closed, start up & operation with:

- Easy USB port interface
- Peer-to-peer Ethernet communications
- **drive.web** programmable control
- ModbusTCP over Ethernet
- Easy, safe, **savvyPanel** "Quick Start"
- see pages 23 & 24 for dw221 details -

Optional:

- ModbusRTU RS485 serial port
- Devicenet, Profibus DP, fieldbus

powerDRIVE Packages

PL/X DC drives up to 1200 horsepower are available in compact **powerDRIVE** packages complete with:

- Main contactor
- High speed 3-phase line fuses
- High speed armature fuse
- High speed control/field fuses
- Line filter (100HP & up)
- USB & Ethernet interface with **speedy dw221**
- Optional motor blower starter (100HP & up)



Key Features

Analog Inputs & Outputs

8 analog inputs & 4 analog outputs (12 bits)
 All outputs short circuit protected
 All inputs over voltage protected up to +50v
 Inputs configurable 5 to 30v
 Input volts programmable up to +/-30v

Digital Inputs & Outputs

17 digital inputs & 7 digital outputs
 Digital I/O short circuit protected
 Digital inputs over volts protected to +50v
 (with settable switching levels)
 Digital outputs over volts protected to +50v

Speed Feedback - Standard

Analog tach
 Encoder
 Armature voltage
 Encoder + armature volts
 Encoder + analog tach

Field Configurations

Fixed Current
 Fixed voltage
 Automatic field weakening
 Delayed field quench
 Standby field setting
 Field economy

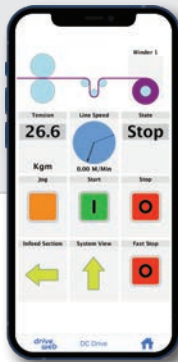

Diagnostic Monitoring

Scope terminal monitors selectable values
 All analog input voltages
 All digital input states
 All analog output voltages
 All digital output states
 Tach volts
 Motor arm volts & amps
 Field current
 Output power Kw
 AC supply volts

User Configurable Software Functions

PID blocks, Parameter profiler, Winder reel diameter calculator, Winder taper tension calculator, Winder torque/inertia/friction compensator, Preset speed function, Two summers, Software "motorized pot", Interval timer, Current profiling, Zero speed with shaft position lock, Jog / crawl functions, Two filters, Dual motor swap, Latch, Sample & hold function, Auto self-tune current loop, Linear and S-ramps, Slack take-up, Batch Counter, Draw control.

Engineered Configuration Packages

Pre-configured generic apps are available for Open & Closed Loop Winders, Position Controls, Coordinated Line Drives, Indexing, registration and others.

* Included with all *powerDRIVES* and size 4 & 5 *basicDRIVES*

Safe, "Doors Closed" Start Up & Operation

The optional *duw221* Automation Controller is embedded as standard in size 4 & 5 for easy system wide access to configure, connect & control.

Protection

Interline device networks
 High energy MOV's
 Instantaneous overcurrent
 Overcurrent (inverse time)
 Field fail and overcurrent
 Motor over temperature
 SCR (thyristor) over temp
 Main power phase loss
 Armature over volts
 Over speed protection
 Speed feedback mismatch
 Stall protection
 Standstill logic
 SCR (Thyristor) trigger failure
 Digital output short circuit

Communications Ports*

drive.web peer-to-peer Ethernet
 ModbusTCP/IP Ethernet
 USB port for easy network wide set up
 Serial port (RS232)

Optional Communications

Ethernet: EIP (PCCC)
 ModbusRTU
 Profibus DP

Easily add a *savvyPanel* touch screen HMI with secure WiFi interface

- Simple, intuitive configuration techniques with clear display of information
- No pots or switches to set
- Accurate display of voltages and currents
- Positive displacement pushbuttons for tactile feel
- High power processor and large memory will ensure ease of product enhancement in the future
- 2-button reset gets users back to OEM set up
- Powerful *savvy* graphical configuration, diagnostics & system design tools



The powerful *savvy* configuration tools are used for the PL Series DC drives, AC drives, *drive.web* programmable controllers, *savvyPanel* operator stations & complete systems.



↑ 75 HP, PLX50/123

powerPLX50/123 →
With fuses, contactor
& power components
(shown hinged open
for easy access)

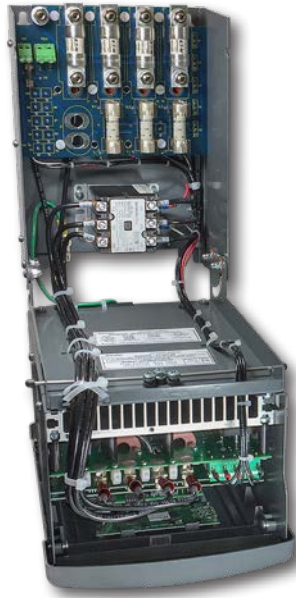

↑ 400 HP, PL265/630

powerPL265/630 →
With fuses, contactor
& power components
(shown with optional
motor blower starter)



Models & Ratings

4-Quadrant, Regenerative Drives

HP @ 500V arm 460VAC	HP @ 240V arm 230VAC	Armature Amps DC @ 40°C	Field Amps DC power(basic)	powerDRIVE Model	Dimensions W x H x D (weight) inches (LBS)	basicDRIVE Model	Dimensions W x H x D (weight) inches (LBS)	Line Reactor Model
20	10	36	5(8)	powerPLX15/36d	8.5 x 11.4 x 11.7 (26)	PLX15/36d	8.5 x 11.4 x 6.9 (16)	LM37
30	10	51	5(8)	powerPLX20/51d	8.5 x 11.4 x 11.7 (26)	PLX20/51d	8.5 x 11.4 x 6.9 (16)	LM52
60	25	99	5(8)	powerPLX40/99d	8.5 x 11.4 x 11.7 (30)	PLX40/99d	8.5 x 11.4 x 6.9 (17)	LM120
75	35	123	5(8)	powerPLX50/123d	8.5 x 11.4 x 11.7 (30)	PLX50/123d	8.5 x 11.4 x 6.9 (17)	LM120
100	50	164	10(16)	powerPLX65/164d	16 x 33 x 9.7 (80)	PLX65/164d	8.5 x 16.2 x 8.6 (27)	LM150
125	60	205	10(16)	powerPLX85/205d	16 x 33 x 9.7 (80)	PLX85/205d	8.5 x 16.2 x 8.6 (27)	LM195
150	75	270	10(16)	powerPLX115/270d	16 x 33 x 9.7 (82)	PLX115/270d	8.5 x 16.2 x 8.6 (28)	LM240
200	100	330	10(16)	powerPLX145/330d	16 x 33 x 9.7 (89)	PLX145/330d	8.5 x 16.2 x 8.6 (28)	LM300
250	125	405	20(32)	powerPLX185/405d	16 x 43.5 x 14.4 (143)	PLX185/430d	8.5 x 19.9 x 14.4 (43)	LM375
300	150	480	20(32)	powerPLX225/480d	16 x 43.5 x 14.4 (145)	PLX225/530d	8.5 x 19.9 x 14.4 (45)	LM480

2-Quadrant, Non-Reversing Drives

HP @ 500V arm 460VAC	HP @ 240V arm 230VAC	Armature Amps DC @ 40°C	Field Amps DC power(basic)	powerDRIVE Model	Dimensions W x H x D (weight) inches (LBS)	basicDRIVE Model	Dimensions W x H x D (weight) inches (LBS)	Line Reactor Model
20	10	36	5(8)	powerPL15/36d	8.5 x 11.4 x 11.7 (26)	PL15/36d	8.5 x 11.4 x 6.9 (16)	LM37
30	10	51	5(8)	powerPL20/51d	8.5 x 11.4 x 11.7 (26)	PL20/51d	8.5 x 11.4 x 6.9 (16)	LM52
60	25	99	5(8)	powerPL40/99d	8.5 x 11.4 x 11.7 (30)	PL40/99d	8.5 x 11.4 x 6.9 (17)	LM120
75	35	123	5(8)	powerPL50/123d	8.5 x 11.4 x 11.7 (30)	PL50/123d	8.5 x 11.4 x 6.9 (17)	LM120
100	50	164	10(16)	powerPL65/164d	16 x 33 x 9.7 (80)	PL65/164d	8.5 x 16.2 x 8.6 (27)	LM150
125	60	205	10(16)	powerPL85/205d	16 x 33 x 9.7 (80)	PL85/205d	8.5 x 16.2 x 8.6 (27)	LM195
150	75	270	10(16)	powerPL115/270d	16 x 33 x 9.7 (82)	PL115/270d	8.5 x 16.2 x 8.6 (28)	LM240
200	100	330	10(16)	powerPL145/330d	16 x 33 x 9.7 (89)	PL145/330d	8.5 x 16.2 x 8.6 (28)	LM300
250	125	405	20(32)	powerPL185/405d	16 x 43.5 x 14.4 (143)	PL185/430d	8.5 x 19.9 x 14.4 (43)	LM375
300	150	480	20(32)	powerPL225/480d	16 x 43.5 x 14.4 (143)	PL225/530d	8.5 x 19.9 x 14.4 (45)	LM480
400	200	630	20(32)	powerPL265/630d	16 x 43.5 x 14.4 (154)	PL265/630d	8.5 x 19.9 x 14.4 (45)	LM600

basicDRIVES must be installed with new contactor and the correct high speed SCR fuses to maintain the warranty
drive.web options see pages 25 - 27

USB cable for programming (USB A to USB-C), 2M long - part number LA504302, please call +410-604-3400
Computer RS232 Communications Cable - Drive to DB9 - part number LA102595, included with every drive
For details of Drive Isolation Transformers, Line Reactors and Line Filters, please call +410-604-3400

PL-Series Drives to 2000HP

Models & Ratings

DC drives 400 HP to 2000 HP are normally available as **basicDRIVES** but can be supplied with **powerKITS** including:

- High speed fuses for line, armature & field
- Main DC contactor
- Line filter
- Flexible bus bar kits

(**basicDRIVES** must be installed with new power components to maintain the warranty)

Drives are available for either 6-pulse or 12-pulse, 460, 600 or 690 VAC configurations - please call for further information.

SAFE, "DOORS CLOSED" START UP AND OPERATION

Drive models with suffix "d" include a speedy dw221 onboard controller with drive.web



DC Drives - 500 VDC Armature, 480VAC Supply

HP @	ARMATURE AMPS DC @ 40°C	FIELD AMPS DC Basic(Optional)	basic-DRIVE 4-QUAD REGEN REVERSING	basic-DRIVE NON-REVERSING	DIMENSIONS W x H x D (weight) INCHES (LBS) TOP CABLE ENTRY	OVERLOAD RATING
400	650	32 (50)	PLX275/650d	PL275/650d	10 x 30 x 13.8 (120)	150%, 25 SECS
450	750	32 (50)	PLX315/750d	PL315/750d	10 x 30 x 13.8 (120)	150%, 25 SECS
500	850	32 (50)	PLX360/850d	PL360/850d	10 x 30 x 13.8 (120)	150%, 25 SECS
575	950	32 (50)	PLX400/950d	PL400/950d	10 x 30 x 13.8 (120)	150%, 25 SECS
650	1050	32 (50)	PLX440/1050d	PL440/1050d	10 x 30 x 13.8 (120)	100%, CONT
750	1250	64	PLX520/1250d	PL520/1250d	20 x 30 x 13.8 (285)	150%, 25 SECS
895	1450	64	PLX600/1450d	PL600/1450d	20 x 30 x 13.8 (285)	150%, 25 SECS
1000	1650	64	PLX700/1650d	PL700/1650d	20 x 30 x 13.8 (285)	150%, 25 SECS
1140	1850	64	PLX800/1850d	PL800/1850d	20 x 30 x 13.8 (285)	150%, 25 SECS
1260	2050 @35°C	64	PLX900/2050d	PL900/2050d	20 x 30 x 13.8 (285)	150%, 25 SECS
1380	2250 @35°C	64	PLX980/2250d	PL980/2250d	20 x 30 x 13.8 (285)	100%, CONT

DC Drives - 600 VDC Armature, 600VAC Supply

480	650	32 (50)	PLX275MV/650d	PL275MV/650d	10 x 30 x 13.8 (120)	150%, 25 SECS
550	750	32 (50)	PLX315MV/750d	PL315MV/750d	10 x 30 x 13.8 (120)	150%, 25 SECS
630	850	32 (50)	PLX360MV/850d	PL360MV/850d	10 x 30 x 13.8 (120)	150%, 25 SECS
700	950	32 (50)	PLX400MV/950d	PL400MV/950d	10 x 30 x 13.8 (120)	150%, 25 SECS
775	1050	32 (50)	PLX440/MV/1050d	PL440MV/1050d	10 x 30 x 13.8 (120)	100%, CONT
925	1250	64	PLX520MV/1250d	PL520MV/1250d	20 x 30 x 13.8 (285)	150%, 25 SECS
1075	1450	64	PLX600MV/1450d	PL600MV/1450d	20 x 30 x 13.8 (285)	150%, 25 SECS
1220	1650	64	PLX700MV/1650d	PL700MV/1650d	20 x 30 x 13.8 (285)	150%, 25 SECS
1370	1850	64	PLX800MV/1850d	PL800MV/1850d	20 x 30 x 13.8 (285)	150%, 25 SECS
1510	2050 @35°C	64	PLX900MV/2050d	PL900MV/2050d	20 x 30 x 13.8 (285)	150%, 25 SECS
1660	2250 @35°C	64	PLX980MV/2250d	PL980MV/2250d	20 x 30 x 13.8 (285)	100%, CONT

DC Drives - 700 VDC Armature, 690VAC Supply

550	650	32 (50)	PLX275HV/650d	PL275HV/650d	10 x 30 x 13.8 (120)	150%, 25 SECS
650	750	32 (50)	PLX315HV/750d	PL315HV/750d	10 x 30 x 13.8 (120)	150%, 25 SECS
735	850	32 (50)	PLX360HV/850d	PL360HV/850d	10 x 30 x 13.8 (120)	150%, 25 SECS
820	950	32 (50)	PLX400HV/950d	PL400HV/950d	10 x 30 x 13.8 (120)	150%, 25 SECS
900	1050	32 (50)	PLX440HV/1050d	PL440HV/1050d	10 x 30 x 13.8 (120)	100%, CONT
1080	1250	64	PLX520HV/1250d	PL520HV/1250d	20 x 30 x 13.8 (285)	150%, 25 SECS
1250	1450	64	PLX600HV/1450d	PL600HV/1450d	20 x 30 x 13.8 (285)	150%, 25 SECS
1420	1650	64	PLX700HV/1650d	PL700HV/1650d	20 x 30 x 13.8 (285)	150%, 25 SECS
1600	1850	64	PLX800HV/1850d	PL800HV/1850d	20 x 30 x 13.8 (285)	150%, 25 SECS
1770	2050 @35°C	64	PLX900HV/2050d	PL900HV/2050d	20 x 30 x 13.8 (285)	150%, 25 SECS
1940	2250 @35°C	64	PLX980HV/2250d	PL980HV/2250d	20 x 30 x 13.8 (285)	100%, CONT

DC powerDRIVES - 500 VDC Armature, 480 VAC Supply & powerKITS

HP @ 500 VDC 460 VAC	ARMATURE AMPS DC @40°C	FIELD AMPS DC	FRAME SIZE	powerDRIVE w/contactor & fuses & <i>dw221 speedy</i>	Contact Kit Contactor + mount bus bars & h/w	Fuse Kit Line, Regen Arm & Aux Fuses + mountings + h/w	Fan Supply Kit 460/230V Transfmr Fuses + h/w
----------------------------	------------------------------	------------------	---------------	--	--	--	--

REGENERATIVE, REVERSING, 4-QUADRANT DRIVES

400	650	32 (50)	4	powerPLX275/650v2d	CON-800V700A	FPX650	FANSUPPLY4
450	750	32 (50)	4	powerPLX315/750v2d	CON-800V850A	FPX750	FANSUPPLY4
500	850	32 (50)	4	powerPLX360/850v2d	CON-800V850A	FPX850	FANSUPPLY4
575	950	32 (50)	4	powerPLX400/950v2d	CON-800V1000A	FPX950	FANSUPPLY4
600	1000	64	5	powerPLX520/1000d	CON-800V1200A	FPX1000	FANSUPPLY5
700	1150	64	5	powerPLX520/1150d	CON-800V1200A	FPX1150	FANSUPPLY5
800	1350	64	5	powerPLX600/1350d	CON-800V1750A	FPX1350	FANSUPPLY5
1000	1650	64	5	powerPLX700/1650d	CON-800V1750A	FPX1650	FANSUPPLY5
1100	1750	64	5	powerPLX800/1750d	CON-800V2000A	FPX1750	FANSUPPLY5
1200	1950	64	5	powerPLX900/1950d	CON-800V2000A	FPX1950	FANSUPPLY5

NON-REGENERATIVE, 2-QUADRANT DRIVES

400	650	32 (50)	4	powerPL275/650v2d	CON-800V700A	FP650	FANSUPPLY4
450	750	32 (50)	4	powerPL315/750v2d	CON-800V850A	FP750	FANSUPPLY4
500	850	32 (50)	4	powerPL360/850v2d	CON-800V850A	FP850	FANSUPPLY4
575	950	32 (50)	4	powerPL400/950v2d	CON-800V1000A	FP950	FANSUPPLY4
700	1150	64	5	powerPL520/1150d	CON-800V1200A	FP1150	FANSUPPLY5
800	1350	64	5	powerPL600/1350d	CON-800V1750A	FP1350	FANSUPPLY5
1000	1650	64	5	powerPL700/1650d	CON-800V1750A	FP1650	FANSUPPLY5
1100	1750	64	5	powerPL800/1750d	CON-800V2000A	FP1750	FANSUPPLY5
1200	1950	64	5	powerPL900/1950d	CON-800V2000A	FP1950	FANSUPPLY5

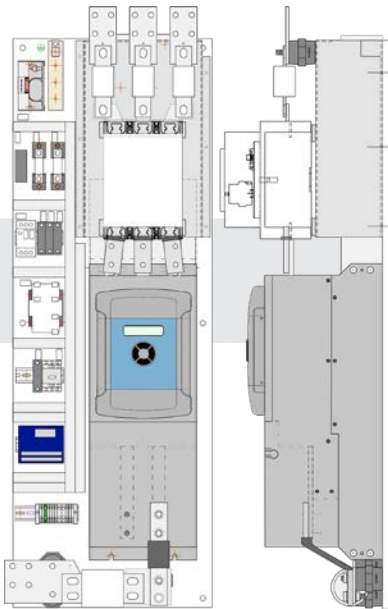

Size 4 powerPL/X315 - 400

NOTE 1:

To encourage "doors closed", safe start up & maintenance practices, all suffix d PL/X drives are fitted with a *dw221 speedy* with isolated USB and Ethernet ports as standard for full remote configuration & control access.

NOTE 2:

Due to the weight and dimensions, size 5 powerDRIVES are shipped in two parts (basic drive & power package panel) that will need to be assembled on site

Frame 4 Dimensions			
Drive	OW	OH	OD
powerPL275	18.5"	53.0"	14.9"
powerPLX275	18.5"	53.0"	14.9"
powerPL315	18.5"	56.0"	16.0"
powerPLX315	19.3"	56.0"	16.0"
powerPL360	18.5"	60.0"	16.9"
powerPLX360	19.3"	60.0"	16.9"
powerPL400	18.5"	60.0"	16.9"
powerPLX400	19.3"	63.9"	16.9"
Frame 5 Dimensions			
All frame 5 drives	30.0"	67.0"	16.0"

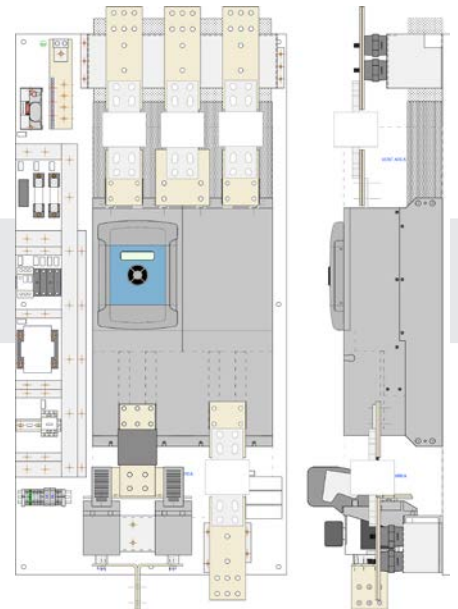

Size 5 powerPL/X520 - 900

PLXdd Separate Stack Controller

The PLXdd is a great retrofit option for controlling large separate SCR stacks in either 6 or 12-pulse DC drive configurations and also for wound rotor motor SCR stack control. The unit has all the standard PL/X series drive features together with:

- Available for stacks up to 690 volts AC, 700 volts DC
 - Built-in 32 amps fully automatic field controller (optional 50 amps rating)
 - Separate gate pulse driver unit for greater noise immunity and reliability
 - Ethernet and *drive.web* distributed control
 - Optional current transformers
- Please call for details



savvy tools for the PL/X DC drives

drive.web automation

- Intuitive
- Easy
- Reliable
- Very smart!

click on a parameter to open the setter

click on a function block to drill down to the detail

drive.web
Default PL-Series Configuration
192.168.1.4

↑ View the drive Signal Flow Diagram or
← View the drive in Engineering Info

- Import or export data
- Monitor trend charts
- Edit the configuration
- Drag & drop links
- Access multiple drives

drive.web smart drives



Add a **drive.web** module to any drive for unlimited automation capability:

- Powerful programmable control functions
- Peer-to-peer networking over Ethernet
- Smart iPad/Android or touch screen PC operation
- Internet access

smarty - adds programmable control & extra I/O
speedy - adds programmable control & gateway

- Get clear graphical signal flow system diagrams.
- Send event driven emails from your drive.
- All in one unique, intuitive, environment.

powerSL Series

Analog DC drives - up to 200HP
powerSLX Regen, reversing drive + field controller
powerSL Non-reversing drive + field controller
powerSLE Non-reversing OEM drive.
 Please call for details



Power Quality For DC Drives

Drive Isolation Transformers

Standard specification:
 NEMA 1 enclosed for indoor use
 K-factor 4
 Windings: Delta Primary, Wye Secondary
 Aluminum or Copper windings as indicated
 Taps at ± 5%
 Approvals: UL, cUL

Options
 Outdoor enclosures
 Frequencies other than 60Hz
 Voltages other than 230/460/575 pri, 230/460 sec
 Special Taps
 Fungus Proofing
 80°C & 115°C Rise
 Copper Windings
 Electrostatic Shield
 K-13, K-20, K-30

Discount Schedule SX-1

Model	Specification
DIT3**	3KVA - Cu (2HP)
DIT6**	6KVA - Cu (5HP)
DIT11**	11KVA - Al (7.5HP)
DIT14**	14KVA - Al (10HP)
DIT20**	20KVA - Al (15HP)
DIT27**	27KVA - Al (20HP)
DIT34**	34KVA - Al (25HP)
DIT40**	40KVA - Al (30HP)
DIT51**	51KVA - Al (40HP)
DIT63**	63KVA - Al (50HP)
DIT75**	75KVA - Al (60HP)
DIT93**	93KVA - Al (75HP)
DIT118**	118KVA - Al (100HP)
DIT145**	145KVA - Al (125HP)
DIT175**	175KVA - Al (150HP)
DIT220**	220KVA - Al (200HP)
DIT275**	275KVA - Al (250HP)
DIT330**	330KVA - Al (300HP)
DIT440**	440KVA - Al (400HP)
DIT550**	550KVA - Al (500HP)
DIT660**	660KVA - Al (600HP)

Line Reactors For 3-Phase DC Drives

Model Number	HP. at 230V	HP. at 460V	Arm Amps	Dimensions W x D x H	Mount Holes H x W	Weight LBS
LM18	5	10	20	6.0"x4.8"x3.1"	2.1"x2.0"	9
LM37	10	20	41	7.2"x5.6"x3.4"	2.3"x3.0"	11
LM52	15	30	58	7.2"x5.6"x3.8"	2.6"x3.0"	14
LM67	20	40	75	9.0"x7.0"x4.8"	3.2"x3.0"	23
LM82	25	50	91	9.0"x7.0"x4.8"	3.2"x3.0"	24
LM120	35	75	133	10.8"x8.2"x5.6"	3.5"x3.6"	43
LM150	40	100	166	10.8"x8.3"x5.6"	3.5"x3.6"	47
LM195	60	125	216	9.0"x7.1"x4.9"	3.2"x3.0"	29
LM240	75	150	266	10.8"x8.4"x5.8"	3.2"x3.6"	40
LM300		200	333	10.8"x8.4"x6.0"	4.2"x3.6"	48
LM375	100	250	416	10.8"x8.2"x7.3"	4.2"x3.6"	68
LM480	150	300	533	14.8"x14.0"x10.2"	5.9"x4.6"	125
LM600		400	666	15.5"x14.0"x11.5"	6.8"x4.6"	155
LM750	200	500	833	15.5"x14.0"x13.0"	6.8"x4.6"	180
LM900		600	1000	15.5"x14.0"x15.5"	9.3"x4.6"	290
LM1125		750	1250	22.0"x20.0"x14.8"	9.5"x7.2"	400

Line Filter



LF3 Line Filter
 LF3-FK Line Filter Fuse Kit

Engineering & Support



AC and DC motors from fractional to over 2000 HP

All speed ranges, duties, enclosures and voltages complete with a full range of accessories such as encoders, tachs, thermal protection, brakes, blowers, filters, brushes and slide bases. Please call for details and competitive pricing.

Modulus Packaged Drives

Modulus solutions are a range of standard, pre-engineered drive packages with a selection of options for wide range common applications.

Using the flexible **drive.web** programmable automation technology it is possible to adapt a small range of hardware configurations to a wide range of applications thereby keeping design and manufacturing costs to a minimum.

Modulus drives are available either as packages mounted on an open panel, **Modulus P**, or as assemblies installed in an enclosure, **Modulus E**, to suit the type of operating environment and the control scheme required.

Every **Modulus** project is accompanied by a detailed, 50-point, Quality Control Report covering every facet of the product, its design, construction, testing and shipping.



User manuals for all products are available from www.bardac.com

Online Product Support

Using innovative, interactive, Internet online technologies we can provide either product training or product support through your browser from the comfort of your desk! Simply connect via your browser and get live interactive support where ever you are - with savvy running on your computer call +410-604-3400 and in less than a minute an engineer will be able to see your system live and give you the support you need.

... it's as easy as that!

Our support view

Internet

Unbeatable!

Your plant view

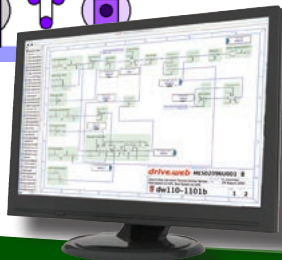

Online Training

Online product training courses are scheduled every week with options for users of all levels of interest and ability.

Level 1 - drive.web introductory seminar - 1½ hours - Free!

This provides an overview of the **drive.web** automation technology. Learn how to connect to drives, create drive “phantoms”, navigate systems, create signal flow diagrams and system drawings, find information, identify object attributes, make connections, show trend charts, build **savvyPanel** operator stations, etc.

Level 2 - drive.web design technology course - 3 hours (Level 1 is a prerequisite)

Covers configuration of drives, basic system design concepts, Ethernet networking, password protection, system safety

Level 3 - drive.web system design and application courses (Level 2 is a prerequisite)

3a) Drive and device interfaces - 2 hours

Covers the use of “Templates” and “Helpers” for documented drives, generic ModbusRTU master interfaces to third party drives, operator stations, etc.

3b) Winder Control Systems - 3 hours

Covers standard solutions for open loop CTCW winders, closed loop dancer controlled winders and closed loop load cell controlled winders.

3c) Encoder Control Systems - 3 hours

Covers applications such as “electronic line shaft”, spindle orientation, registration and position control.

3d) Advanced Ethernet, Internet Access and Security - 3 hours

Covers local and wide area network configuration, IP addressing, user access and device and system password protection.

For course details, registration, international training options and charges please call us at 1-888-667-7333 (toll free USA 888-ON SPEED) or international at +410-604-3400. Alternatively please contact training@driveweb.com

Terms of Sale & Payment

Complete Terms & Conditions of Sale are shown at www.bardac.com. Net 30 day credit terms are available subject to prior approval. Credit card payments are only accepted for payments made at the time of service or shipment of products and will be subject to a 4% surcharge.

Field Service, Service Center Repair, Training and Start-up - Call +410-604-3400 Rates for the Continental United States

Charge Basis

Rates (US\$)

a. Basic Rate - Field Service, Training & Start-up Assistance - up to 8 hours daily Monday to Friday, 7am to 6pm	\$220 per hour
b. Standard Overtime - Weekdays 6pm to 7am & all day Saturday - Total work time not to exceed 12 hrs in any 24 hrs	\$330 per hour
c. Special Overtime - Sundays, Holidays and excess of 8 hours on Saturday	\$440 per hour
d. Overnight - Includes meals, and hotel accommodation	\$400 per night
e. Auto Travel - Covering cost of use of company or personal cars, distance to and from the local office	\$0.75 per mile
f. Public Transport - Rental cars, Air fares, etc.	Cost + 10%
g. Holdover & Standby Time	Same as service
h. Travel Time - Time taken from Bardac to job site and return	Same as service
i. Basic Rate - Service Center Repair charges - Diagnosis & repair time	\$150 per hour + parts
j. Design or application engineering services	\$240 per hour

- Notes:
1. Minimum service billing is 4 hours for field services, 1 hour for service center services.
 2. Parts, materials, special visas, duties, and extraordinary expenses will be charged extra.
 3. Warranty credits will be identified on the Daily Field Service Report.

For rates and availability of sales and service outside the US, please call +410-604-3400

24/7 Tech Support

During normal business hours basic tech support will be provided free of charge

Outside normal business hours call +410-604-3535. Tech support will be provided at \$440/hour (minimum of 1/2 hour per call) and this must be paid for with a credit card at the time of service.

Bardac drives

drive.web

Bardac ...the safe bet!

Everything normally in stock!

Bardac Corporation

40 Log Canoe Circle
Stevensville, MD 21666 USA

bardac.com
driveweb.com
AutomationThings.com

Phone International **+410-604-3400**
Phone US Toll Free **1-888-667-7333**
1-888-ON SPEED
Fax **+410-604-3500**

Catalog 2025.1



bardac.com

INDEX

- 600 Volts AC Drives 38, 41
- A
 - K Series DC Drives 48
- AC Drives 34
 - Closed Loop Vector 36
 - General Purpose AC Drives 35, 42
 - HVAC & Pump Drives 34, 39 - 41
 - NEMA 4X AC Drives 35, 44
 - P2 Series Drives 34, 36 - 38
 - E3 Series Drives 35, 42, 43
 - Options 45
 - Sensorless Vector Drives 35, 42, 43
 - Single Phase Motor Drives 34, 46
 - Vector Drives 34, 36
- Application Notes
 - Electronic Line Shaft 29
 - Line Drive Coordination 29, 32
 - Process Line Coordination 29 - 31
 - Registration 29
 - Winder Controls 28
- Apps Packages 26 - 32
- Automation Technology 3 - 33
- C
 - Cam Profile 30
 - Configuration Tools 7-11
- D
 - DC Drives
 - 3-phase Regen 52
 - 3-phase System Drives 52
 - Digital 52
 - Single Phase 48 - 50
 - Single Phase Enclosed 50
 - Single-Phase Regen 49
 - SL Series 57
 - Distributed Control 6
 - drive.web
 - Application Solutions 26 - 33
 - Concept 3, 4, 5
 - Connectivity 4, 5
 - Model Numbers 14, 15, 24, 25, 27
 - Products 7
 - savvyPanel dw260 13
 - savvy software 9 - 12, 28 - 33
 - smarty dw250 14 - 19
 - smarty dw240 20 - 22
 - smarty dw210 24
 - speedy 23, 24
 - Systems 4, 5, 6
 - drive.web Automation 3 - 33
 - drive.web controllers 14 - 24
 - drive.web Line Control 28, 29, 32
- E
 - E3 Series Drives 42
 - E3 Series Single Phase Drives 46
 - ECO Drives 39
 - Electronic Line Shaft 29
 - Email Function Block 33
 - Energy Efficient Drives 39
 - Engineered Apps 26 - 29
- F
 - Fan & pump drives 40
 - 600 Volts Drives 41
 - Field Service 59
 - Flux Vector Drives 34, 36
 - Frequency I/O 14, 23
- G
 - General Purpose VFDs 35, 42
 - Get savvy download 9
- H
 - HVAC drives 40
 - 600 Volts Drives 41
- I
 - iOS, iPad, iPhone
 - savvyPanel 12
- K
 - Line Reactors 57
- L
 - Modulus
 - Enclosed Drive Systems 58
 - Modulus Packaged Drive Systems 58
 - Motion Control 30, 31
 - Cam Profile 30
 - Stepper Drive Control 31
 - Trapezoidal Motion 30
 - Motors, AC 58
 - Motors, DC 58
- N
 - NEMA 4X drives 44
 - NEMA 12 drives 36, 39
- O
 - Online Support 58
 - Open Loop Vector Drives 36
 - Operator Station
 - savvyPanel 12
- P
 - P2 Series Drives 36
 - Packaged Modulus Drive Systems 58
 - PL/X Series Digital DC Drives 52
 - Power Quality 57
 - Process Line Coordination 29, 30, 31
 - Programming Tools 12
 - Pump drives 40
- R
 - Regenerative Drives
 - Digital DC 52
 - Registration Control 29
- S
 - savvyPanel Touch Screens 13
 - savvy programming 11
 - savvy-SFD Signal Flow Diagram 10
 - savvy software 8 - 13, 28 - 33
 - savvy software download 9
 - Sensorless Vector Drives 36, 42, 43
 - Service 54, 59
 - Service Charges 59
 - Servo Drives 41
 - smarty Controller 14 - 22
 - speedy Controller 23, 24
 - Stepper Drive Control 31, 33
 - System Design Tools 7-11
 - Systems 6, 58
- T
 - Temperature Control 18
 - Terms Sale & Payment 59
 - Training Seminars 59
 - Transformers, Drive Isolating 57
 - Trapezoidal Motion 30
- V
 - V3 Energy Efficient 39
 - Variable Torque Drives 40
 - Vector Drives 36
 - 600 Volts Drives 38, 40
- W
 - WiFi Roaming 33
 - Winder Controls 28
 - drive.web smarty
 - Dancer controlled 28
 - Load cell controlled 28
 - Open loop CTCW 28